

LWW-MN

HIGH-OUTPUT MINI LED WALL WASHER

Project _____
Location _____
Quote/ Ref # _____

LWW-MN Linear Wall washer series is a powerful LED flood light typically used for building facades, signs or any wall washing applications. Variety of optical lens options provides endless lighting solutions. Available in narrow, medium, wide and elliptical optic options.



SPECIFICATIONS

INPUT VOLTAGE	24V DC
OPERATING FREQUENCY	50/ 60 Hz
POWER CONSUMPTION	6W/ Ft.
LUMEN OUTPUT	110 Lm/W
CRI	90+
COLOR TEMPERATURE	27K / 30K / 35K / 40K / 50K / 60K RD / GN / BL / AM
DIMMING	0-10V
MAX RUN	Linkable up to 20 ft.
OPERATING TEMPERATURE	-40°F TO 185°F (-40°C TO 85°C)
STORAGE TEMPERATURE	-40°F TO 122°F (-40°C TO 50°C)
BEAM ANGLE	20° / 40° / 60° / 20°x40°
IP RATING	IP66 wet location (outdoor)
LUMEN MAINTENANCE	50,000 Hrs.

FEATURES

- 90+ CRI
- 110 Lumens per Watt
- Linkable up to 20Ft.
- Proprietary Optical Technology
- TRIAC Dimming
- Proprietary Adjustable Mounting Bracket
- Facade Wall Washing
- Graze Lighting
- Signage



MODEL	LENGTH	COLOR TEMP		OPTICS	OPTIONS	VOLTAGE	
LWWMN	20 20" (9W)	27K	RD	20 20°	FMB	24 24V DC	
		30K	GN		Fixed Mounting Bracket		
	40 40" (18W)	35K	BL	40 40°	STB		
		40K	AM		Standard Tilting Bracket		
		50K			60 60°		ETB
		60K					Extended Tilting Bracket
			20x40 20° x 40°	STK	Mounting Stake		

LWW-MN

HIGH-OUTPUT MINI LED WALL WASHER

DIMENSIONS

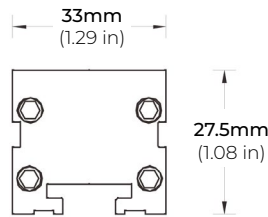

OPTICS

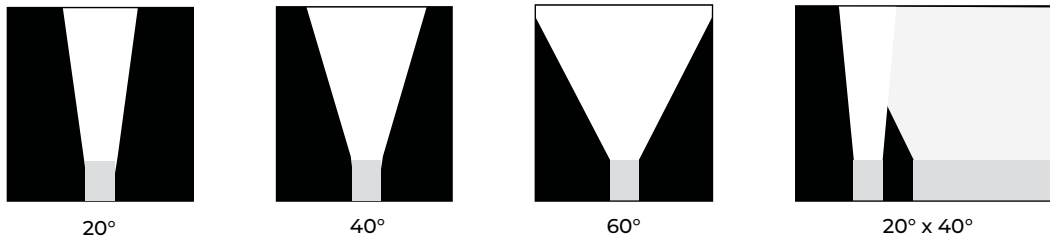

MOUNTING ACCESSORIES

LWW-MN-FMB FIXED MOUNTING BRACKET

*Sold Separately

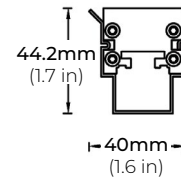

LWW-MN-STB STANDARD TILTING BRACKET

*Included with every Fixture

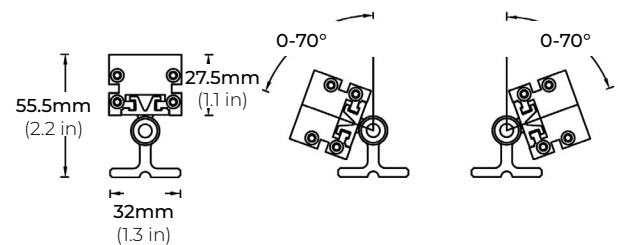

LWW-MN-ETB EXTENDED TILTING BRACKET

*Sold Separately

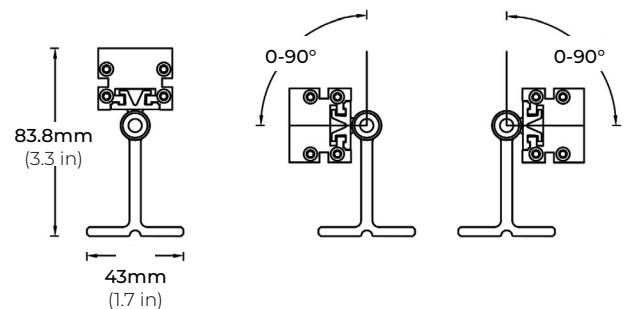

LWW-MN

HIGH-OUTPUT MINI LED WALL WASHER

MOUNTING ACCESSORIES

LWW-MN-STK
MOUNTING STAKE

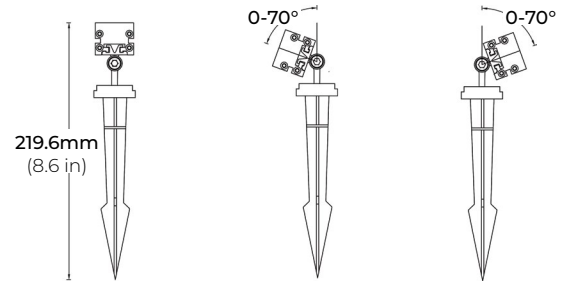

COMPATIBLE ACCESSORIES

LWW-EC
END CAP
*Sold Separately

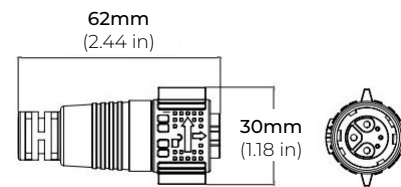

LWW-MN-20-ADLV
LWW-MN-40-ADLV
20" AND 40" ASYMMETRIC LOUVER
*Sold Separately

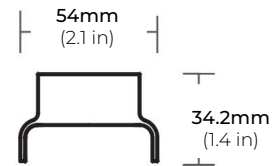
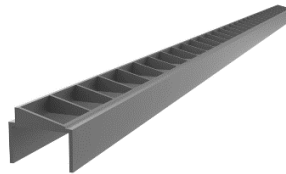

LWW-MN-20-SDLV
LWW-MN-40-SDLV
20" AND 40" SYMMETRIC LOUVER
*Sold Separately

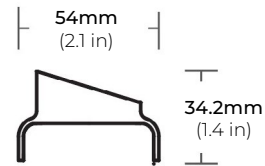
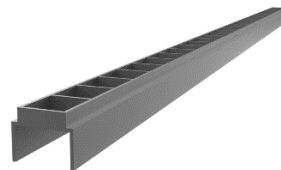

LWW-MN-LNK-10
LWW-MN-LNK-36
LWW-MN-LNK-72
10", 36", 72" LINK EXTENSION CABLE
*Sold Separately



LWW-MN-HWC-72-BK
72" HARDWIRE CABLE
*Sold Separately



HIGH-OUTPUT MINI LED WALL WASHER

COMPATIBLE TRANSFORMERS

PSDE SERIES

0-10V DIMMING W/ JUNCTION BOX

PSDE-60W-24V-010-JB	CLASS 2	12.1" X 2.36" X 1.4"
PSDE-96W-24V-010-JB	CLASS 2	12.1" X 2.36" X 1.4"

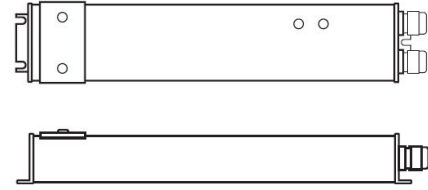

PSRX SERIES

4-IN-1 DIMMING DRIVER

PSRX-30W-24V	CLASS 2	6.5" X 3.72" X 1.57"
PSRX-60W-24V	CLASS 2	7.4" X 3.72" X 1.57"
PSRX-96W-24V	CLASS 2	8.66" X 3.72" X 1.57"
PSRX-150W-24V		10.24" X 4.13" X 1.77"
PSRX-192W-24V	CLASS 2	11" X 4" X 1.82"
PSRX-200W-24V		10.24" X 4.13" X 1.77"
PSRX-288W-24V	CLASS 2	11.85" X 4.25" X 1.82"
PSRX-300W-24V		10.94" X 4.33" X 1.77"

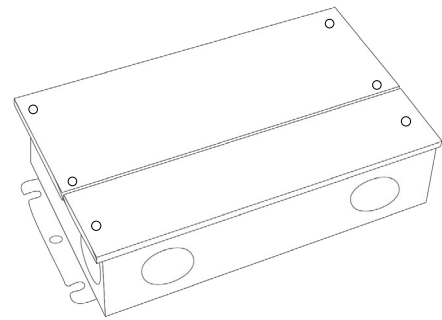

PSVT SERIES

0-10V DIMMING DRIVER

PSVT-60W-24V	CLASS 2	7.4" X 3.72" X 1.57"
PSVT-96W-24V	CLASS 2	8.66" X 3.72" X 1.57"
PSVT-200W-24V		10.24" X 4.13" X 1.77"
PSVT-288W-24V	CLASS 2	11.85" X 4.25" X 1.81"
PSVT-300W-24V		10.94" X 4.33" X 1.77"

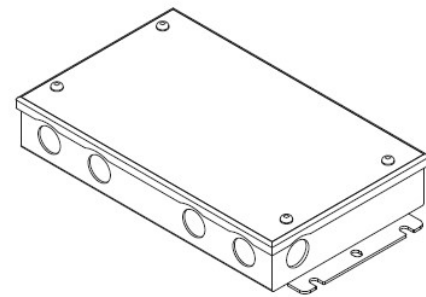

COMPATIBLE NON-DIMMING DRIVERS

PSHK SERIES

NON-DIMMING CONSTANT VOLTAGE WITH JUNCTION BOX

PSHK-30W-24V	CLASS 2	6.5" X 3.6" X 1.02"
PSHK-60W-24V	CLASS 2	7.4" X 3.62" X 1.02"
PSHK-96W-24V	CLASS 2	8.66" X 3.66" X 1.61"
PSHK-150W-24V		10.24" X 4.06" X 1.81"
PSHK-200W-24V		10.24" X 4.06" X 1.81"
PSHK-288W-24V	CLASS 2	11.85" X 4.25" X 1.82"
PSHK-300W-24V		10.24" X 4.25" X 1.81"

