

LNT-45WD

4W WARM-DIM FLEXIBLE NEON SERIES

Project _____

Location _____

Quote/ Ref # _____

LNT-45WD is a WARM-DIM high-performance flexible LED strip designed as a neon replacement. Suitable for indoor and outdoor applications, the LNT45WD automatically shifts color temperatures from 30K down to 18K as it is being dimmed. It easily bends around contours and tight curves without being damaged.

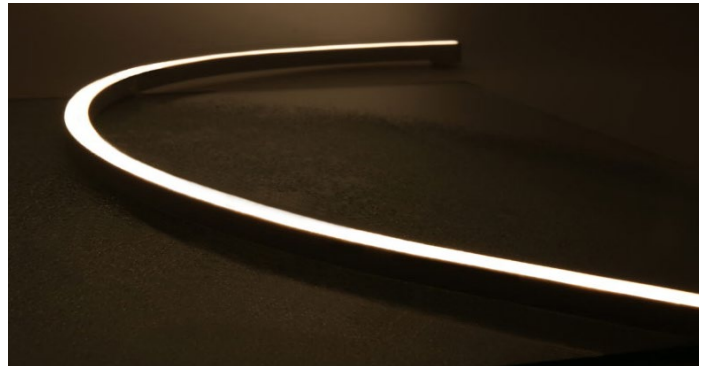

SPECIFICATIONS

INPUT VOLTAGE	24V DC Constant Voltage
POWER CONSUMPTION	4W per Ft.
LUMEN OUTPUT	104Lm/ Ft. (Flat) 134 Lm/ Ft. (Dome)
CRI	90
DIMMING/ CONTROL	MLV, ELV, 0-10 and TRIAC
MAXIMUM RUN LENGTH	29 Ft.
CUTTABLE	Every 83.31mm (3.28 in)
POWER FACTOR	≤ 1
STORAGE TEMPERATURE	-40°F (-40°C) to 140°F (60°C)
OPERATING TEMPERATURE	-40°F (-40°C) to 131°F (55°C)
BEAM ANGLE	111.4° (Flat) 270° (Dome)
HUMIDITY	0-95% Non Condensing
IP RATING	IP67/ IP68
CERTIFICATIONS	UL Listed
LUMEN MAINTENANCE	50,000 Hrs.

FEATURES

- Auto warm-dim technology
- Smooth illumination
- Bottom, Side & End Feed options
- Continuous run length up to 29 Ft.
- Dimmable with CORE dimmable drivers
- Bottom, Side and End Feed options
- UL Listed (US and Canada)



MODEL	LENS	COLOR TEMP	VOLTAGE	LENGTH	POWER FEED	FEED LENGTH
LNT-45	F Flat	18/30K 1800K / 3000K	24 24V DC	Please refer to pages 4-5 for exact lengths with corresponding ordering codes.	BF Bottom Feed	HW3 3 Ft. Power Feed
					EF End Feed	HW10 10 Ft. Power Feed
	SFL Side Feed Left				HW16 16 Ft. Power Feed	
	SFR Side Feed Right				HW32 32 Ft. Power Feed	
					HW50 50 Ft. Power Feed	

LNT-45WD

4W WARM-DIM FLEXIBLE NEON SERIES

DIMENSIONS

<p>11.5mm (0.45 in)</p> <p>21mm (0.83 in)</p> <p>FLAT LENS</p>	<p>11.5mm (0.45 in)</p> <p>29mm (1.14 in)</p> <p>DOME LENS</p>	<p>LIGHT SOURCE</p> <p>Ø 120mm (4.27 in)</p>	<p>30.5mm (1.2 in)</p> <p>11.9mm (0.47 in)</p> <p>~ 127mm (5 in)</p>
<p>HORIZONTAL BEND</p>		<p>BEND DIAMETER</p>	<p>POWER FEED CHOKER</p>
<p>LIGHT SOURCE</p> <p>LIGHT SOURCE</p>		<p>LED strip only bends along horizontal axis. Bending the LED strip vertically (perpendicular) to the light surface risks damage to the LED strip. Do NOT bend more than the indicated bend radius (shown above). Doing so will damage the LED strip.</p>	<p>All CORE Lighting IP67/IP68 Neons include a choker that sits roughly 5" from the end of the Neon.</p> <p><i>*Warranty is void if removed.</i></p>

COMPATIBLE ACCESSORIES

SELF LOCKING ALUMINUM PROFILE

LNT45-AC2
2" PROFILE

LNT45-AC39
39" PROFILE

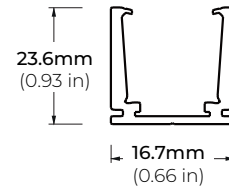

FLEXIBLE ALUMINUM CHANNEL

LNT45-AFX
39" CHANNEL

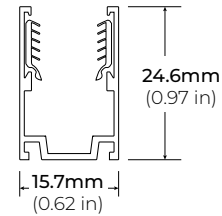
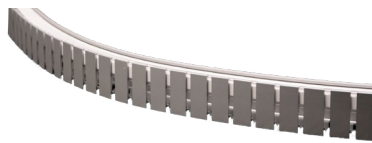

PLASTIC PROFILE

LNT45-PC39
39" PROFILE

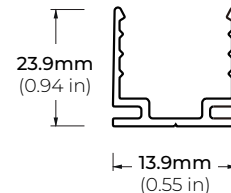
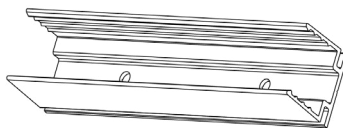

LNT45-BKT-ADJ
ADJUSTABLE BRACKET

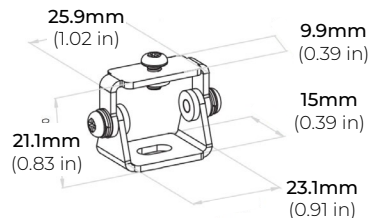

LNT-45WD

4W WARM-DIM FLEXIBLE NEON SERIES

POWER FEED

FLAT

DOME

EF
END FEED

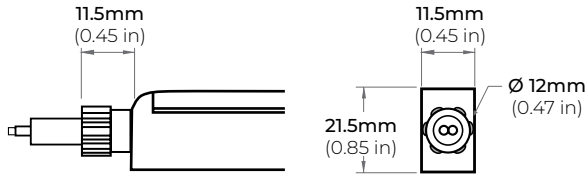

SFL
SIDE FEED LEFT

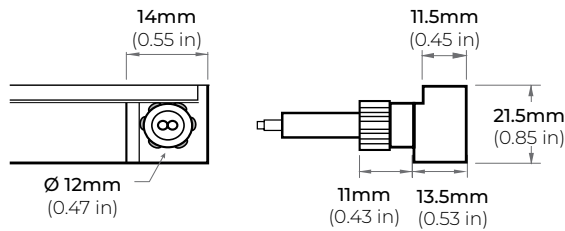

SFR
SIDE FEED RIGHT

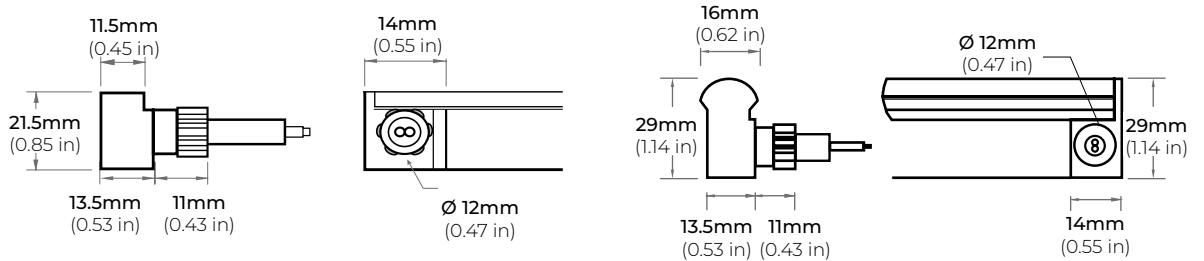

BF
BOTTOM FEED

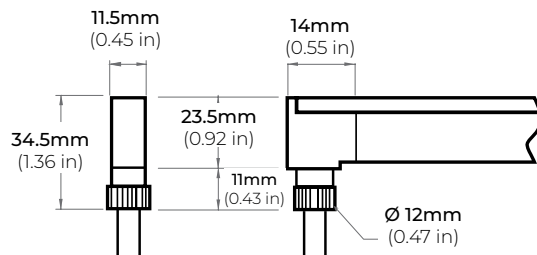

EC
END CAP

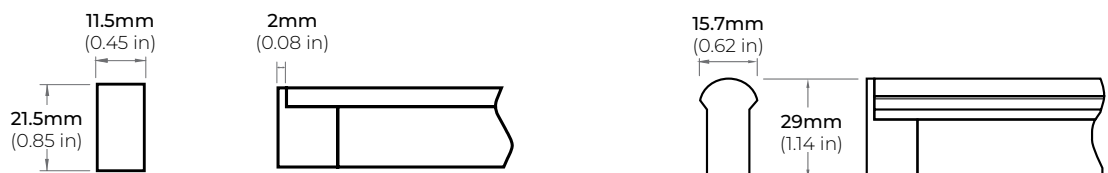

LNT-45WD

4W WARM-DIM FLEXIBLE NEON SERIES

CUTTING LENGTH CODES

LNT-45 WD is cuttable every 3.28" (8.33CM). Please refer to the chart below to determine actual lengths once LED is cut versus actual lengths required or specified.

Total Length Calculation = Order Code Length + End Feed option Length

Example: 50.3" Total Length = Order Code 15 (49.2") + (1.1") End Feed

POWER FEED OPTION	
END FEED	1.1"
BOTTOM FEED	0.20"
SIDE FEED	0.20"

CUTTING LENGTH INCREMENT TABLE

CODE	LENGTH (CM)	LENGTH (IN)
1	8.33	3.28
2	16.66	6.56
3	24.99	9.84
4	33.32	13.12
5	41.65	16.4
6	49.98	19.68
7	58.31	22.96
8	66.64	26.24
9	74.97	29.52
10	83.3	32.8
11	91.63	36.08
12	99.96	39.36
13	108.29	42.64
14	116.62	45.92
15	124.95	49.2
16	133.28	52.48
17	141.61	55.76
18	149.94	59.04
19	158.27	62.32
20	166.6	65.6
21	174.93	68.88
22	183.26	72.16
23	191.59	75.44
24	199.92	78.72
25	208.25	82
26	216.58	85.28
27	224.91	88.56
28	233.24	91.84
29	241.57	95.12
30	249.9	98.4
31	258.23	101.68
32	266.56	104.96
33	274.89	108.24
34	283.22	111.52
35	291.55	114.8
36	299.88	118.08
37	308.21	121.36
38	316.54	124.64
39	324.87	127.92
40	333.2	131.2

CODE	LENGTH (CM)	LENGTH (IN)
41	341.53	134.48
42	349.86	137.76
43	358.19	141.04
44	366.52	144.32
45	374.85	147.6
46	383.18	150.88
47	391.51	154.16
48	399.84	157.44
49	408.17	160.72
50	416.5	164
51	424.83	167.28
52	433.16	170.56
53	441.49	173.84
54	449.82	177.12
55	458.15	180.4
56	466.48	183.68
57	474.81	186.96
58	483.14	190.24
59	491.47	193.52
60	499.8	196.8
61	508.13	200.08
62	516.46	203.36
63	524.79	206.64
64	533.12	209.92
65	541.45	213.2
66	549.78	216.48
67	558.11	219.76
68	566.44	223.04
69	574.77	226.32
70	583.1	229.6
71	591.43	232.88
72	599.76	236.16
73	608.09	239.44
74	616.42	242.72
75	624.75	246
76	633.08	249.28
77	641.41	252.56
78	649.74	255.84
79	658.07	259.12
80	666.4	262.4

CODE	LENGTH (CM)	LENGTH (IN)
81	674.73	265.68
82	683.06	268.96
83	691.39	272.24
84	699.72	275.52
85	708.05	278.8
86	716.38	282.08
87	724.71	285.36
88	733.04	288.64
89	741.37	291.92
90	749.7	295.2
91	758.03	298.48
92	766.36	301.76
93	774.69	305.04
94	783.02	308.32
95	791.35	311.6
96	799.68	314.88
97	808.01	318.16
98	816.34	321.44
99	824.67	324.72
100	833	328
101	841.33	331.28
102	849.66	334.56
103	857.99	337.84
104	866.32	341.12
105	874.65	344.4
106	882.98	347.68
107	891.31	350.96
108	899.64	354.24
109	907.97	357.52
110	916.3	360.8
111	924.63	364.08
112	932.96	367.36
113	941.29	370.64
114	949.62	373.92
115	957.95	377.2
116	966.28	380.48
117	974.61	383.76
118	982.94	387.04
119	991.27	390.32
120	999.6	393.6

LNT-45WD

4W WARM-DIM FLEXIBLE NEON SERIES

CUTTING LENGTH CODES

LNT-45 WD is cuttable every **3.28" (8.33CM)**. Please refer to the chart below to determine actual lengths once LED is cut versus actual lengths required or specified.

Total Length Calculation = Order Code Length + End Feed option Length

Example: 50.3" Total Length = Order Code 15 (49.2") + (1.1") End Feed

POWER FEED OPTION	
END FEED	1.1"
BOTTOM FEED	0.20"
SIDE FEED	0.20"

CUTTING LENGTH INCREMENT TABLE

CODE	LENGTH (CM)	LENGTH (IN)
121	1007.93	396.88
122	1016.26	400.16
123	1024.59	403.44
124	1032.92	406.72
125	1041.25	410
126	1049.58	413.28
127	1057.91	416.56
128	1066.24	419.84
129	1074.57	423.12
130	1082.9	426.4
131	1091.23	429.68
132	1099.56	432.96
133	1107.89	436.24
134	1116.22	439.52
135	1124.55	442.8
136	1132.88	446.08
137	1141.21	449.36
138	1149.54	452.64
139	1157.87	455.92
140	1166.2	459.2
141	1174.53	462.48
142	1182.86	465.76
143	1191.19	469.04
144	1199.52	472.32
145	1207.85	475.6
146	1216.18	478.88

LNT-45WD

4W WARM-DIM FLEXIBLE NEON SERIES

COMPATIBLE TRANSFORMERS

PSDL SERIES TRIAC DIMMABLE

PSDL-30W-24V	CLASS 2	6.5" X 3.63" X 1.03"
PSDL-60W-24V	CLASS 2	7.4" X 3.63" X 1.03"
PSDL-96W-24V	CLASS 2	8.67" X 3.67 X 1.62"
PSDL-150W-24V		8.67" X 3.67" X 1.62"
PSDL-192W-24V	CLASS 2	10.25" X 4.06" X 1.82"
PSDL-200W-24V		10.25" X 4.06" X 1.82"
PSDL-288W-24V	CLASS 2	10.25" X 4.06" X 1.82"
PSDL-300W-24V		10.25" X 4.06" X 1.82"

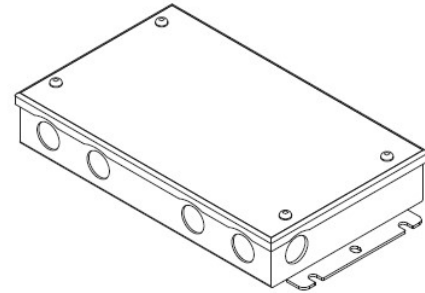

PSDH SERIES HIGH PERFORMANCE MAGNETIC LOW VOLTAGE (MLV)

PSDH-48W-24V	CLASS 2	11.25" X 3.37" X 3.25"
PSDH-96W-24V	CLASS 2	11.25" X 3.37" X 3.25"
PSDH-288W-24V	CLASS 2	14.25" X 8.43" X 4.43"

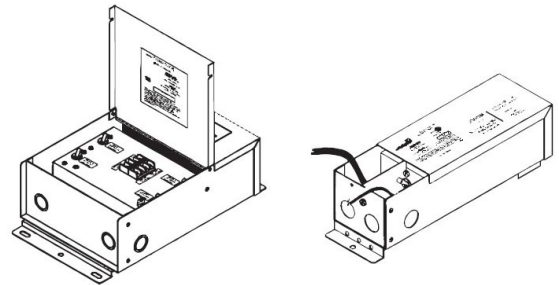

PSRX SERIES 4-IN-1 DIMMING DRIVER

PSRX-30W-24V	CLASS 2	6.5" X 3.72" X 1.57"
PSRX-60W-24V	CLASS 2	7.4" X 3.72" X 1.57"
PSRX-96W-24V	CLASS 2	8.66" X 3.72" X 1.57"
PSRX-150W-24V		10.24" X 4.13" X 1.77"
PSRX-192W-24V	CLASS 2	11" X 4" X 1.82"
PSRX-200W-24V		10.24" X 4.13" X 1.77"
PSRX-288W-24V	CLASS 2	11.85" X 4.25" X 1.82"
PSRX-300W-24V		10.94" X 4.33" X 1.77"

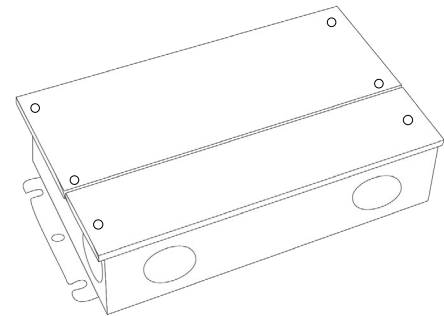

PSVT SERIES 0-10V DIMMING DRIVER

PSVT-60W-24V	CLASS 2	7.4" X 3.72" X 1.57"
PSVT-96W-24V	CLASS 2	8.66" X 3.72" X 1.57"
PSVT-200W-24V		10.24" X 4.13" X 1.77"
PSVT-288W-24V	CLASS 2	11.85" X 4.25" X 1.81"
PSVT-300W-24V		10.94" X 4.33" X 1.77"

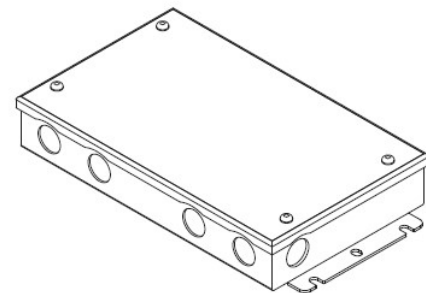

LNT-45WD

4W WARM-DIM FLEXIBLE NEON SERIES

COMPATIBLE TRANSFORMERS

PSDE SERIES 0-10V DIMMING W/ JUNCTION BOX

PSDE-60W-24V-010-JB	CLASS 2	12.1" X 2.36" X 1.4"
PSDE-96W-24V-010-JB	CLASS 2	12.1" X 2.36" X 1.4"

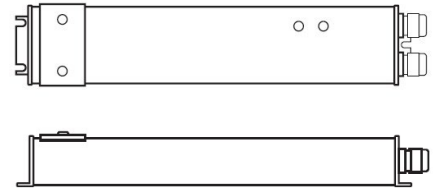

LUTRON 1% 3-WIRE DIMMING

L3DA4U1UKL-CV240	CLASS 2	4.89" X 4" X 2.62"
------------------	---------	--------------------

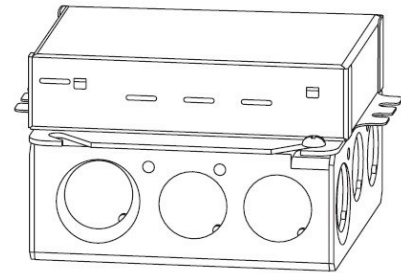

PSDE-96W-24V-ECO	CLASS 2	10.5" X 3.0" X 2.0"
------------------	---------	---------------------

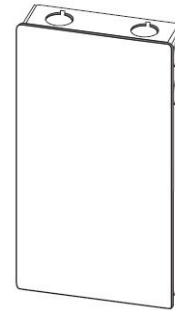

COMPATIBLE NON-DIMMING DRIVERS

PSHK SERIES NON-DIMMING CONSTANT VOLTAGE WITH JUNCTION BOX

PSHK-30W-24V	CLASS 2	6.5" X 3.6" X 1.02"
PSHK-60W-24V	CLASS 2	7.4" X 3.62" X 1.02"
PSHK-96W-24V	CLASS 2	8.66" X 3.66" X 1.61"
PSHK-150W-24V		10.24" X 4.06" X 1.81"
PSHK-200W-24V		10.24" X 4.06" X 1.81"
PSHK-288W-24V	CLASS 2	11.85" X 4.25" X 1.82"
PSHK-300W-24V		10.24" X 4.25" X 1.81"

