

LNT-45 RGBW

4.4W IP67/68 FLEXIBLE COLOR-CHANGING + WHITE LED STRIP

Project _____

Location _____

Quote/ Ref # _____

LNT-45 RGBW is a high performance flexible LED fixture designed as a neon replacement. Suitable for indoor and outdoor applications, the LNT45RGBW easily bends around contours and tight curves without being damaged. It allows for easy installation with its factory sealed terminators and self-locking male and female barrel connectors.



SPECIFICATIONS

INPUT VOLTAGE	24V DC Constant Voltage
POWER CONSUMPTION	4.4W per Ft.
LUMEN OUTPUT	140Lm/ Ft. (Flat) 105Lm/ Ft. (Dome)
CRI	88+
COLOR TEMPERATURE	RGB+27K/ RGB+40K
DIMMING/ CONTROL	Through RGBW Controller
MAXIMUM RUN LENGTH	32 Ft.
CUTTABLE	Every 100.1mm (3.94 in)
POWER FACTOR	≤1
STORAGE TEMPERATURE	-40°F (-40°C) to 140°F (60°C)
OPERATING TEMPERATURE	-40°F (-40°C) to 131°F (55°C)
BEAM ANGLE	160° (Flat) 270° (Dome)
HUMIDITY	0-95% Non Condensing
IP RATING	IP67/ IP68
CERTIFICATIONS	UL Listed
LUMEN MAINTENANCE	50,000 Hrs.

FEATURES

- High Color Consistency
- Smooth Illumination
- Waterproof, Submersible under water
- Bottom, Side and End Feed options
- Continuous run length up to 32 Ft.
- UL Listed (US and Canada)



MODEL	LENS	COLOR TEMP	VOLTAGE	LENGTH	POWER FEED	FEED LENGTH
LNT-45	F Flat	RGBW27K RGB+2700K	24 24V DC	Please refer to page 4 for exact lengths with corresponding ordering codes.	BF Bottom Feed	HW3 3 Ft. power feed
	D Dome	RGBW40K RGB+4000K			SFL Side Feed Left	HW10 10 Ft. power feed
					SFR Side Feed Right	HW16 16 Ft. power feed
					EF End Feed	HW32 32 Ft. power feed
					HW50 50 Ft. power feed	

LNT-45 RGBW

4.4W IP67/68 FLEXIBLE COLOR-CHANGING + WHITE LED STRIP

DIMENSIONS

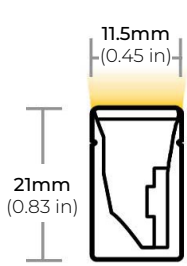

FLAT LENS

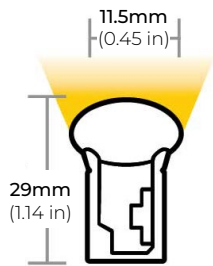

DOME LENS

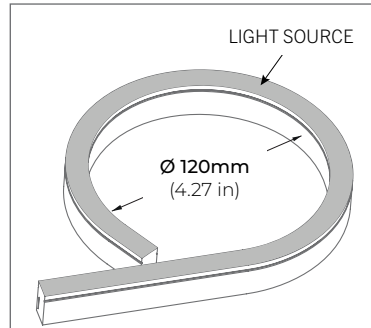

BEND DIAMETER

LED strip only bends along horizontal axis. Bending the LED strip vertically (perpendicular) to the light surface risks damage to the LED strip. Do **NOT** bend more than the indicated bend radius (shown above). Doing so will damage the LED strip.

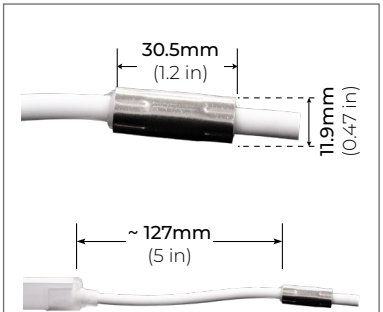

POWER FEED CHOKER

All CORE Lighting IP67/IP68 Neons include a choker that sits roughly 5" from the end of the Neon.

*Warranty is void if removed.

HORIZONTAL BEND

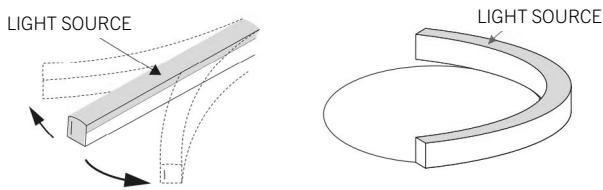

COMPATIBLE ACCESSORIES

SELF LOCKING ALUMINUM PROFILE

LNT45-AC2
2" PROFILE

LNT45-AC39
39" PROFILE

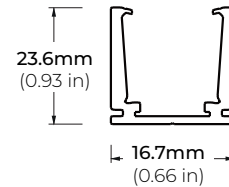

FLEXIBLE ALUMINUM CHANNEL

LNT45-AFX
39" CHANNEL

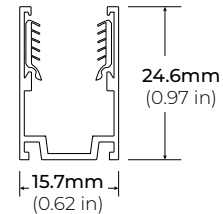
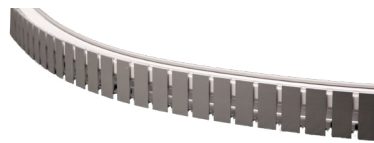

PLASTIC PROFILE

LNT45-PC39
39" PROFILE

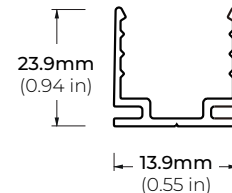
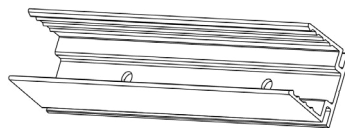

LNT45-BKT-ADJ
ADJUSTABLE BRACKET

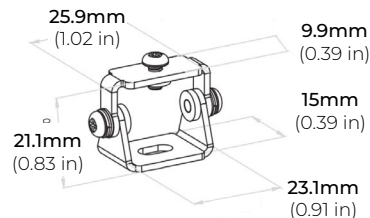

LNT-45 RGBW

4.4W IP67/68 FLEXIBLE COLOR-CHANGING + WHITE LED STRIP

POWER FEED

FLAT

DOME

EF
END FEED

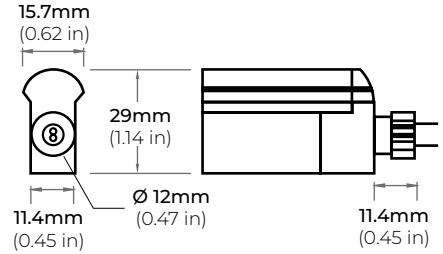
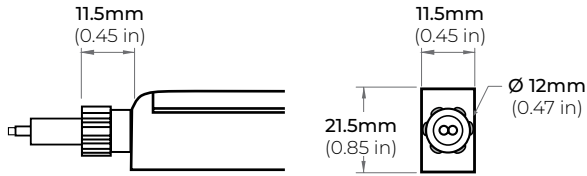

SFL
SIDE FEED LEFT

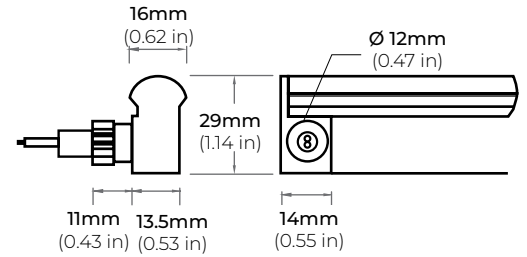
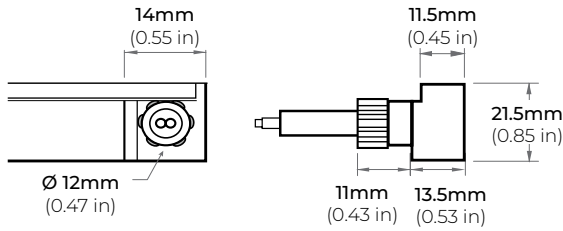

SFR
SIDE FEED RIGHT

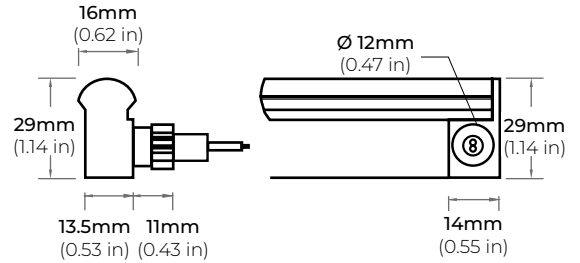
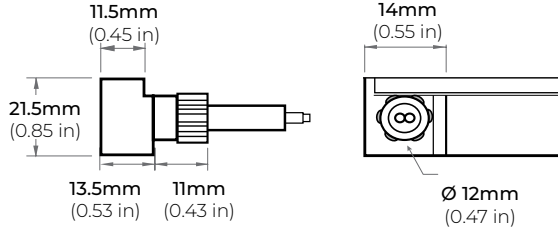

BF
BOTTOM FEED

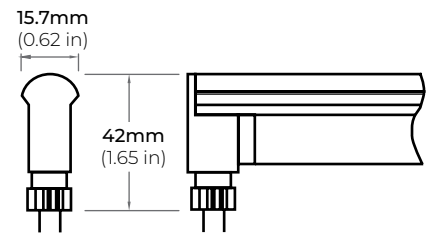
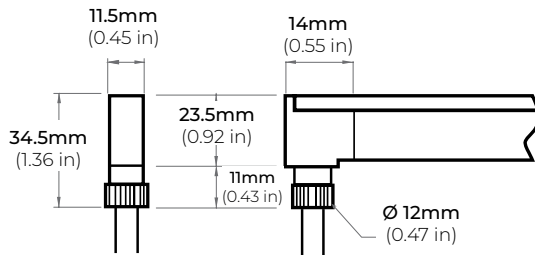

EC
END CAP

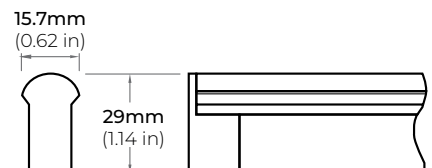
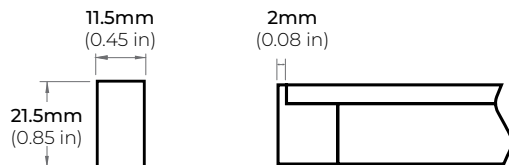

LNT-45 RGBW

4.4W IP67/68 FLEXIBLE COLOR-CHANGING + WHITE LED STRIP

CUTTING LENGTH CODES

LNT-45 RGBW is cuttable every **3.94" (10CM)**. Please refer to the chart below to determine actual lengths once LED is cut versus actual lengths required or specified.

Total Length Calculation = Order Code Length + End Feed option Length

Example: 60.2" Total Length = Order Code 15 (59.1") + (1.1") End Feed

POWER FEED OPTION	
END FEED	1.1"
BOTTOM FEED	0.20"
SIDE FEED	0.20"

CUTTING LENGTH INCREMENT TABLE

CODE	LENGTH (CM)	LENGTH (IN)
1	10	3.94
2	20	7.88
3	30	11.82
4	40	15.76
5	50	19.7
6	60	23.64
7	70	27.58
8	80	31.52
9	90	35.46
10	100	39.4
11	110	43.34
12	120	47.28
13	130	51.22
14	140	55.16
15	150	59.1
16	160	63.04
17	170	66.98
18	180	70.92
19	190	74.86
20	200	78.8
21	210	82.74
22	220	86.68
23	230	90.62
24	240	94.56
25	250	98.5
26	260	102.44
27	270	106.38
28	280	110.32
29	290	114.26
30	300	118.2
31	310	122.14
32	320	126.08
33	330	130.02
34	340	133.96
35	350	137.9
36	360	141.84
37	370	145.78
38	380	149.72
39	390	153.66
40	400	157.6

CODE	LENGTH (CM)	LENGTH (IN)
41	410	161.54
42	420	165.48
43	430	169.42
44	440	173.36
45	450	177.3
46	460	181.24
47	470	185.18
48	480	189.12
49	490	193.06
50	500	197
51	510	200.94
52	520	204.88
53	530	208.82
54	540	212.76
55	550	216.7
56	560	220.64
57	570	224.58
58	580	228.52
59	590	232.46
60	600	236.4
61	610	240.34
62	620	244.28
63	630	248.22
64	640	252.16
65	650	256.1
66	660	260.04
67	670	263.98
68	680	267.92
69	690	271.86
70	700	275.8
71	710	279.74
72	720	283.68
73	730	287.62
74	740	291.56
75	750	295.5
76	760	299.44
77	770	303.38
78	780	307.32
79	790	311.26
80	800	315.2

CODE	LENGTH (CM)	LENGTH (IN)
81	810	319.14
82	820	323.08
83	830	327.02
84	840	330.96
85	850	334.9
86	860	338.84
87	870	342.78
88	880	346.72
89	890	350.66
90	900	354.6
91	910	358.54
92	920	362.48
93	930	366.42
94	940	370.36
95	950	374.3
96	960	378.24
97	970	382.18
98	980	386.12
99	990	390.06
100	1000	394

LNT-45 RGBW

4.4W IP67/68 FLEXIBLE COLOR-CHANGING + WHITE LED STRIP

UPDATED: 03.17.25

DMX CONTROLLERS

RGB CT600

MULTI-FUNCTION RGBW WALL CONTROLLER

INPUT VOLTAGE	5V DC, 1A
OUTPUT SIGNAL	RF 2.4GHZ + DMX512
CONTROL	4 ZONES
COLOR OPTIONS	Black/ White
WORKING TEMP	-20°C ~ 40°C
DIMENSIONS	LxWxH (5.19"x7.08"x1.38")

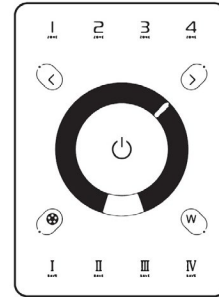

RGB-SCW4

WiFi DMX WALL CONTROLLER

INPUT VOLTAGE	5 - 10V DC, 06A
OUTPUT SIGNAL	DMX512 (x2)
PROGRAMMABILITY	PC/ MAC
COLOR OPTIONS	Black/ White
CONNECTIONS	USB/ 8dry contact ports/ Open drain output (for relay)
MEMORY	Built-In Flash
WORKING TEMP	-10°C ~ 45°C
DIMENSIONS	LxWxH (5.75"x4.17"x0.43")

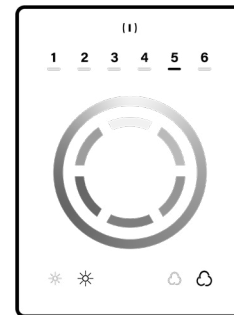

RGB-SDE3

WiFi DMX WALL CONTROLLER

INPUT VOLTAGE	6V DC, 0.6A
OUTPUT SIGNAL	DMX512 (x2)
PROGRAMMABILITY	PC/ MAC/ Tablet/ Smartphone
COLOR OPTIONS	Black/ White
CONNECTIONS	USB/ Ethernet/ RS232/ CLock/ 8dry contact ports/ 5V output relay
MEMORY	MicroSD Card
WORKING TEMP	-20°C ~ 40°C
DIMENSIONS	LxWxH (5.75"x4.17"x0.43")

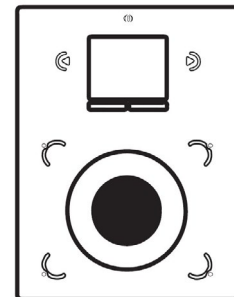

LNT-45 RGBW

4.4W IP67/68 FLEXIBLE COLOR-CHANGING + WHITE LED STRIP

UPDATED: 03.17.25

DMX DECODERS

RGB-DMX-4C-RJ45 4-CHANNEL DMX DECODER

INPUT VOLTAGE 12V-24V DC
OUTPUT CURRENT 8A X 4CH
OUTPUT WATTAGE 4 x (96W ~ 288W)
OUTPUT CHANNELS 4
DIMENSIONS LxWxH (6.5"x2.38"x1.27")

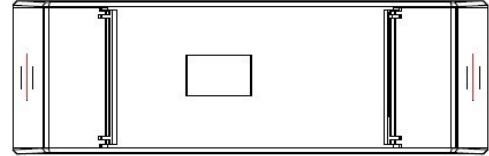

RGB-DMX-5C-XLR 5-CHANNEL DMX DECODER

INPUT VOLTAGE 12V-24V DC
OUTPUT CURRENT 8A X 5CH
OUTPUT WATTAGE 5 x (96W ~ 192W)
OUTPUT CHANNELS 5
DIMENSIONS LxWxH (6.45"x2.87"x1.5")

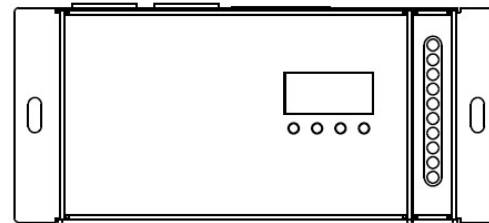

LNT-45 RGBW

4.4W IP67/68 FLEXIBLE COLOR-CHANGING + WHITE LED STRIP

NON-DMX CONTROLLERS

RGB-CT550

RGBW WIRELESS RECEIVER / CONTROLLER SYSTEM

REMOTE DISTANCE 100 Ft. (Line of Sight)
FREQUENCY 2.4 GHz
DIMENSIONS LxWxH (6.38"x1.65"x0.59")
WEIGHT 0.44lbs.

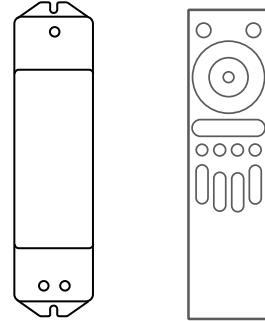

* RGB-CT500-RX
(Sold Separately)

RGB-CT550-RX

RGBW WIRELESS RECEIVER / CONTROLLER SYSTEM

INPUT VOLTAGE DC5V ~ DC24V
POWER CAPACITY 100W (5V) | 240W (12V) | 480W (24V)
OUTPUT CURRENT 5A per Channel (20A Total)
WORKING TEMP -30°C~55°C (-22°F~131°F)
DIMENSIONS LxWxH (6.89"x1.73"x1.18")

* RGB-CT500-RX (Sold Separately)

RGB-CT700

MASTER RGBW WIFI CONTROLLER

INPUT VOLTAGE 12-24V DC
OUTPUT TYPE Constant Voltage
POWER CAPACITY 288W (12V) | 384W (24V)
OUTPUT CURRENT 5A per Channel (20A Total)
WORKING TEMP -4°F (-20°C) ~ 122°F (50°C)
DIMENSIONS LxWxH (7 x1.8 x 0.8")

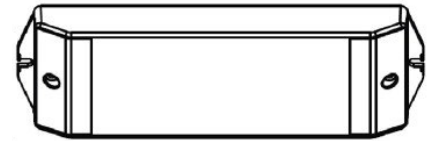

* Paired with RGB-CT705ZR (Sold Separately)

RGB-CT705ZR

SLAVE RGBW WIFI CONTROLLER

INPUT VOLTAGE 12-24V DC
OUTPUT TYPE Constant Voltage
POWER CAPACITY 288W (12V) | 384W (24V)
OUTPUT CURRENT 5A per Channel (20A Total)
WORKING TEMP -4°F (-20°C) ~ 122°F (50°C)
DIMENSIONS LxWxH (7 x0,63 x 0.71")

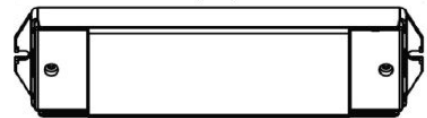

* Paired with RGB-CT700 (Sold Separately)

LNT-45 RGBW

4.4W IP67/68 FLEXIBLE COLOR-CHANGING + WHITE LED STRIP

UPDATED: 03.17.25

NON-DMX CONTROLLERS (CONTINUED)

RGB-CT840 BLUETOOTH TOUCH PANEL WALL CONTROLLER

INPUT VOLTAGE	12-24V DC
ZONES	4
CONTROL MODE	RGB RGBW
WIRELESS PROTOCOL	Bluetooth 5.0 SIG Mesh
WORKING TEMP	-20°C ~ 55°C
DIMENSIONS	LxWxH (4.7"x3"x1.2")

** Paired with RGB-CT800-RC (Sold Separately)*



RGB-CT800-RC BLUETOOTH CONSTANT VOLTAGE LED RECEIVER

INPUT VOLTAGE	12V 24V
OUTPUT CURRENT	4Ax5CH / 5Ax4CH (20A Max)
POWER CAPACITY	240W (12V) 480W (24V)
PROGRAMMABILITY	iOS and Android
WORKING TEMP	-20°C ~ 55°C
DIMENSIONS	LxWxH (6.9 x1.7 x 1.2")

** Paired with RGB-CT840 (Sold Separately)*



LNT-45 RGBW

4.4W IP67/68 FLEXIBLE COLOR-CHANGING + WHITE LED STRIP

UPDATED: 03.17.25

NON-DIMMING DRIVERS (COMPATIBLE WITH ALL SYSTEMS)

PSHK SERIES

NON-DIMMING CONSTANT VOLTAGE WITH JUNCTION BOX

PSHK-30W-24V	CLASS 2	6.5" X 3.6" X 1.02"
PSHK-60W-24V	CLASS 2	7.4" X 3.62" X 1.02"
PSHK-96W-24V	CLASS 2	8.66" X 3.66" X 1.61"
PSHK-150W-24V		10.24" X 4.06" X 1.81"
PSHK-200W-24V		10.24" X 4.06" X 1.81"
PSHK-288W-24V	CLASS 2	11.85" X 4.25" X 1.82"
PSHK-300W-24V		10.24" X 4.25" X 1.81"

