

LNT-65

3.4W IP67/68 FLEXIBLE LED NEON SERIES

Project _____
Location _____
Quote/ Ref # _____

The **LNT65** is a high performance flexible LED fixture designed as a neon replacement and is also useful in a wide variety of indoor or outdoor applications where a smooth surface or continuous line of light is desired. It is a flexible strip light that can bend around contours or tight curves horizontally or vertically without being damaged.



SPECIFICATIONS

INPUT VOLTAGE	24V DC Constant Voltage
POWER CONSUMPTION	3.4W per Ft.
LUMEN OUTPUT	190 Lm/ Ft.
LENS	Flat
CRI	88+
COLOR TEMPERATURE	24K/ 27K/ 30K/ 35K/ 40K/ 50K RD/ GN/ BL/ AM/ PK/ YW
DIMMING/ CONTROL	MLV, ELV, 0-10 and TRIAC
MAXIMUM RUN LENGTH	32 Ft.
CUTTABLE	Every 55.6mm (2.19 in)
STORAGE TEMPERATURE	-40°F (-40°C) to 176°F (80°C)
OPERATING TEMPERATURE	-4°F (-20°C) to 113°F (45°C)
BEAM ANGLE	160°
HUMIDITY	0-95% Non Condensing
IP RATING	IP67/ IP68
CERTIFICATIONS	UL Listed, UL-676 (IP68)
LUMEN MAINTENANCE	50,000 Hrs.

FEATURES

- High color consistency
- Multiple CCT options available
- Continuous run length up to 32 Ft.
- Bottom, Side and End Feed options
- UL-676 Pool Submersible (IP68 model)
- UL Listed (US and Canada)



MODEL	LENS	SURFACE	COLOR TEMP	VOLT	LENGTH	POWER FEED	FEED LENGTH	
LNT-65	F Flat	HB Horizontal Bend	24K 2400K	RD Red	24 24V DC	Please refer to page 4-5 for exact lengths with corresponding ordering codes.	BF Bottom Feed	HW3 3 Ft. Power Feed
			27K 2700K	GN Green			SFL Side Feed Left	HW10 10 Ft. Power Feed
		30K 3000K	BL Blue	SFR Side Feed Right			HW15 15 Ft. Power Feed	
		35K 3500K	AM Amber	EF End Feed			HW30 30 Ft. Power Feed	
		40K 4000K	PK Pink				HW50 50 Ft. Power Feed	
		50K 5000K	YW Yellow					

LNT-65

3.4W IP67/68 FLEXIBLE LED NEON SERIES

DIMENSIONS

LNT65-HB (HORIZONTAL BEND)

LNT65-VB (VERTICAL BEND)

POWER FEED CHOKER

~ 127mm (5 in)

All CORE Lighting IP67/IP68 Neons include a choker that sits roughly 5" from the end of the Neon.
*Warranty is void if removed.

COMPATIBLE ACCESSORIES

SELF LOCKING ALUMINUM PROFILE

LNT65-AC2
2" PROFILE

LNT65-AC39
39" PROFILE

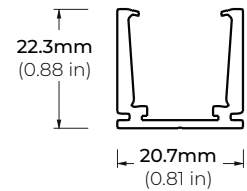

PLASTIC PROFILE

LNT65-PC39
39" PROFILE

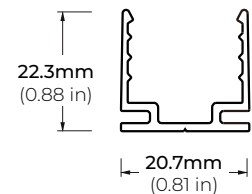

RECESSED PROFILE

LNT65-RS39
39" PROFILE

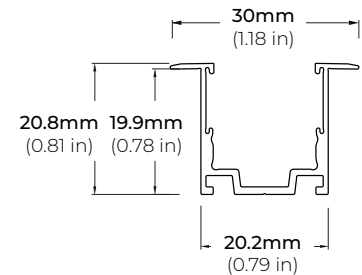
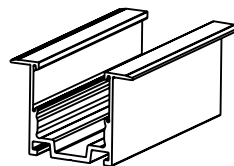

FLEXIBLE PROFILE

LNT65-SPX39-WH
39" PROFILE (WHITE)

LNT65-SPX39-BK
39" PROFILE (BLACK)

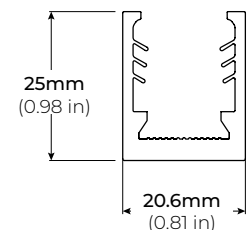
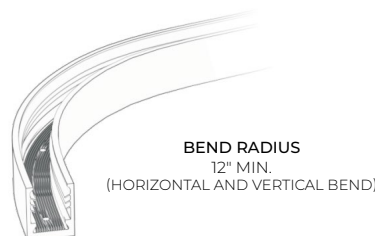

LNT-65

3.4W IP67/68 FLEXIBLE LED NEON SERIES

COMPATIBLE ACCESSORIES

RACEWAY PROFILE

LNT65-ARC39-SI
39" PROFILE (SILVER)

LNT65-ARC39-WH
39" PROFILE (WHITE)

LNT65-ARC39-BK
39" PROFILE (BLACK)

LNT65-ARC-EC
END CAPS

* Set of 2 (1 with Hole and 1 without Hole)

* Sold Separately

LNT65-ARC-JB
JOINER BRACKET

* Sold Separately

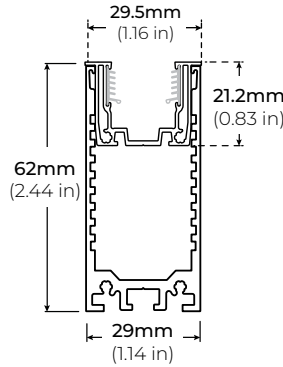

LNT65-ARC39

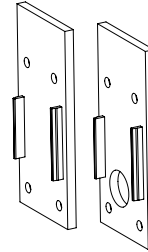

LNT65-ARC-EC

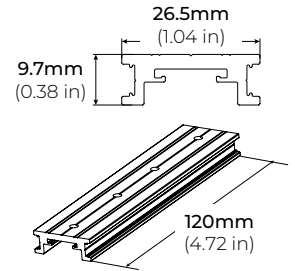

LNT65-ARC-JB

LNT65-BKT-ADJ
ADJUSTABLE BRACKET

* Only compatible with LNT65-AC2 and LNT65-AC39

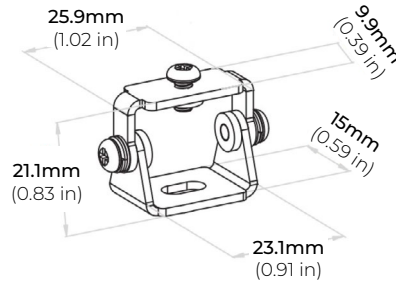

LNT-65

3.4W IP67/68 FLEXIBLE LED NEON SERIES

POWER FEED

BF
BOTTOM FEED

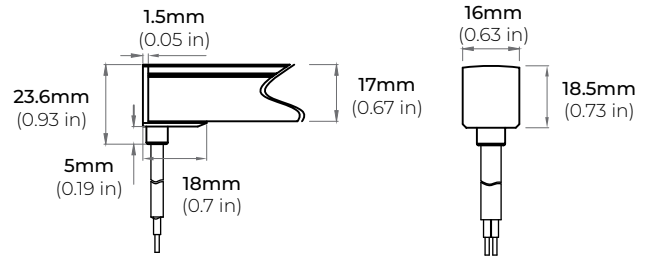

SFL
SIDE FEED LEFT

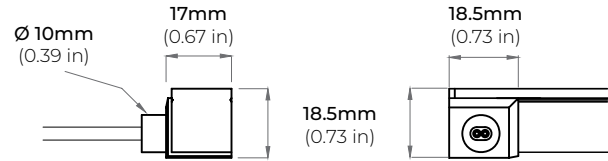
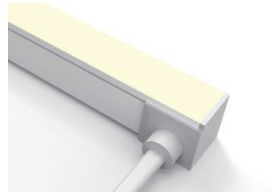

SFR
SIDE FEED RIGHT

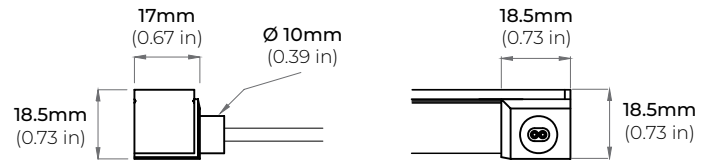

EF
END FEED

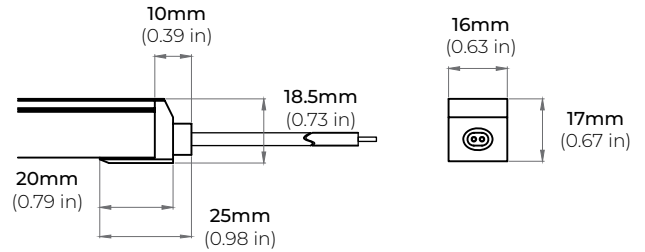

LNT65-EC
END CAP

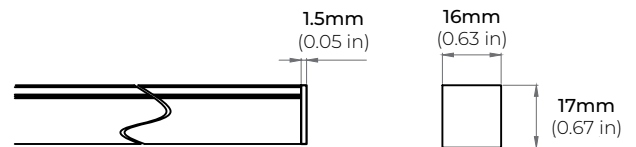
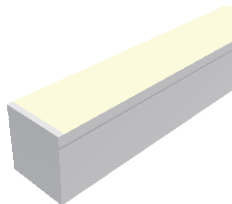

LNT-65

3.4W IP67/68 FLEXIBLE LED NEON SERIES

CUTTING LENGTH CODES

LNT-65 Series is cuttable every 2.19" (5.56CM). Please refer to the chart below to determine actual lengths once LED is cut versus actual lengths required or specified.

Total Length Calculation = Order Code Length + End Feed option Length

Example: 65.9" Total Length = Order Code 30 (65.7") + (0.20") Side Feed

* Optional lead wire lengths available: 3Ft., 10Ft., 16Ft., 32Ft., 50Ft.

POWER FEED OPTION	
END FEED	1.1"
BOTTOM FEED	0.20"
SIDE FEED	0.20"

CUTTING LENGTH INCREMENT TABLE

CODE	LENGTH (CM)	LENGTH (IN)
3	16.68	6.57
4	22.24	8.76
5	27.8	10.95
6	33.36	13.14
7	38.92	15.33
8	44.48	17.52
9	50.04	19.71
10	55.6	21.90
11	61.16	24.09
12	66.72	26.28
13	72.28	28.47
14	77.84	30.66
15	83.4	32.85
16	88.96	35.04
17	94.52	37.23
18	100.08	39.42
19	105.64	41.61
20	111.2	43.80
21	116.76	45.99
22	122.32	48.18
23	127.88	50.37
24	133.44	52.56
25	139	54.75
26	144.56	56.94
27	150.12	59.13
28	155.68	61.32
29	161.24	63.51
30	166.8	65.70
31	172.36	67.89
32	177.92	70.08
33	183.48	72.27
34	189.04	74.46
35	194.6	76.65
36	200.16	78.84
37	205.72	81.03
38	211.28	83.22
39	216.84	85.41
40	222.4	87.60
41	227.96	89.79
42	233.52	91.94

CODE	LENGTH (CM)	LENGTH (IN)
43	239.08	94.17
44	244.64	96.36
45	250.2	98.55
46	255.76	100.74
47	261.32	102.93
48	266.88	105.12
49	272.44	107.31
50	278	109.50
51	283.56	111.69
52	289.12	113.88
53	294.68	116.07
54	300.24	118.26
55	305.8	120.45
56	311.36	122.64
57	316.92	124.83
58	322.48	127.02
59	328.04	129.21
60	333.6	131.40
61	339.16	133.59
62	344.72	135.78
63	350.28	137.97
64	355.84	140.16
65	361.4	142.35
66	366.96	144.54
67	372.52	146.73
68	378.08	148.92
69	383.64	151.11
70	389.2	153.30
71	394.76	155.49
72	400.32	157.68
73	405.88	159.87
74	411.44	162.06
75	417	164.25
76	422.56	166.44
77	428.12	168.63
78	433.68	170.82
79	439.24	173.01
80	444.8	175.20
81	450.36	177.39
82	455.92	179.58

CODE	LENGTH (CM)	LENGTH (IN)
83	461.48	181.77
84	467.04	183.96
85	472.6	186.15
86	478.16	188.34
87	483.72	190.53
88	489.28	192.72
89	494.84	194.91
90	500.4	197.10
91	505.96	199.29
92	511.52	201.48
93	517.08	203.67
94	522.64	205.86
95	528.2	208.05
96	533.76	210.24
97	539.32	212.43
98	544.88	214.62
99	550.44	216.81
100	556	219.00
101	561.56	221.19
102	567.12	223.38
103	572.68	225.57
104	578.24	227.76
105	583.8	229.95
106	589.36	232.14
107	594.92	234.33
108	600.48	236.52
109	606.04	238.71
110	611.6	240.90
111	617.16	243.09
112	622.72	245.28
113	628.28	247.47
114	633.84	249.66
115	639.4	251.85
116	644.96	254.04
117	650.52	256.23
118	656.08	258.42
119	661.64	260.61
120	667.2	262.80
121	672.76	264.99
122	678.32	267.18

LNT-65

3.4W IP67/68 FLEXIBLE LED NEON SERIES

CUTTING LENGTH CODES (CONT.)

LNT-65 is cuttable every **2.19" (5.56CM)**. Please refer to the chart below to determine actual lengths once LED is cut versus actual lengths required or specified.

Total Length Calculation = Order Code Length + End Feed option Length

Example: 65.9" Total Length = Order Code 30 (65.7") + (0.20") Side Feed

* Optional lead wire lengths available: **3Ft., 10Ft., 16Ft., 32Ft., 50Ft.**

POWER FEED OPTION	
END FEED	1.1"
BOTTOM FEED	0.20"
SIDE FEED	0.20"

CUTTING LENGTH INCREMENT TABLE

CODE	LENGTH (CM)	LENGTH (IN)
123	683.88	269.37
124	689.44	271.56
125	695	273.75
126	700.56	275.94
127	706.12	278.13
128	711.68	280.32
129	717.24	282.51
130	722.8	284.70
131	728.36	286.89
132	733.92	289.08
133	739.48	291.27
134	745.04	293.46
135	750.6	295.65
136	756.16	297.84
137	761.72	300.03
138	767.28	302.22
139	772.84	304.41
140	778.4	306.60
141	783.96	308.79
142	789.52	310.98
143	795.08	313.17
144	800.64	315.36
145	806.2	317.55
146	811.76	319.74
147	817.32	321.93
148	822.88	324.12
149	828.44	326.31
150	834	328.50
151	839.56	330.69
152	845.12	332.88
153	850.68	335.07
154	856.24	337.26
155	861.8	339.45
156	867.36	341.64
157	872.92	343.83
158	878.48	346.02
159	884.04	348.21
160	889.6	350.40
161	895.16	352.59
162	900.72	354.78

CODE	LENGTH (CM)	LENGTH (IN)
163	906.28	356.97
164	911.84	359.16
165	917.4	361.35
166	922.96	363.54
167	928.52	365.73
168	934.08	367.92
169	939.64	370.11
170	945.2	372.30
171	950.76	374.49
172	956.32	376.68
173	961.88	378.87
174	967.44	381.06
175	973	383.25

LNT-65

3.4W IP67/68 FLEXIBLE LED NEON SERIES

COMPATIBLE TRANSFORMERS

PSDL SERIES TRIAC DIMMABLE

PSDL-30W-24V	CLASS 2	6.5" X 3.63" X 1.03"
PSDL-60W-24V	CLASS 2	7.4" X 3.63" X 1.03"
PSDL-96W-24V	CLASS 2	8.67" X 3.67 X 1.62"
PSDL-150W-24V		8.67" X 3.67" X 1.62"
PSDL-192W-24V	CLASS 2	10.25" X 4.06" X 1.82"
PSDL-200W-24V		10.25" X 4.06" X 1.82"
PSDL-288W-24V	CLASS 2	10.25" X 4.06" X 1.82"
PSDL-300W-24V		10.25" X 4.06" X 1.82"

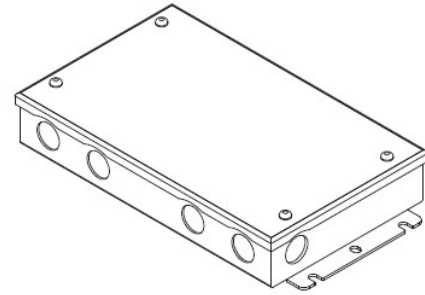

PSDH SERIES HIGH PERFORMANCE MAGNETIC LOW VOLTAGE (MLV)

PSDH-48W-24V	CLASS 2	11.25" X 3.37" X 3.25"
PSDH-96W-24V	CLASS 2	11.25" X 3.37" X 3.25"
PSDH-288W-24V	CLASS 2	14.25" X 8.43" X 4.43"

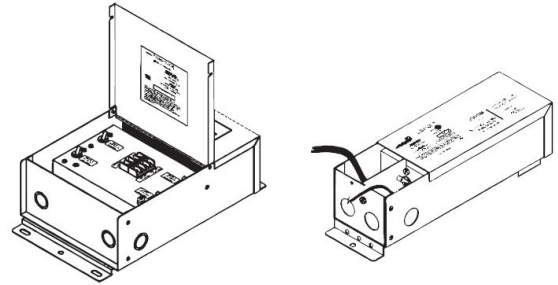

PSRX SERIES 4-IN-1 DIMMING DRIVER

PSRX-30W-24V	CLASS 2	6.5" X 3.72" X 1.57"
PSRX-60W-24V	CLASS 2	7.4" X 3.72" X 1.57"
PSRX-96W-24V	CLASS 2	8.66" X 3.72" X 1.57"
PSRX-150W-24V		10.24" X 4.13" X 1.77"
PSRX-192W-24V	CLASS 2	11" X 4" X 1.82"
PSRX-200W-24V		10.24" X 4.13" X 1.77"
PSRX-288W-24V	CLASS 2	11.85" X 4.25" X 1.82"
PSRX-300W-24V		10.94" X 4.33" X 1.77"

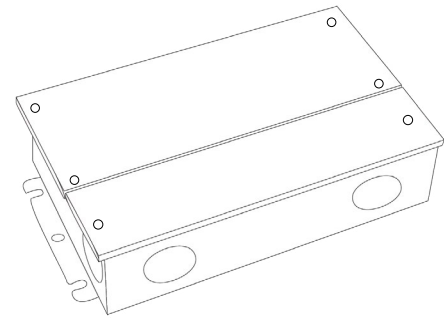

PSVT SERIES 0-10V DIMMING DRIVER

PSVT-60W-24V	CLASS 2	7.4" X 3.72" X 1.57"
PSVT-96W-24V	CLASS 2	8.66" X 3.72" X 1.57"
PSVT-200W-24V		10.24" X 4.13" X 1.77"
PSVT-288W-24V	CLASS 2	11.85" X 4.25" X 1.81"
PSVT-300W-24V		10.94" X 4.33" X 1.77"

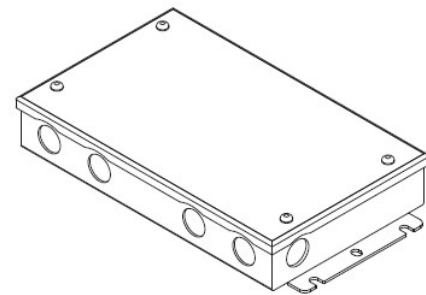

LNT-65

3.4W IP67/68 FLEXIBLE LED NEON SERIES

COMPATIBLE TRANSFORMERS

PSDE SERIES 0-10V DIMMING W/ JUNCTION BOX

PSDE-60W-24V-010-JB	CLASS 2	12.1" X 2.36" X 1.4"
PSDE-96W-24-010-JB	CLASS 2	12.1" X 2.36" X 1.4"

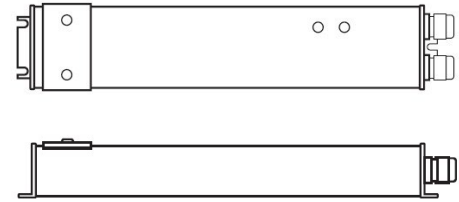

LUTRON 1% 3-WIRE DIMMING

L3DA4U1UKL-CV240	CLASS 2	4.89" X 4" X 2.62"
------------------	---------	--------------------

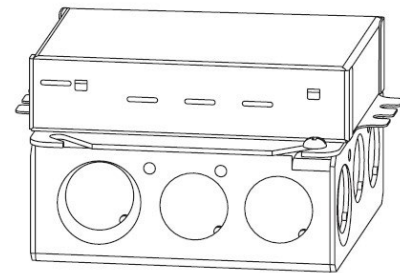

PSDE-96W-24V-ECO	CLASS 2	10.5" X 3.0" X 2.0"
------------------	---------	---------------------

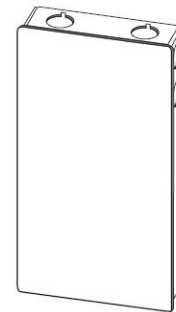

COMPATIBLE NON-DIMMING DRIVERS

PSHK SERIES NON-DIMMING CONSTANT VOLTAGE WITH JUNCTION BOX

PSHK-30W-24V	CLASS 2	6.5" X 3.6" X 1.02"
PSHK-60W-24V	CLASS 2	7.4" X 3.62" X 1.02"
PSHK-96W-24V	CLASS 2	8.66" X 3.66" X 1.61"
PSHK-150W-24V		10.24" X 4.06" X 1.81"
PSHK-200W-24V		10.24" X 4.06" X 1.81"
PSHK-288W-24V	CLASS 2	11.85" X 4.25" X 1.82"
PSHK-300W-24V		10.24" X 4.25" X 1.81"

