

# LWW-HO

## HIGH-OUTPUT LINEAR LED WALL WASHER

Project \_\_\_\_\_

Location \_\_\_\_\_

Quote/ Ref # \_\_\_\_\_

**LWW-HO** Linear Wall Washer series is a powerful LED flood light typically used for building facades, signs or any color-changing wall washing application. Multiple optical lens options provide a variety of lighting solutions. Available in narrow, medium, wide and elliptical optic options.

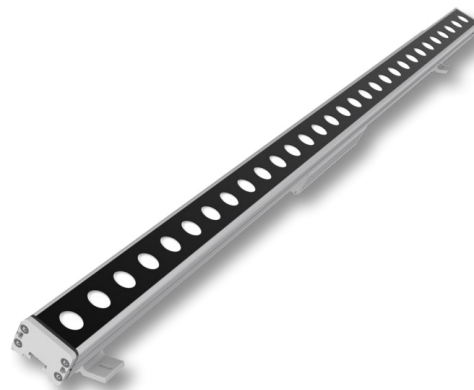

### SPECIFICATIONS

INPUT VOLTAGE	24V DC
POWER CONSUMPTION	9W per Ft.
LUMEN OUTPUT	110 Lm/ W.
CRI	90+
COLOR TEMPERATURE	22K/ 27K/ 30K/ 40K/ 50K/ 60K/ RD/ GN/ BL/ AM
BEAM ANGLE	15°/ 20°/ 35°/ 50°/ 10°x40°
DIMMING	TRIAC and 0-10V
MAX RUN	Linkable up to 12 ft.
OPERATING TEMPERATURE	-40°F TO 122°F (-40°C TO 50°C)
STORAGE TEMPERATURE	-40°F TO 176°F (-40°C TO 80°C)
IP RATING	IP65 wet location (outdoor)
LUMEN MAINTENANCE	50,000 Hrs.

### FEATURES

- 90+ CRI
- Linkable up to 12Ft.
- Proprietary Optical Technology
- Facade Wall Washing
- Graze Lighting
- Signage



MODEL	LENGTH	COLOR TEMP		OPTICS	OPTIONS	FINISH	VOLTAGE
LWW-HO	12 12" (9W)	22K	RD Red	15 15°	FMB Fixed Mounting Bracket	TG Titanium Grey	24V 24V
	20 20" (15W)	27K	GN Green	20 20°	STB Standard Tilting Bracket	BK Black	
		30K	BL Blue	35 35°			
	24 24" (18W)	40K	AM Amber	50 50°	ETB Extended Tilting Bracket	WH White	
		40 40" (30W)	50K				
	48 48" (36W)	60K					

# LWW-HO

## HIGH-OUTPUT LINEAR LED WALL WASHER

### DIMENSIONS

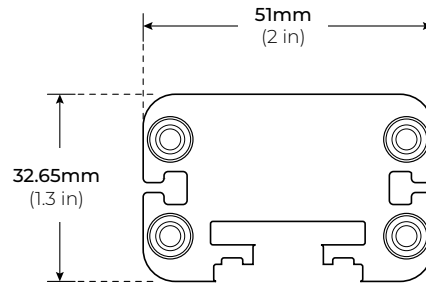

### OPTICS

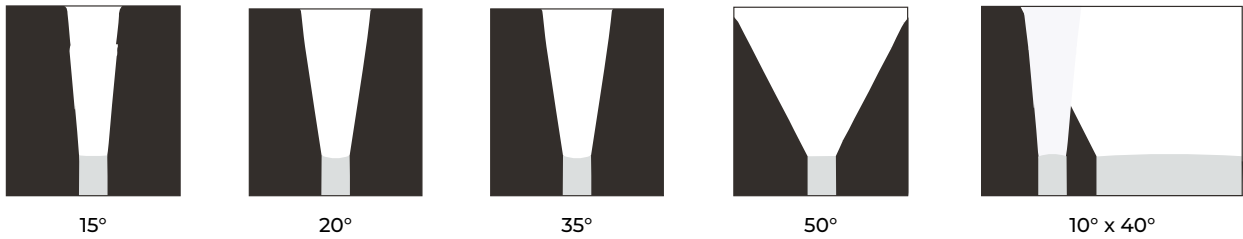

### MOUNTING ACCESSORIES

**LWW-FMB**  
FIXED MOUNTING BRACKET  
\*Sold Separately

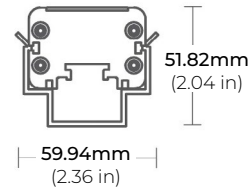

**LWW-STB**  
STANDARD TILTING BRACKET  
\*Included with every Fixture

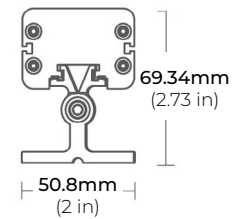

**LWW-ETB**  
EXTENDED TILTING BRACKET  
\*Sold Separately

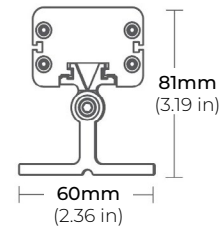

# LWW-HO

## HIGH-OUTPUT LINEAR LED WALL WASHER

### COMPATIBLE ACCESSORIES

LWW-EC  
END CAP  
\*Sold Separately

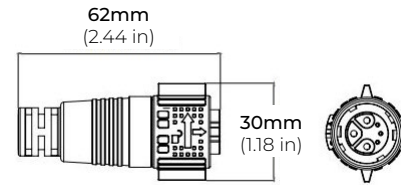

LWW-HO-12-ADLV  
LWW-HO-20-ADLV  
LWW-HO-24-ADLV  
LWW-HO-36-ADLV  
LWW-HO-40-ADLV  
LWW-HO-48-ADLV  
12", 20", 24", 36", 40", 48" ASYMMETRIC LOUVER  
\*Sold Separately

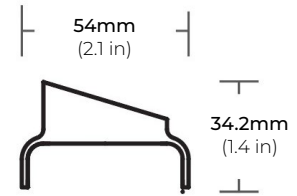
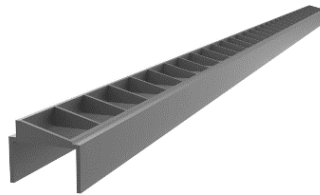

LWW-HO-12-SDLV  
LWW-HO-20-SDLV  
LWW-HO-24-SDLV  
LWW-HO-36-SDLV  
LWW-HO-40-SDLV  
LWW-HO-48-SDLV  
12", 20", 24", 36", 40", 48" SYMMETRIC LOUVER  
\*Sold Separately

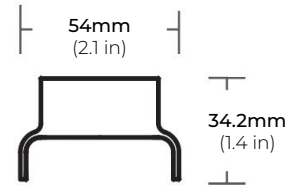
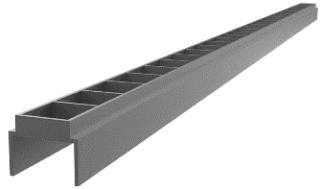

LWW-LNK-10  
LWW-LNK-36  
LWW-LNK-72  
10", 36", 72" LINK EXTENSION CABLE  
\*Sold Separately



LWW-HWC-72-BK  
72" HARDWIRE CABLE  
\*Sold Separately



# LWW-HO

## HIGH-OUTPUT LINEAR LED WALL WASHER

### PHOTOMETRICS

#### 4000K CRI80

BEAM ANGLE (50%) 15°  
FIELD ANGLE (10%) 25°

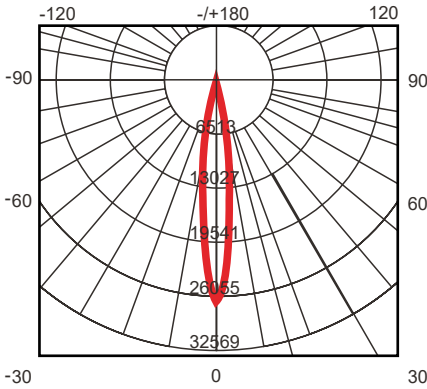

UNIT: CD

— C0-C180 — C90-C270

#### 4000K CRI80

BEAM ANGLE (50%) 20°  
FIELD ANGLE (10%) 40°

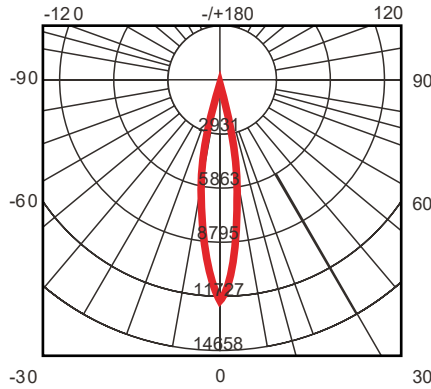

UNIT: CD

— C0-C180 — C90-C270

#### 4000K CRI80

BEAM ANGLE (50%) 35°  
FIELD ANGLE (10%) 55°

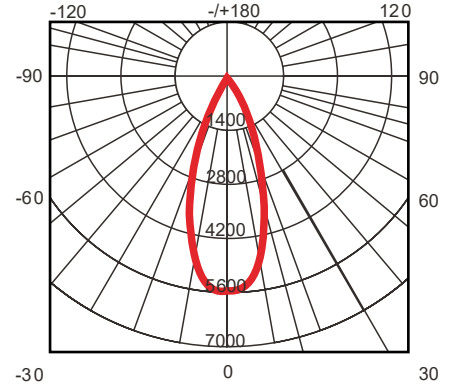

UNIT: CD

— C0-C180 — C90-C270

#### 4000K CRI80

BEAM ANGLE (50%) 50°  
FIELD ANGLE (10%) 80°

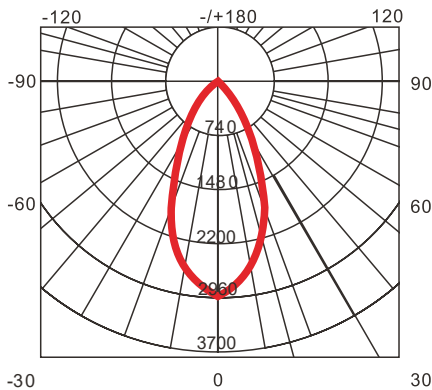

UNIT: CD

— C0-C180 — C90-C270

#### 4000K CRI80

BEAM ANGLE (50%) 10°x40°  
FIELD ANGLE (10%) 25°x60°

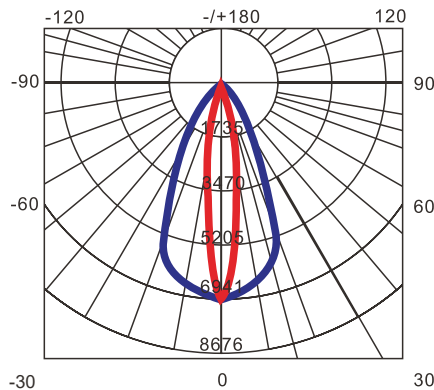

UNIT: CD

— C0-C180 — C90-C270

# LWW-HO

## HIGH-OUTPUT LINEAR LED WALL WASHER

### COMPATIBLE TRANSFORMERS

#### PSDL SERIES TRIAC DIMMABLE

PSDL-30W-24V	CLASS 2	6.5" X 3.63" X 1.03"
PSDL-60W-24V	CLASS 2	7.4" X 3.63" X 1.03"
PSDL-96W-24V	CLASS 2	8.67" X 3.67" X 1.62"
PSDL-150W-24V		8.67" X 3.67" X 1.62"
PSDL-192W-24V	CLASS 2	10.25" X 4.06" X 1.82"
PSDL-200W-24V		10.25" X 4.06" X 1.82"
PSDL-288W-24V	CLASS 2	10.25" X 4.06" X 1.82"
PSDL-300W-24V		10.25" X 4.06" X 1.82"

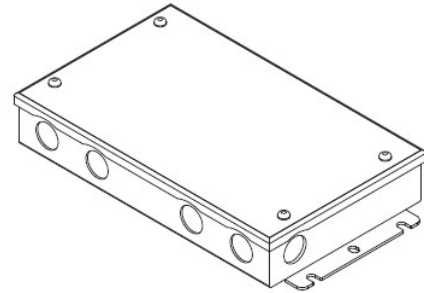

#### PSRX SERIES 4-IN-1 DIMMING DRIVER

PSRX-30W-24V	CLASS 2	6.5" X 3.72" X 1.57"
PSRX-60W-24V	CLASS 2	7.4" X 3.72" X 1.57"
PSRX-96W-24V	CLASS 2	8.66" X 3.72" X 1.57"
PSRX-150W-24V		10.24" X 4.13" X 1.77"
PSRX-192W-24V	CLASS 2	11" X 4" X 1.82"
PSRX-200W-24V		10.24" X 4.13" X 1.77"
PSRX-288W-24V	CLASS 2	11.85" X 4.25" X 1.82"
PSRX-300W-24V		10.94" X 4.33" X 1.77"

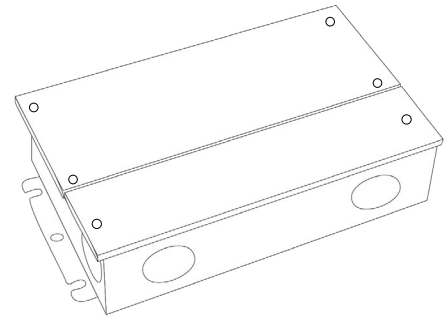

#### PSVT SERIES 0-10V DIMMING DRIVER

PSVT-60W-24V	CLASS 2	7.4" X 3.72" X 1.57"
PSVT-96W-24V	CLASS 2	8.66" X 3.72" X 1.57"
PSVT-200W-24V		10.24" X 4.13" X 1.77"
PSVT-288W-24V	CLASS 2	11.85" X 4.25" X 1.81"
PSVT-300W-24V		10.94" X 4.33" X 1.77"

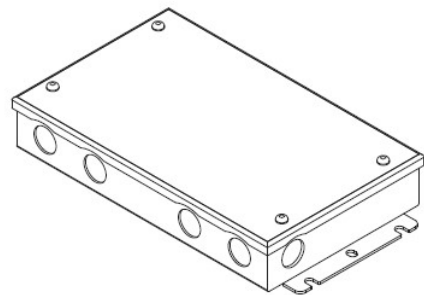

#### PSDE SERIES 0-10V DIMMING W/ JUNCTION BOX

PSDE-60W-24V-010-JB	CLASS 2	12.1" X 2.36" X 1.4"
PSDE-96W-24-010-JB	CLASS 2	12.1" X 2.36" X 1.4"

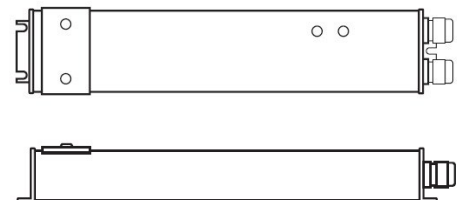

# LWW-HO

## HIGH-OUTPUT LINEAR LED WALL WASHER

### COMPATIBLE TRANSFORMERS

---

LUTRON 1%  
3-WIRE DIMMING

L3DA4U1UKL-CV240      CLASS 2    4.89" X 4" X 2.62"

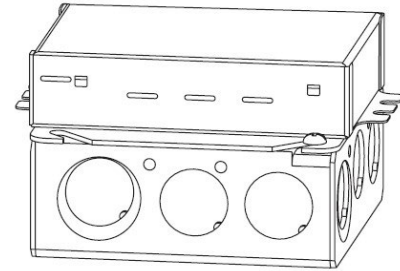

LUTRON 1%  
3-WIRE DIMMING

PSDE-96W-24V-ECO      CLASS 2    10.5" X 3.0" X 2.0"

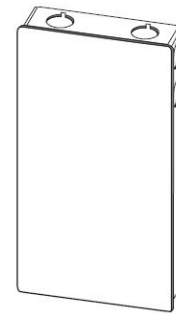

### COMPATIBLE NON-DIMMING DRIVERS

---

PSHK SERIES  
NON-DIMMING CONSTANT VOLTAGE WITH JUNCTION BOX

PSHK-30W-24V	CLASS 2	6.5" X 3.6" X 1.02"
PSHK-60W-24V	CLASS 2	7.4" X 3.62" X 1.02"
PSHK-96W-24V	CLASS 2	8.66" X 3.66" X 1.61"
PSHK-150W-24V		10.24" X 4.06" X 1.81"
PSHK-200W-24V		10.24" X 4.06" X 1.81"
PSHK-288W-24V	CLASS 2	11.85" X 4.25" X 1.82"
PSHK-300W-24V		10.24" X 4.25" X 1.81"

