

LNT-85

IP68 FLEXIBLE LED NEON SERIES

Project _____
Location _____
Quote/ Ref # _____

The **LNT-85** is a high performance flexible LED fixture that is useful in a wide variety of indoor or outdoor applications where a smooth surface or continuous line of light is desired. It is a flexible strip light that can bend around contours or tight curves horizontally or vertically without being damaged.



SPECIFICATIONS

INPUT VOLTAGE	24V DC Constant Voltage
POWER CONSUMPTION	5.1W
LUMEN OUTPUT	554 Lm./ Ft. (VB) 462 Lm./ Ft. (HB)
CRI	90+
COLOR TEMPERATURE	22K/ 27K/ 30K/ 35K/ 40K/ 50K
DIMMING/ CONTROL	MLV, ELV, 0-10, and TRIAC
MAXIMUM RUN LENGTH	23 Ft.
CUTTABLE	Every 55.6mm (2.19 in)
POWER FACTOR	≤1
STORAGE TEMPERATURE	-40°F (-40°C) to 140°F (60°C)
OPERATING TEMPERATURE	-40°F (-40°C) to 113°F (45°C)
BEAM ANGLE	120°
HUMIDITY	0-95% Non Condensing
IP RATING	IP68
CERTIFICATIONS	UL Listed
LUMEN MAINTENANCE	50,000 Hrs.

FEATURES

- High color consistency
- Smooth illumination
- Continuous run length up to 23 Ft.
- Dimmable with CORE dimmable drivers
- UV Resistant
- UL Listed (US and Canada)

LUMENS

CCT	VERTICAL BEND (Lm/ FT)	HORIZONTAL BEND (Lm/ FT)	CRI
2200K	456	380	90+
2700K	494	412	90+
3000K	494	412	90+
3500K	533	444	90+
4000K	533	444	90+
5000K	554	462	90+



MODEL	LIGHT SURFACE	COLOR TEMP	VOLTAGE	LENGTH	POWER FEED	FEED LENGTH
LNT-85	HB Horizontal Bend	22K 2700K	24 24V DC	Please refer to page 4 for exact lengths with corresponding ordering codes.	IP68EF End Feed	HW3 3 in. Power Feed
		VB Vertical Bend			27K 2700K	IP68SFL Side Feed Left
	30K 3000K				IP68SFR Side Feed Right	HW15 15 in. Power Feed
	35K 3500K				IP68BF Bottom Feed	HW30 30 in. Power Feed
	40K 4000K					HW50 50 in. Power Feed
	50K 5000K					

LNT-85

IP68 FLEXIBLE LED NEON SERIES

DIMENSIONS

LNT-85-VB

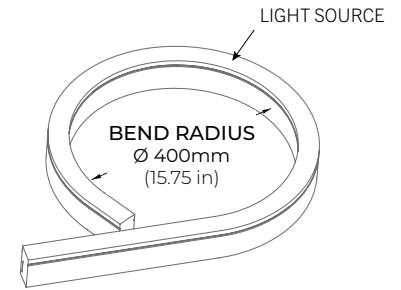
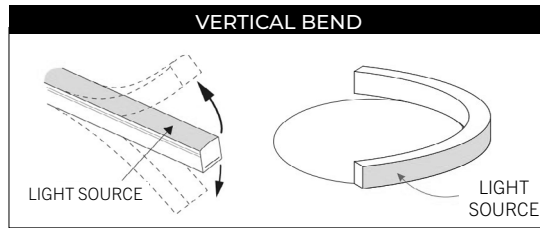
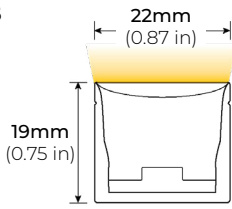

LNT-85-HB

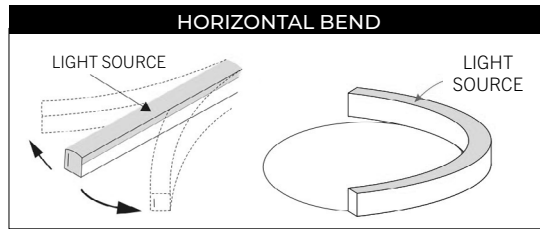
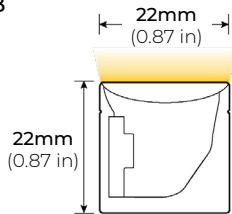

* LED strip only bends along vertical axis. Bending the LED strip horizontally (perpendicular) to the light surface risks damage to the LED strip. Do **NOT** bend more than the indicated bend radius (shown above). Doing so will damage the LED strip.

COMPATIBLE ACCESSORIES

ALUMINUM PROFILE

HORIZONTAL BEND

LNT85-HB-AC2-SI
2" PROFILE

LNT85-HB-AC39-SI
39" PROFILE

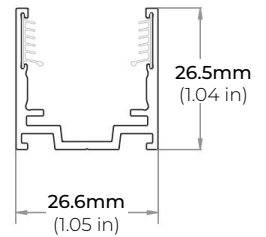
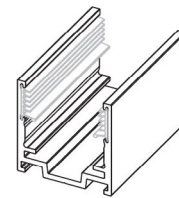

VERTICAL BEND

LNT85-VB-AC2-SI
2" PROFILE

LNT85-VB-AC39-SI
39" PROFILE

FLANGED ALUMINUM PROFILE

VERTICAL BEND

LNT85-VB-RS39-SI
39" PROFILE

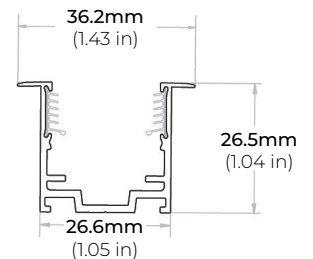
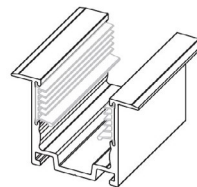

LNT-85

IP68 FLEXIBLE LED NEON SERIES

IP68 POWER FEED

IP68EF
END FEED

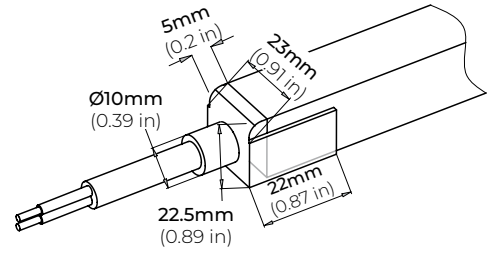

IP68SFL
SIDE FEED LEFT

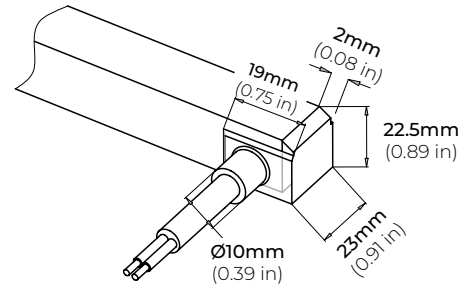

IP68SFR
SIDE FEED RIGHT

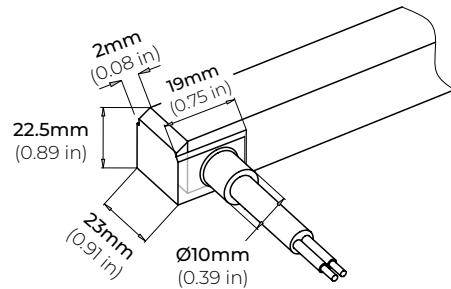

IP68BF
BOTTOM FEED

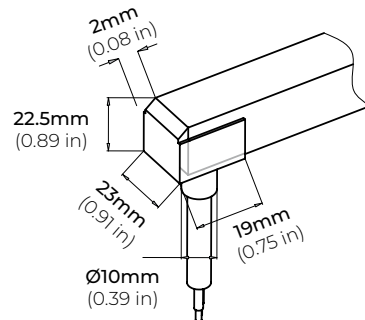

LNT-85

IP68 FLEXIBLE LED NEON SERIES

CUTTING LENGTH CODES

LNT-85 Series is cuttable every 2.19" (5.56CM). Please refer to the chart below to determine actual lengths once LED is cut versus actual lengths required or specified.

Total Length Calculation = Order Code Length + End Feed option Length
Example: 33.45" Total Length = Order Code 15 (32.85") + (0.60") End Feed

POWER FEED OPTION	LENGTH
END FEED	0.60"
SIDE FEED	0.20"
BOTTOM FEED	0.20"

CUTTING LENGTH INCREMENT TABLE

CODE	LENGTH (CM)	LENGTH (IN)
1	5.56	2.19
2	11.12	4.38
3	16.68	6.57
4	22.24	8.76
5	27.8	10.95
6	33.36	13.14
7	38.92	15.33
8	44.48	17.52
9	50.04	19.71
10	55.6	21.9
11	61.16	24.09
12	66.72	26.28
13	72.28	28.47
14	77.84	30.66
15	83.4	32.85
16	88.96	35.04
17	94.52	37.23
18	100.08	39.42
19	105.64	41.61
20	111.2	43.8
21	116.76	45.99
22	122.32	48.18
23	127.88	50.37
24	133.44	52.56
25	139	54.75
26	144.56	56.94
27	150.12	59.13
28	155.68	61.32
29	161.24	63.51
30	166.8	65.7
31	172.36	67.89
32	177.92	70.08
33	183.48	72.27
34	189.04	74.46
35	194.6	76.65
36	200.16	78.84
37	205.72	81.03
38	211.28	83.22
39	216.84	85.41
40	222.4	87.6
41	227.96	89.79
42	233.52	91.98

CODE	LENGTH (CM)	LENGTH (IN)
43	239.08	94.17
44	244.64	96.36
45	250.2	98.55
46	255.76	100.74
47	261.32	102.93
48	266.88	105.12
49	272.44	107.31
50	278	109.5
51	283.56	111.69
52	289.12	113.88
53	294.68	116.07
54	300.24	118.26
55	305.8	120.45
56	311.36	122.64
57	316.92	124.83
58	322.48	127.02
59	328.04	129.21
60	333.6	131.4
61	339.16	133.59
62	344.72	135.78
63	350.28	137.97
64	355.84	140.16
65	361.4	142.35
66	366.96	144.54
67	372.52	146.73
68	378.08	148.92
69	383.64	151.11
70	389.2	153.3
71	394.76	155.49
72	400.32	157.68
73	405.88	159.87
74	411.44	162.06
75	417	164.25
76	422.56	166.44
77	428.12	168.63
78	433.68	170.82
79	439.24	173.01
80	444.8	175.2
81	450.36	177.39
82	455.92	179.58
83	461.48	181.77
84	467.04	183.96

CODE	LENGTH (CM)	LENGTH (IN)
85	472.6	186.15
86	478.16	188.34
87	483.72	190.53
88	489.28	192.72
89	494.84	194.91
90	500.4	197.1
91	505.96	199.29
92	511.52	201.48
93	517.08	203.67
94	522.64	205.86
95	528.2	208.05
96	533.76	210.24
97	539.32	212.43
98	544.88	214.62
99	550.44	216.81
100	556	219
101	561.56	221.19
102	567.12	223.38
103	572.68	225.57
104	578.24	227.76
105	583.8	229.95
106	589.36	232.14
107	594.92	234.33
108	600.48	236.52
109	606.04	238.71
110	611.6	240.9
111	617.16	243.09
112	622.72	245.28
113	628.28	247.47
114	633.84	249.66
115	639.4	251.85
116	644.96	254.04
117	650.52	256.23
118	656.08	258.42
119	661.64	260.61
120	667.2	262.8
121	672.76	264.99
122	678.32	267.18
123	683.88	269.37
124	689.44	271.56
125	695	273.75
126	700.56	275.94

LNT-85

IP68 FLEXIBLE LED NEON SERIES

COMPATIBLE TRANSFORMERS

PSDL SERIES TRIAC DIMMABLE

PSDL-30W-24V	CLASS 2	6.5" X 3.63" X 1.58"
PSDL-60W-24V	CLASS 2	7.4" X 3.63" X 1.58"
PSDL-96W-24V	CLASS 2	8.67" X 3.67 X 1.62"
PSDL-150W-24V		10.25" X 4.06" X 1.82"
PSDL-192W-24V	CLASS 2	11" X 4" X 1.82"
PSDL-200W-24V		10.25" X 4.06" X 1.82"
PSDL-288W-24V	CLASS 2	11.85" X 4.25" X 1.82"
PSDL-300W-24V		10.25" X 4.06" X 1.82"

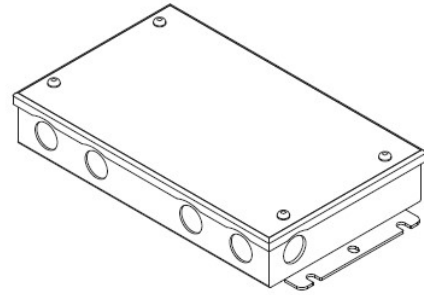

PSDH SERIES HIGH PERFORMANCE MAGNETIC LOW VOLTAGE (MLV)

PSDH-48W-24V	CLASS 2	11.25" X 3.38" X 3.38"
PSDH-96W-24V	CLASS 2	11.25" X 3.38" X 3.37"
PSDH-288W-24V	CLASS 2	14.25" X 8.43" X 4.43"

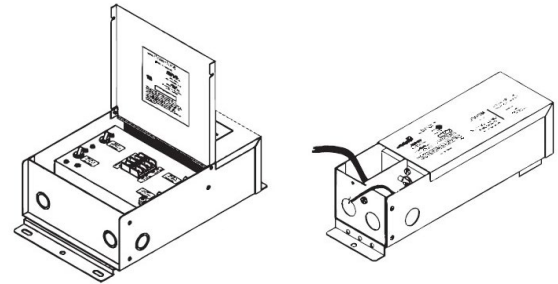

PSRX SERIES 4-IN-1 DIMMING DRIVER

PSRX-30W-24V	CLASS 2	6.5" X 3.72" X 1.57"
PSRX-60W-24V	CLASS 2	7.4" X 3.72" X 1.57"
PSRX-96W-24V	CLASS 2	8.66" X 3.72" X 1.57"
PSRX-150W-24V		10.24" X 4.13" X 1.77"
PSRX-192W-24V	CLASS 2	11" X 4" X 1.82"
PSRX-200W-24V		10.24" X 4.13" X 1.77"
PSRX-288W-24V	CLASS 2	11.85" X 4.25" X 1.82"
PSRX-300W-24V		10.94" X 4.33" X 1.77"

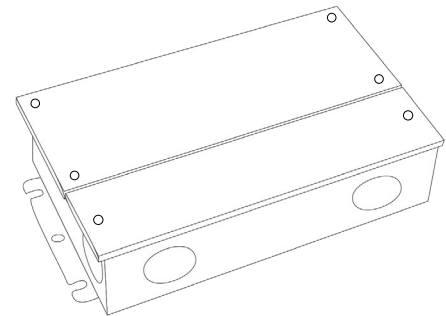

PSVT SERIES 0-10V DIMMING WITH JUNCTION BOX

PSVT-60W-24V-UNV-010	CLASS 2	7.4" X 3.72" X 1.57"
PSVT-96W-24V-UNV-010	CLASS 2	8.66" X 3.72" X 1.57"
PSVT-200W-24V-UNV-010		10.24" X 4.13" X 1.77"
PSVT-288W-24V-UNV-010	CLASS 2	11.85" X 4.25" X 1.81"
PSVT-300W-24V-UNV-010		10.94" X 4.33" X 1.77"

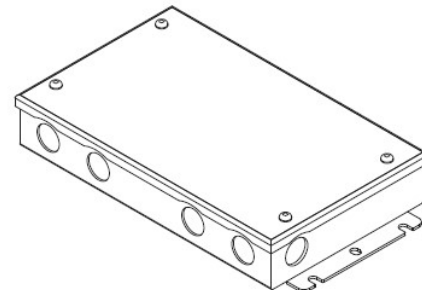

LNT-85

IP68 FLEXIBLE LED NEON SERIES

COMPATIBLE TRANSFORMERS

PSDE SERIES 0-10V DIMMING W/ JUNCTION BOX

PSDE-60W-24V-010-JB	CLASS 2	12.1" X 2.36" X 1.4"
PSDE-96W-24V-010-JB	CLASS 2	12.1" X 2.36" X 1.4"

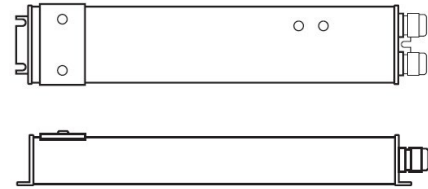

LUTRON 1% 3-WIRE DIMMING

L3DA4U1UKL-CV240	CLASS 2	4.89" X 4" X 2.62"
------------------	---------	--------------------

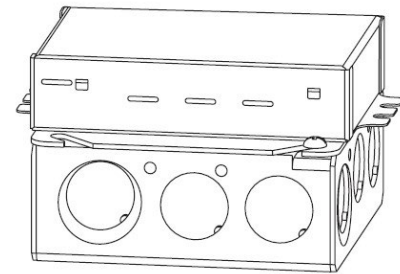

PSDE-96W-24V-ECO	CLASS 2	10.5" X 3.0" X 2.0"
------------------	---------	---------------------

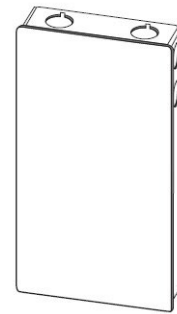

NON-DIMMING DRIVERS (COMPATABLE WITH ALL SYSTEMS)

PSHK SERIES NON-DIMMING CONSTANT VOLTAGE WITH JUNCTION BOX

PSHK-30W-24V	CLASS 2	6.5" X 3.6" X 1.02"
PSHK-60W-24V	CLASS 2	7.4" X 3.62" X 1.02"
PSHK-96W-24V	CLASS 2	8.66" X 3.66" X 1.61"
PSHK-150W-24V		10.24" X 4.06" X 1.81"
PSHK-200W-24V		10.24" X 4.06" X 1.81"
PSHK-288W-24V	CLASS 2	11.85" X 4.25" X 1.82"
PSHK-300W-24V		10.24" X 4.25" X 1.81"

