

LNT-65WD

4W WARM-DIM FLEXIBLE LED NEON SERIES

Project _____

Location _____

Quote/ Ref # _____

LNT-65WD is a warm-dim high-performance flexible LED strip designed as a neon replacement. Suitable for indoor and outdoor applications, the LNT-65WD automatically shifts color temperatures from 30K down to 18K as it is being dimmed. Available in horizontal and vertical bend options, It can easily follow the contours of your installation surface.



SPECIFICATIONS

INPUT VOLTAGE	24V DC Constant Voltage
POWER CONSUMPTION	4W per Ft.
LUMEN OUTPUT	183 Lm/ Ft. (30K)
CRI	88+
POWER FACTOR	≥ 1
COLOR TEMPERATURE	18K/30K
DIMMING	MLV, ELV, 0-10V and TRIAC
MAXIMUM RUN LENGTH	50 Ft.
CUTTABLE	Every 62.5mm (2.46 in)
STORAGE TEMPERATURE	-40°F (-40°C) to 140°F (60°C)
OPERATING TEMPERATURE	-40°F (-40°C) to 131°F (55°C)
BEAM ANGLE	112°
HUMIDITY	0-95% Non Condensing
IP RATING	IP67/ IP68
CERTIFICATIONS	UL Listed
LUMEN MAINTENANCE	50,000 Hrs.

FEATURES

- Auto warm-dim technology
- Smooth illumination
- Horizontal and Vertical bend options
- Bottom, Side and End Feed options
- 50 Ft. Maximum Run Length
- UL Listed (US and Canada)
- Dimmable with CORE dimmable drivers



MODEL	LENS	SURFACE	COLOR TEMP	VOLT	LENGTH	POWER FEED	FEED LENGTH
LNT-65WD	F Flat	HB Horizontal Bend VB Vertical Bend	18K/30K 1800K/3000K	24 24V DC	Please refer to page 4-5 for exact lengths with corresponding ordering codes.	BF Bottom Feed SFL Side Feed Left SFR Side Feed Right EF End Feed	HW3 3 Ft. Power Feed HW10 10 Ft. Power Feed HW15 15 Ft. Power Feed HW30 30 Ft. Power Feed HW50 50 Ft. Power Feed

LNT-65WD

4W WARM-DIM FLEXIBLE LED NEON SERIES

DIMENSIONS

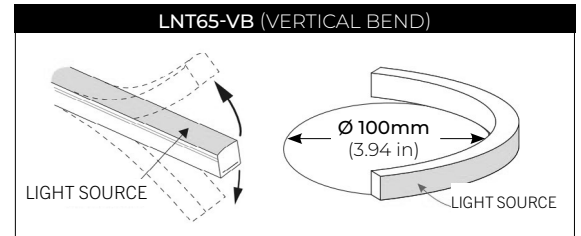
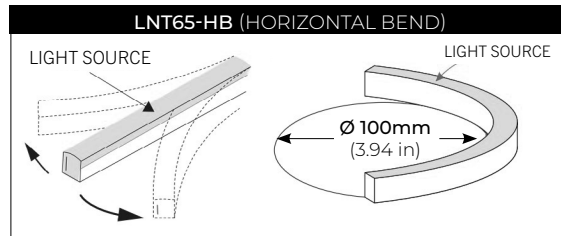
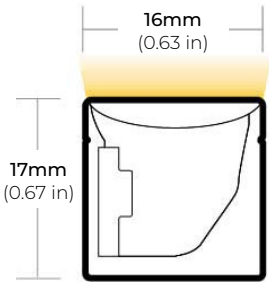

COMPATIBLE ACCESSORIES

SELF LOCKING ALUMINUM PROFILE

LNT65-AC2
2" PROFILE

LNT65-AC39
39" PROFILE

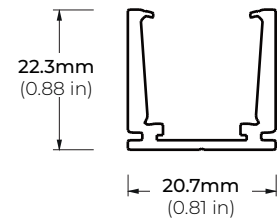

PLASTIC PROFILE

LNT65-PC39
39" PROFILE

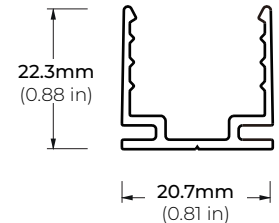
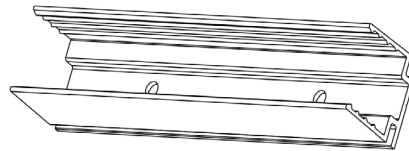

RECESSED PROFILE

LNT65-RS39
39" PROFILE

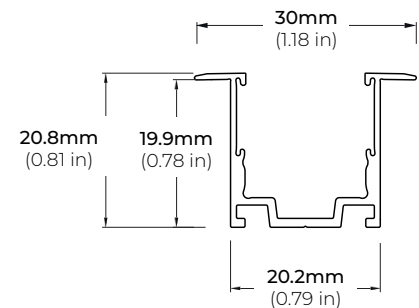
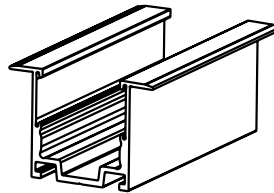

FLEXIBLE PROFILE

LNT65-SPX39-WH
39" PROFILE (WHITE)

LNT65-SPX39-BK
39" PROFILE (BLACK)

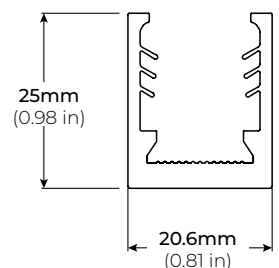
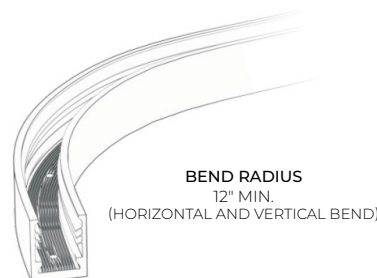

LNT-65WD

4W WARM-DIM FLEXIBLE LED NEON SERIES

COMPATIBLE ACCESSORIES

LNT65-BKT-ADJ
ADJUSTABLE BRACKET

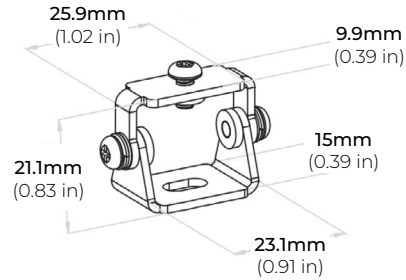

POWER FEED

BF
BOTTOM FEED

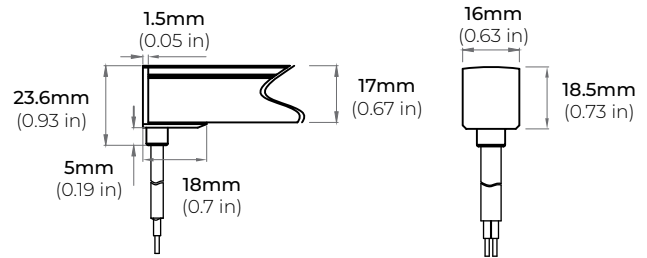

SFL
SIDE FEED LEFT

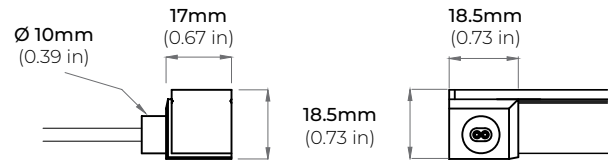
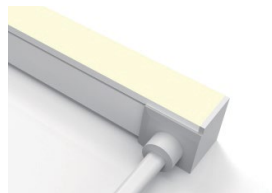

SFR
SIDE FEED RIGHT

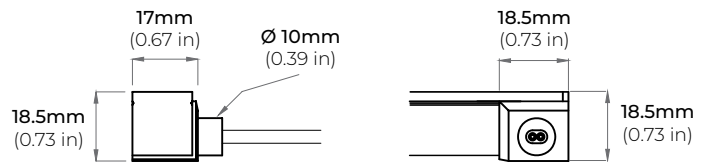

EF
END FEED

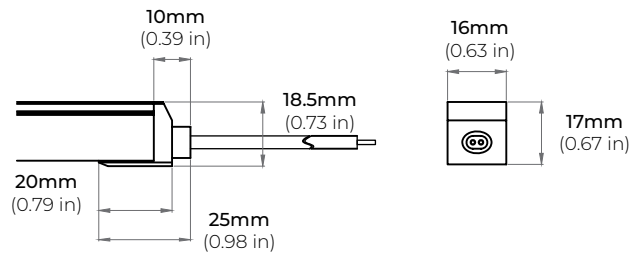

LNT65-EC
END CAP

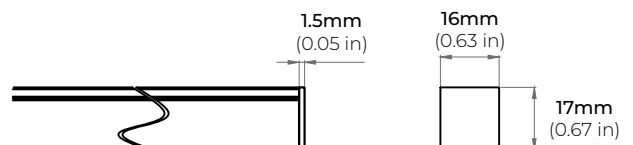
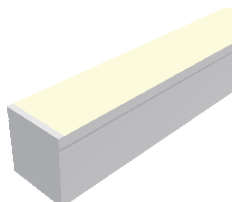

LNT-65WD

4W WARM-DIM FLEXIBLE LED NEON SERIES

CUTTING LENGTH CODES

LNT-65WD is cuttable every **2.46" (6.25CM)**. Please refer to the chart below to determine actual lengths once LED is cut versus actual lengths required or specified.

Total Length Calculation = Order Code Length + End Feed option Length
Example: 74" Total Length = Order Code 30 (73.80") + (0.20") Side Feed

* Optional lead wire lengths available: 3Ft., 10Ft., 16Ft., 32Ft., 50Ft.

POWER FEED OPTION	
END FEED	1.1"
BOTTOM FEED	0.20"
SIDE FEED	0.20"

CUTTING LENGTH INCREMENT TABLE

CODE	LENGTH (CM)	LENGTH (IN)
1	6.25	2.46
2	12.5	4.92
3	18.75	7.38
4	25	9.84
5	31.25	12.3
6	37.5	14.76
7	43.75	17.22
8	50	19.68
9	56.25	22.14
10	62.5	24.6
11	68.75	27.06
12	75	29.52
13	81.25	31.98
14	87.5	34.44
15	93.75	36.9
16	100	39.36
17	106.25	41.82
18	112.5	44.28
19	118.75	46.74
20	125	49.2
21	131.25	51.66
22	137.5	54.12
23	143.75	56.58
24	150	59.04
25	156.25	61.5
26	162.5	63.96
27	168.75	66.42
28	175	68.88
29	181.25	71.34
30	187.5	73.8
31	193.75	76.26
32	200	78.72
33	206.25	81.18
34	212.5	83.64
35	218.75	86.1
36	225	88.56
37	231.25	91.02
38	237.5	93.48
39	243.75	95.94
40	250	98.4
41	256.25	100.86

CODE	LENGTH (CM)	LENGTH (IN)
42	262.5	103.32
43	268.75	105.78
44	275	108.24
45	281.25	110.7
46	287.5	113.16
47	293.75	115.62
48	300	118.08
49	306.25	120.54
50	312.5	123
51	318.75	125.46
52	325	127.92
53	331.25	130.38
54	337.5	132.84
55	343.75	135.3
56	350	137.76
57	356.25	140.22
58	362.5	142.68
59	368.75	145.14
60	375	147.6
61	381.25	150.06
62	387.5	152.52
63	393.75	154.98
64	400	157.44
65	406.25	159.9
66	412.5	162.36
67	418.75	164.82
68	425	167.28
69	431.25	169.74
70	437.5	172.2
71	443.75	174.66
72	450	177.12
73	456.25	179.58
74	462.5	182.04
75	468.75	184.5
76	475	186.96
77	481.25	189.42
78	487.5	191.88
79	493.75	194.34
80	500	196.8
81	506.25	199.26
82	512.5	201.72

CODE	LENGTH (CM)	LENGTH (IN)
83	518.75	204.18
84	525	206.64
85	531.25	209.1
86	537.5	211.56
87	543.75	214.02
88	550	216.48
89	556.25	218.94
90	562.5	221.4
91	568.75	223.86
92	575	226.32
93	581.25	228.78
94	587.5	231.24
95	593.75	233.7
96	600	236.16
97	606.25	238.62
98	612.5	241.08
99	618.75	243.54
100	625	246
101	631.25	248.46
102	637.5	250.92
103	643.75	253.38
104	650	255.84
105	656.25	258.3
106	662.5	260.76
107	668.75	263.22
108	675	265.68
109	681.25	268.14
110	687.5	270.6
111	693.75	273.06
112	700	275.52
113	706.25	277.98
114	712.5	280.44
115	718.75	282.9
116	725	285.36
117	731.25	287.82
118	737.5	290.28
119	743.75	292.74
120	750	295.2
121	756.25	297.66
122	762.5	300.12
123	768.75	302.58

LNT-65WD

4W WARM-DIM FLEXIBLE LED NEON SERIES

CUTTING LENGTH CODES (CONT.)

LNT-65WD is cuttable every **2.46" (6.25CM)**. Please refer to the chart below to determine actual lengths once LED is cut versus actual lengths required or specified.

Total Length Calculation = Order Code Length + End Feed option Length

Example: 74" Total Length = Order Code 30 (73.80") + (0.20") Side Feed

* Optional lead wire lengths available: 3Ft., 10Ft., 16Ft., 32Ft., 50Ft.

POWER FEED OPTION	
END FEED	1.1"
BOTTOM FEED	0.20"
SIDE FEED	0.20"

CUTTING LENGTH INCREMENT TABLE

CODE	LENGTH (CM)	LENGTH (IN)
124	775	305.04
125	781.25	307.5
126	787.5	309.96
127	793.75	312.42
128	800	314.88
129	806.25	317.34
130	812.5	319.8
131	818.75	322.26
132	825	324.72
133	831.25	327.18
134	837.5	329.64
135	843.75	332.1
136	850	334.56
137	856.25	337.02
138	862.5	339.48
139	868.75	341.94
140	875	344.4
141	881.25	346.86
142	887.5	349.32
143	893.75	351.78
144	900	354.24
145	906.25	356.7
146	912.5	359.16
147	918.75	361.62
148	925	364.08
149	931.25	366.54
150	937.5	369
151	943.75	371.46
152	950	373.92
153	956.25	376.38
154	962.5	378.84
155	968.75	381.3
156	975	383.76
157	981.25	386.22
158	987.5	388.68
159	993.75	391.14
160	1000	393.6
161	1006.25	396.06
162	1012.5	398.52
163	1018.75	400.98
164	1025	403.44

CODE	LENGTH (CM)	LENGTH (IN)
165	1031.25	405.9
166	1037.5	408.36
167	1043.75	410.82
168	1050	413.28
169	1056.25	415.74
170	1062.5	418.2
171	1068.75	420.66
172	1075	423.12
173	1081.25	425.58
174	1087.5	428.04
175	1093.75	430.5
176	1100	432.96
177	1106.25	435.42
178	1112.5	437.88
179	1118.75	440.34
180	1125	442.8
181	1131.25	445.26
182	1137.5	447.72
183	1143.75	450.18
184	1150	452.64
185	1156.25	455.1
186	1162.5	457.56
187	1168.75	460.02
188	1175	462.48
189	1181.25	464.94
190	1187.5	467.4
191	1193.75	469.86
192	1200	472.32
193	1206.25	474.78
194	1212.5	477.24
195	1218.75	479.7
196	1225	482.16
197	1231.25	484.62
198	1237.5	487.08
199	1243.75	489.54
200	1250	492
201	1256.25	494.46
202	1262.5	496.92
203	1268.75	499.38
204	1275	501.84
205	1281.25	504.3

CODE	LENGTH (CM)	LENGTH (IN)
206	1287.5	506.76
207	1293.75	509.22
208	1300	511.68
209	1306.25	514.14
210	1312.5	516.6
211	1318.75	519.06
212	1325	521.52
213	1331.25	523.98
214	1337.5	526.44
215	1343.75	528.9
216	1350	531.36
217	1356.25	533.82
218	1362.5	536.28
219	1368.75	538.74
220	1375	541.2
221	1381.25	543.66
222	1387.5	546.12
223	1393.75	548.58
224	1400	551.04
225	1406.25	553.5
226	1412.5	555.96
227	1418.75	558.42
228	1425	560.88
229	1431.25	563.34
230	1437.5	565.8
231	1443.75	568.26
232	1450	570.72
233	1456.25	573.18
234	1462.5	575.64
235	1468.75	578.1
236	1475	580.56
237	1481.25	583.02
238	1487.5	585.48
239	1493.75	587.94
240	1500	590.4
241	1506.25	592.86
242	1512.5	595.32
243	1518.75	597.78
244	1525	600.24

LNT-65WD

4W WARM-DIM FLEXIBLE LED NEON SERIES

COMPATIBLE TRANSFORMERS

PSDL SERIES TRIAC DIMMABLE

PSDL-30W-24V	CLASS 2	6.5" X 3.63" X 1.03"
PSDL-60W-24V	CLASS 2	7.4" X 3.63" X 1.03"
PSDL-96W-24V	CLASS 2	8.67" X 3.67 X 1.62"
PSDL-150W-24V		8.67" X 3.67" X 1.62"
PSDL-192W-24V	CLASS 2	10.25" X 4.06" X 1.82"
PSDL-200W-24V		10.25" X 4.06" X 1.82"
PSDL-288W-24V	CLASS 2	10.25" X 4.06" X 1.82"
PSDL-300W-24V		10.25" X 4.06" X 1.82"

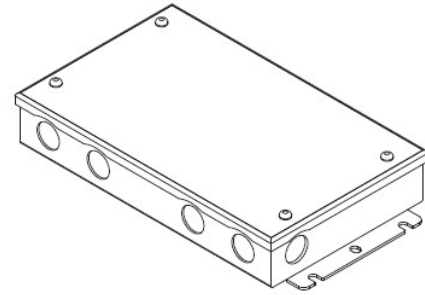

PSDH SERIES HIGH PERFORMANCE MAGNETIC LOW VOLTAGE (MLV)

PSDH-48W-24V	CLASS 2	11.25" X 3.37" X 3.25"
PSDH-96W-24V	CLASS 2	11.25" X 3.37" X 3.25"
PSDH-288W-24V	CLASS 2	14.25" X 8.43" X 4.43"

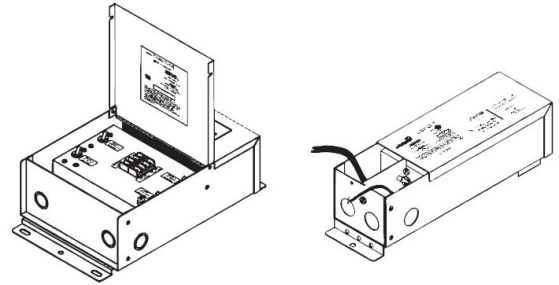

PSRX SERIES 4-IN-1 DIMMING DRIVER

PSRX-30W-24V	CLASS 2	6.5" X 3.72" X 1.57"
PSRX-60W-24V	CLASS 2	7.4" X 3.72" X 1.57"
PSRX-96W-24V	CLASS 2	8.66" X 3.72" X 1.57"
PSRX-150W-24V		10.24" X 4.13" X 1.77"
PSRX-192W-24V	CLASS 2	11" X 4" X 1.82"
PSRX-200W-24V		10.24" X 4.13" X 1.77"
PSRX-288W-24V	CLASS 2	11.85" X 4.25" X 1.82"
PSRX-300W-24V		10.94" X 4.33" X 1.77"

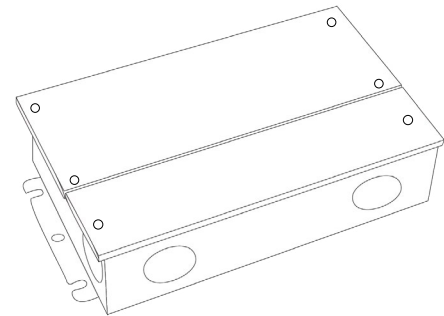

PSVT SERIES 0-10V DIMMING DRIVER

PSVT-60W-24V	CLASS 2	7.4" X 3.72" X 1.57"
PSVT-96W-24V	CLASS 2	8.66" X 3.72" X 1.57"
PSVT-200W-24V		10.24" X 4.13" X 1.77"
PSVT-288W-24V	CLASS 2	11.85" X 4.25" X 1.81"
PSVT-300W-24V		10.94" X 4.33" X 1.77"

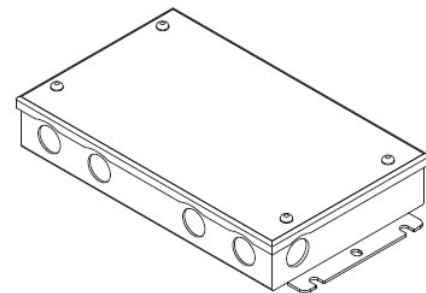

LNT-65WD

4.5W IP67/ IP68 COLOR CHANGING + WHITE NEON SERIES

COMPATIBLE TRANSFORMERS

PSDE SERIES

0-10V DIMMING W/ JUNCTION BOX

PSDE-60W-24V-010-JB	CLASS 2	12.1" X 2.36" X 1.4"
PSDE-96W-24V-010-JB	CLASS 2	12.1" X 2.36" X 1.4"

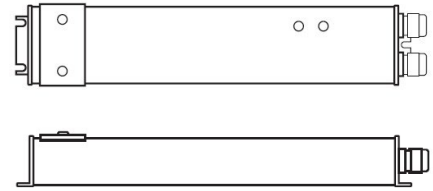

LUTRON 1%

3-WIRE DIMMING

L3DA4U1UKL-CV240	CLASS 2	4.89" X 4" X 2.62"
------------------	---------	--------------------

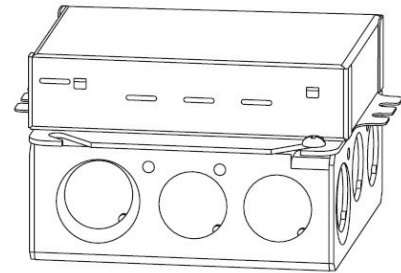

LUTRON 1%

3-WIRE DIMMING

PSDE-96W-24V-ECO	CLASS 2	10.5" X 3.0" X 2.0"
------------------	---------	---------------------

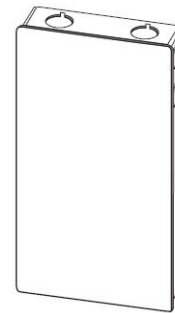

COMPATIBLE NON-DIMMING DRIVERS

PSHK SERIES

NON-DIMMING CONSTANT VOLTAGE WITH JUNCTION BOX

PSHK-30W-24V	CLASS 2	6.5" X 3.6" X 1.02"
PSHK-60W-24V	CLASS 2	7.4" X 3.62" X 1.02"
PSHK-96W-24V	CLASS 2	8.66" X 3.66" X 1.61"
PSHK-150W-24V		10.24" X 4.06" X 1.81"
PSHK-200W-24V		10.24" X 4.06" X 1.81"
PSHK-288W-24V	CLASS 2	11.85" X 4.25" X 1.82"
PSHK-300W-24V		10.24" X 4.25" X 1.81"

