

LNE-50 DUAL BEND

4.75W IP67 FLEXIBLE LED NEON SERIES

Project _____

Location _____

Quote/ Ref # _____

The **LNE-50 Dual Bend** is a flexible LED fixture that offers both high performance and affordability. Specifically designed as a neon replacement, this fixture can bend **horizontally and vertically** around contours or tight curves without risk of damage. Able to provide up to 32 feet of continuous line of light, it's an ideal choice for indoor or outdoor applications where a sleek, smooth surface is desired.

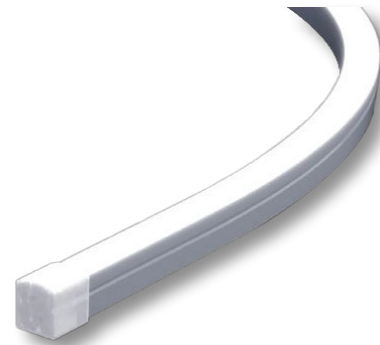

SPECIFICATIONS

POWER CONSUMPTION	4.75W per Ft.
LUMEN OUTPUT	253 Lumens per Ft. (30K)
CRI	88+
COLOR TEMPERATURE	24K/ 27K/ 30K/ 35K/ 40K/ 50K
DIMMING/ CONTROL	MLV, ELV, 0-10V, and TRIAC
MAXIMUM RUN LENGTH	32 Ft.
CUTTABLE	Every 2.46 in. (62.5mm)
OPERATING VOLTAGE	24V DC
STORAGE TEMPERATURE	-4°F (-20°C) to 158°F (70°C)
OPERATING TEMPERATURE	-4°F (-20°C) to 140°F (60°C)
BEAM ANGLE	120°
IP RATING	IP67
CERTIFICATIONS	UL Listed
LUMEN MAINTENANCE	50,000 Hrs.

FEATURES

- High color consistency and smooth illumination
- UV Resistant
- Continuous run length up to 32 Ft.
- Cuttable every 2.46 in. (62.5mm)
- Bottom, Side and End Feed options
- UL Listed (US and Canada)

LUMENS

CCT	LM/W	LM/ FT.
2400K	46	216
2700K	52	246
3000K	54	253
3500K	56	262
4000K	56	266
5000K	57	267



MODEL	COLOR TEMP	VOLTAGE	LENGTH	POWER FEED	FEED LENGTH
LNE50-DB	24K 2400K	24 24V DC	Please refer to pages 4 for exact lengths with corresponding ordering codes.	BF Bottom Feed	HW3 3 Ft. Power Feed
	27K 2700K			SFL Side Feed Left	HW10 10 Ft. Power Feed
	30K 3000K			SFR Side Feed Right	HW15 15 Ft. Power Feed
	35K 3500K			EF End Feed	HW30 30 Ft. Power Feed
	40K 4000K			HW50 50 Ft. Power Feed	

LNE-50 DUAL BEND

4.75W IP67 FLEXIBLE LED NEON SERIES

DIMENSIONS

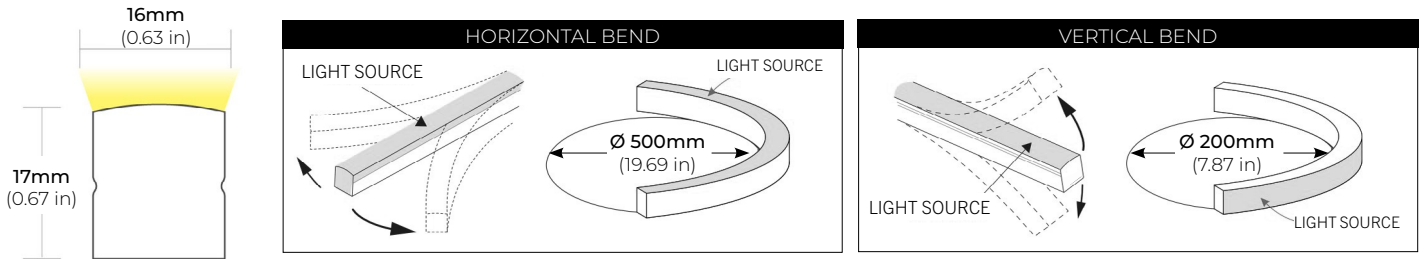

LIGHT DISTRIBUTION

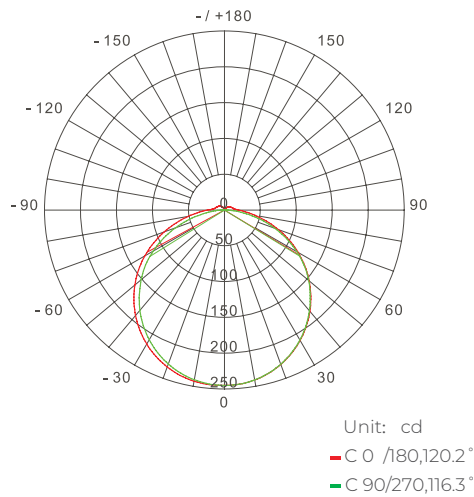

AVERAGE BEAM ANGLE (50%): 118.3°
* TESTED AT 4000K

COMPATIBLE ACCESSORIES

SELF LOCKING ALUMINUM PROFILE

LNE-AC2
2" PROFILE

LNE-AC39
39" PROFILE



LNE-50 DUAL BEND

4.75W IP67 FLEXIBLE LED NEON SERIES

POWER FEEDS

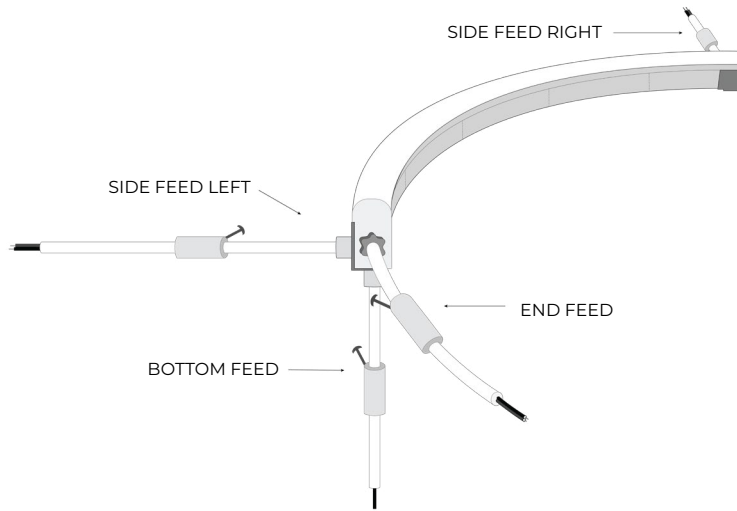

BF
BOTTOM FEED

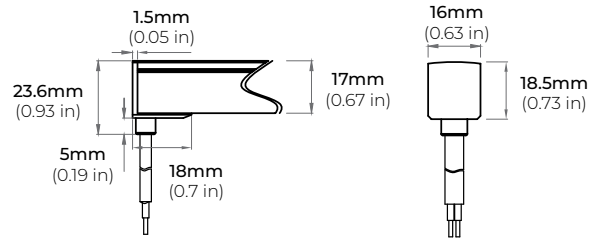

SFL
SIDE LEFT FEED

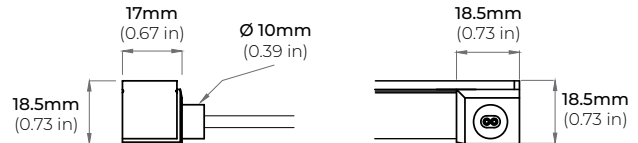

SFR
SIDE RIGHT FEED

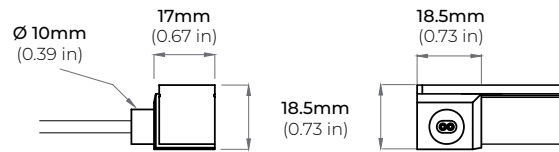

EF
END FEED

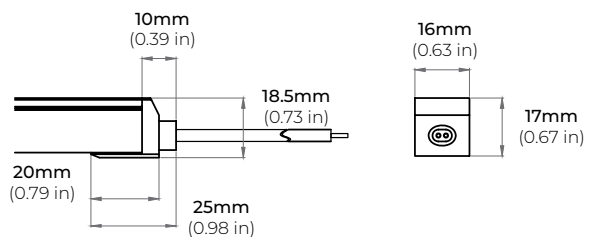

LNE-50 DUAL BEND

4.75W IP67 FLEXIBLE LED NEON SERIES

CUTTING LENGTH CODES

LNE-50 Dual Bend is cuttable every 2.46" (6.25CM). Please refer to the chart below to determine actual lengths once LED is cut versus actual lengths required or specified.

Total Length Calculation = Order Code Length + End Feed option Length

Example: 38.43" Total Length = Order Code 15 (36.9") + (1.53") End Feed

POWER FEED OPTION	LENGTH
END FEED	1.53 INCHES

CUTTING LENGTH INCREMENT TABLE

CODE	LENGTH (CM)	LENGTH (IN)
1	6.25	2.46
2	12.5	4.92
3	18.75	7.38
4	25	9.84
5	31.25	12.3
6	37.5	14.76
7	43.75	17.22
8	50	19.68
9	56.25	22.14
10	62.5	24.6
11	68.75	27.06
12	75	29.52
13	81.25	31.98
14	87.5	34.44
15	93.75	36.9
16	100	39.36
17	106.25	41.82
18	112.5	44.28
19	118.75	46.74
20	125	49.2
21	131.25	51.66
22	137.5	54.12
23	143.75	56.58
24	150	59.04
25	156.25	61.5
26	162.5	63.96
27	168.75	66.42
28	175	68.88
29	181.25	71.34
30	187.5	73.8
31	193.75	76.26
32	200	78.72
33	206.25	81.18
34	212.5	83.64
35	218.75	86.1
36	225	88.56
37	231.25	91.02
38	237.5	93.48
39	243.75	95.94
40	250	98.4

CODE	LENGTH (CM)	LENGTH (IN)
41	256.25	100.86
42	262.5	103.32
43	268.75	105.78
44	275	108.24
45	281.25	110.7
46	287.5	113.16
47	293.75	115.62
48	300	118.08
49	306.25	120.54
50	312.5	123
51	318.75	125.46
52	325	127.92
53	331.25	130.38
54	337.5	132.84
55	343.75	135.3
56	350	137.76
57	356.25	140.22
58	362.5	142.68
59	368.75	145.14
60	375	147.6
61	381.25	150.06
62	387.5	152.52
63	393.75	154.98
64	400	157.44
65	406.25	159.9
66	412.5	162.36
67	418.75	164.82
68	425	167.28
69	431.25	169.74
70	437.5	172.2
71	443.75	174.66
72	450	177.12
73	456.25	179.58
74	462.5	182.04
75	468.75	184.5
76	475	186.96
77	481.25	189.42
78	487.5	191.88
79	493.75	194.34
80	500	196.8

CODE	LENGTH (CM)	LENGTH (IN)
81	506.25	199.26
82	512.5	201.72
83	518.75	204.18
84	525	206.64
85	531.25	209.1
86	537.5	211.56
87	543.75	214.02
88	550	216.48
89	556.25	218.94
90	562.5	221.4
91	568.75	223.86
92	575	226.32
93	581.25	228.78
94	587.5	231.24
95	593.75	233.7
96	600	236.16
97	606.25	238.62
98	612.5	241.08
99	618.75	243.54
100	625	246
101	631.25	248.46
102	637.5	250.92
103	643.75	253.38
104	650	255.84
105	656.25	258.3
106	662.5	260.76
107	668.75	263.22
108	675	265.68
109	681.25	268.14
110	687.5	270.6
111	693.75	273.06
112	700	275.52
113	706.25	277.98
114	712.5	280.44
115	718.75	282.9
116	725	285.36
117	731.25	287.82
118	737.5	290.28
119	743.75	292.74
120	750	295.2

LNE-50 DUAL BEND

4.75W IP67 FLEXIBLE LED NEON SERIES

CUTTING LENGTH CODES

LNE-50 Dual Bend is cuttable every **2.46" (6.25CM)**. Please refer to the chart below to determine actual lengths once LED is cut versus actual lengths required or specified.

Total Length Calculation = Order Code Length + End Feed option Length

Example: 38.43" Total Length = Order Code 15 (36.9") + (1.53") End Feed

POWER FEED OPTION	LENGTH
END FEED	1.53 INCHES

CUTTING LENGTH INCREMENT TABLE

CODE	LENGTH (CM)	LENGTH (IN)
121	756.25	297.66
122	762.5	300.12
123	768.75	302.58
124	775	305.04
125	781.25	307.5
126	787.5	309.96
127	793.75	312.42
128	800	314.88
129	806.25	317.34
130	812.5	319.8
131	818.75	322.26
132	825	324.72
133	831.25	327.18
134	837.5	329.64
135	843.75	332.1
136	850	334.56
137	856.25	337.02
138	862.5	339.48
139	868.75	341.94
140	875	344.4
141	881.25	346.86
142	887.5	349.32
143	893.75	351.78
144	900	354.24
145	906.25	356.7
146	912.5	359.16
147	918.75	361.62
148	925	364.08
149	931.25	366.54
150	937.5	369
151	943.75	371.46
152	950	373.92
153	956.25	376.38
154	962.5	378.84
155	968.75	381.3
156	975	383.76

LNE-50 DUAL BEND

4.75W IP67 FLEXIBLE LED NEON SERIES

COMPATIBLE TRANSFORMERS

PSDL SERIES TRIAC DIMMABLE

PSDL-30W-24V	CLASS 2	6.5" X 3.63" X 1.03"
PSDL-60W-24V	CLASS 2	7.4" X 3.63" X 1.03"
PSDL-96W-24V	CLASS 2	8.67" X 3.67 X 1.62"
PSDL-150W-24V		8.67" X 3.67" X 1.62"
PSDL-192W-24V	CLASS 2	10.25" X 4.06" X 1.82"
PSDL-200W-24V		10.25" X 4.06" X 1.82"
PSDL-288W-24V	CLASS 2	10.25" X 4.06" X 1.82"
PSDL-300W-24V		10.25" X 4.06" X 1.82"

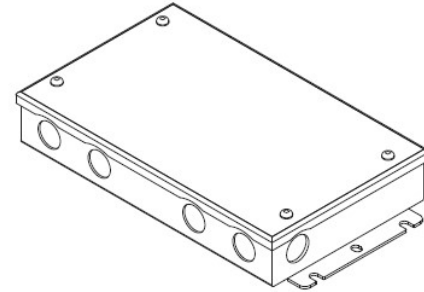

PSDH SERIES HIGH PERFORMANCE MAGNETIC LOW VOLTAGE (MLV)

PSDH-48W-24V	CLASS 2	11.25" X 3.37" X 3.25"
PSDH-96W-24V	CLASS 2	11.25" X 3.37" X 3.25"
PSDH-288W-24V	CLASS 2	14.25" X 8.43" X 4.43"

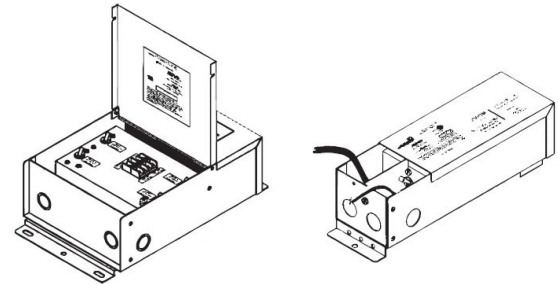

PSRX SERIES 4-IN-1 DIMMING DRIVER

PSRX-30W-24V	CLASS 2	6.5" X 3.72" X 1.57"
PSRX-60W-24V	CLASS 2	7.4" X 3.72" X 1.57"
PSRX-96W-24V	CLASS 2	8.66" X 3.72" X 1.57"
PSRX-150W-24V		10.24" X 4.13" X 1.77"
PSRX-192W-24V	CLASS 2	11" X 4" X 1.82"
PSRX-200W-24V		10.24" X 4.13" X 1.77"
PSRX-288W-24V	CLASS 2	11.85" X 4.25" X 1.82"
PSRX-300W-24V		10.94" X 4.33" X 1.77"

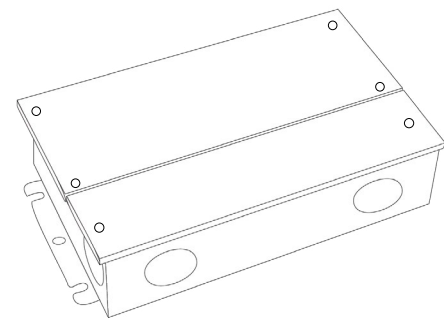

PSVT SERIES 0-10V DIMMING DRIVER

PSVT-60W-24V	CLASS 2	7.4" X 3.72" X 1.57"
PSVT-96W-24V	CLASS 2	8.66" X 3.72" X 1.57"
PSVT-200W-24V		10.24" X 4.13" X 1.77"
PSVT-288W-24V	CLASS 2	11.85" X 4.25" X 1.81"
PSVT-300W-24V		10.94" X 4.33" X 1.77"

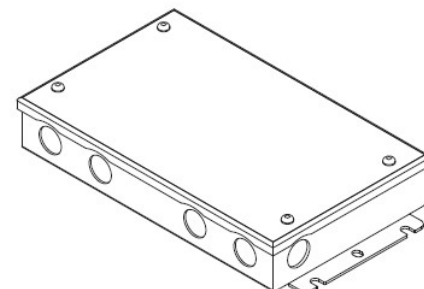

LNE-50 DUAL BEND

4.75W IP67 FLEXIBLE LED NEON SERIES

COMPATIBLE TRANSFORMERS

PSDE SERIES

0-10V DIMMING W/ JUNCTION BOX

PSDE-60W-24V-010-JB	CLASS 2	12.1" X 2.36" X 1.4"
PSDE-96W-24-010-JB	CLASS 2	12.1" X 2.36" X 1.4"

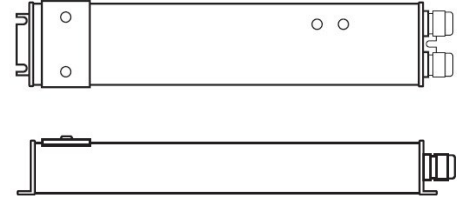

LUTRON 1%

3-WIRE DIMMING

L3DA4U1UKL-CV240	CLASS 2	4.89" X 4" X 2.62"
------------------	---------	--------------------

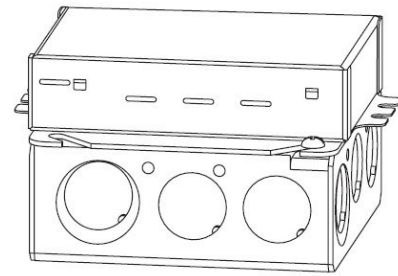

PSDE-96W-24V-ECO	CLASS 2	10.5" X 3.0" X 2.0"
------------------	---------	---------------------

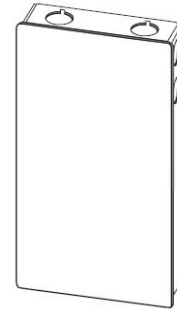

COMPATIBLE NON-DIMMING DRIVERS

PSHK SERIES

NON-DIMMING CONSTANT VOLTAGE WITH JUNCTION BOX

PSHK-30W-24V	CLASS 2	6.5" X 3.6" X 1.02"
PSHK-60W-24V	CLASS 2	7.4" X 3.62" X 1.02"
PSHK-96W-24V	CLASS 2	8.66" X 3.66" X 1.61"
PSHK-150W-24V		10.24" X 4.06" X 1.81"
PSHK-200W-24V		10.24" X 4.06" X 1.81"
PSHK-288W-24V	CLASS 2	11.85" X 4.25" X 1.82"
PSHK-300W-24V		10.24" X 4.25" X 1.81"

