

LNE-30

3W IP54/ IP67 FLEXIBLE LED NEON SERIES

Project _____
Location _____
Quote/ Ref # _____

The **LNE-30 Series** is a high performance flexible and affordable LED fixture designed as a neon replacement and is also useful in a wide variety of indoor or outdoor applications where a smooth surface or continuous line of light is desired. It is a flexible strip light that can bend around contours or tight curves horizontally or vertically without being damaged.



SPECIFICATIONS

POWER CONSUMPTION	3W per Ft.
LUMEN OUTPUT	215 Lumens per Ft. (30K)
CRI	90+
COLOR TEMPERATURE	24K/ 27K/ 30K/ 35K/ 40K/ 50K RD/ GN/ BL/ AM/ PK/ YW
DIMMING/ CONTROL	MLV, ELV, 0-10 and TRIAC
MAXIMUM RUN LENGTH	32 Ft.
CUTTABLE	Every 1.9 in. (50mm)
OPERATING VOLTAGE	24V DC
STORAGE TEMPERATURE	-40°F (-40°C) to 176°F (80°C)
OPERATING TEMPERATURE	-4°F (-20°C) to 113°F (45°C)
BEAM ANGLE	120°
IP RATING	IP54/ IP67
CERTIFICATIONS	UL Listed
LUMEN MAINTENANCE	50,000 Hrs.

FEATURES

- High color consistency and smooth illumination
- Multiple CCT options available
- Continuous run length up to 32 Ft.
- Cuttable every 1.9 in. (50mm)
- Bottom, Side and End Feed options
- UL Listed (US and Canada)



MODEL	LIGHT SURFACE	COLOR TEMP		VOLT	LENGTH	IP RATING	POWER FEED	FEED LENGTH
LNE-30	TP Top Bend	24K 2400K	RD Red	24 24V DC	1XX per Ft.	IP54* Damp	BF Bottom Feed	HW3 3 Ft. Power Feed
	SB Side Bend	27K 2700K	GN Green				SFL Side Feed Left	HW10 10 Ft. Power Feed
		30K 3000K	BL Blue				SFR Side Feed Right	HW15 15 Ft. Power Feed
		35K 3500K	AM Amber				EF End Feed	HW30 30 Ft. Power Feed
		40K 4000K	PK Pink					HW50 50 Ft. Power Feed
		50K 5000K	YW Yellow					

*1 = Custom length per FT. (cuttable every 1.9")

*Please see optional accessories on page 3

LNE-30

3W IP54/ IP67 FLEXIBLE LED NEON SERIES

DIMENSIONS

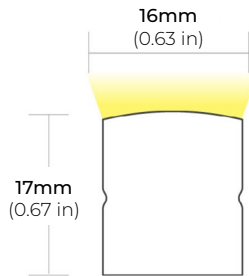

LNE-30-TP (TOP BEND)

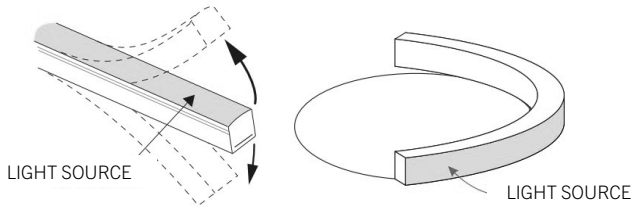

LNE-30-SB (SIDE BEND)

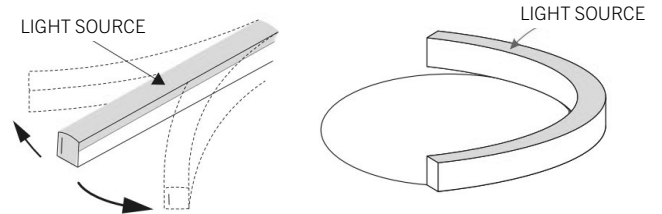

COMPATIBLE ACCESSORIES

SELF LOCKING ALUMINUM PROFILE

LNE30-AC2
2" PROFILE

LNE30-AC39
39" PROFILE



LNE-30

3W IP54/ IP67 FLEXIBLE LED NEON SERIES

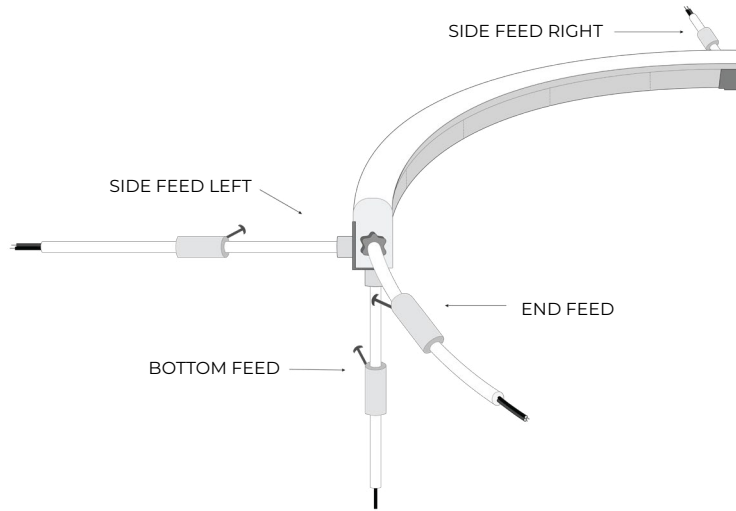

POWER FEED (IP54)

BF
BOTTOM FEED

LNE-IP54-BF-HW3 3 FT. BOTTOM FEED (IP54)

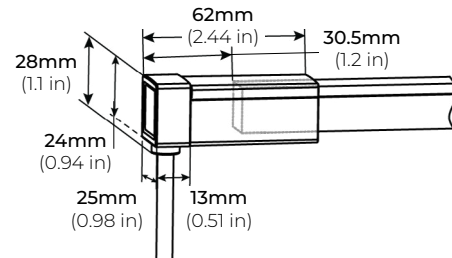

SFL
SIDE LEFT FEED

LNE-IP54-SFL-HW3 3 FT. SIDE FEED LEFT (IP54)

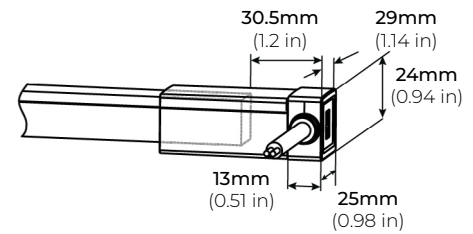

SFR
SIDE RIGHT FEED

LNE-IP54-SFR-HW3 3 FT. SIDE FEED RIGHT (IP54)

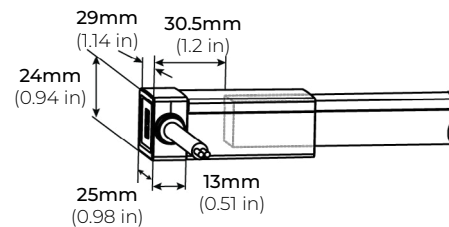

EF
END FEED

LNE-IP54-EF-HW3 3 FT. END FEED (IP54)
LNE-IP54-EF-HW10 10 FT. END FEED (IP54)

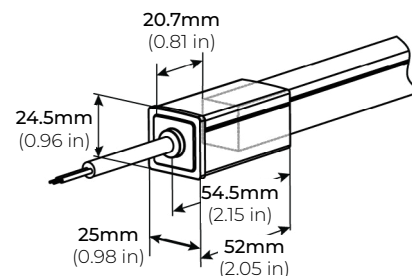

LNE-30

3W IP54/ IP67 FLEXIBLE LED NEON SERIES

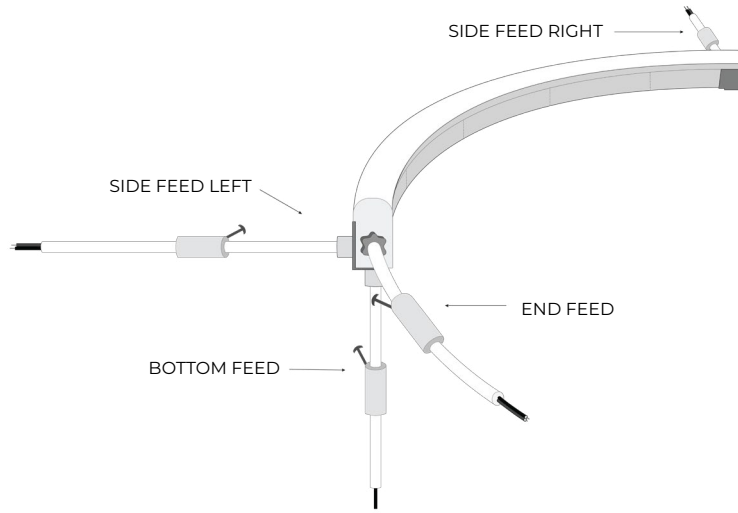

POWER FEED (IP67)

BF
BOTTOM FEED

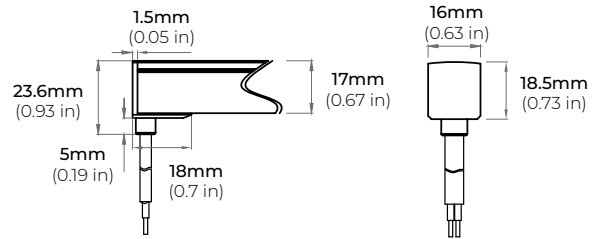

SFL
SIDE LEFT FEED

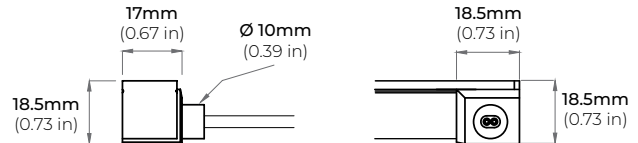

SFR
SIDE RIGHT FEED

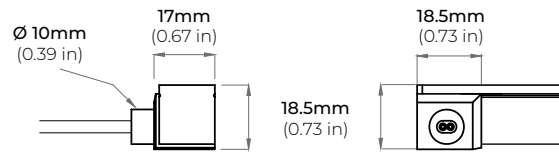

EF
END FEED

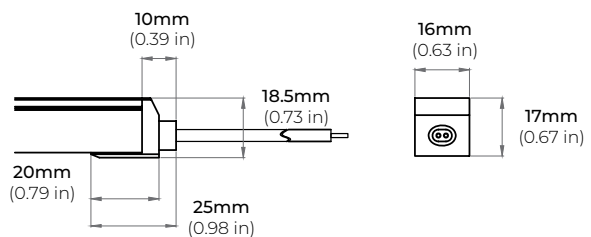

LNE-30

3W IP54/ IP67 FLEXIBLE LED NEON SERIES

COMPATIBLE TRANSFORMERS

PSDL SERIES TRIAC DIMMABLE

PSDL-30W-24V	CLASS 2	6.5" X 3.63" X 1.03"
PSDL-60W-24V	CLASS 2	7.4" X 3.63" X 1.03"
PSDL-96W-24V	CLASS 2	8.67" X 3.67" X 1.62"
PSDL-150W-24V		8.67" X 3.67" X 1.62"
PSDL-192W-24V	CLASS 2	10.25" X 4.06" X 1.82"
PSDL-200W-24V		10.25" X 4.06" X 1.82"
PSDL-288W-24V	CLASS 2	10.25" X 4.06" X 1.82"
PSDL-300W-24V		10.25" X 4.06" X 1.82"

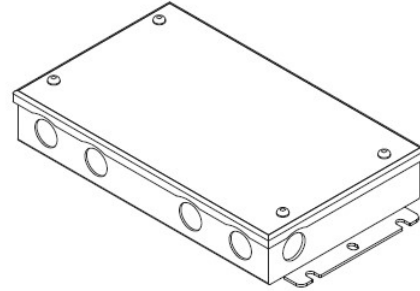

PSDH SERIES HIGH PERFORMANCE MAGNETIC LOW VOLTAGE (MLV)

PSDH-48W-24V	CLASS 2	11.25" X 3.37" X 3.25"
PSDH-96W-24V	CLASS 2	11.25" X 3.37" X 3.25"
PSDH-288W-24V	CLASS 2	14.25" X 8.43" X 4.43"

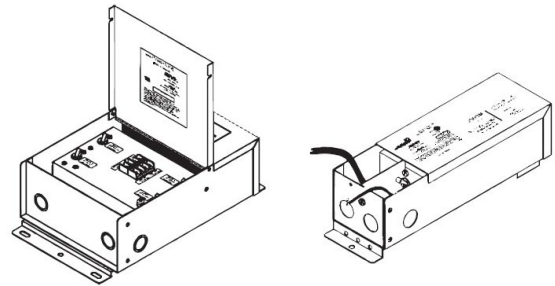

PSRX SERIES 4-IN-1 DIMMING DRIVER

PSRX-30W-24V	CLASS 2	6.5" X 3.72" X 1.57"
PSRX-60W-24V	CLASS 2	7.4" X 3.72" X 1.57"
PSRX-96W-24V	CLASS 2	8.66" X 3.72" X 1.57"
PSRX-150W-24V		10.24" X 4.13" X 1.77"
PSRX-192W-24V	CLASS 2	11" X 4" X 1.82"
PSRX-200W-24V		10.24" X 4.13" X 1.77"
PSRX-288W-24V	CLASS 2	11.85" X 4.25" X 1.82"
PSRX-300W-24V		10.94" X 4.33" X 1.77"

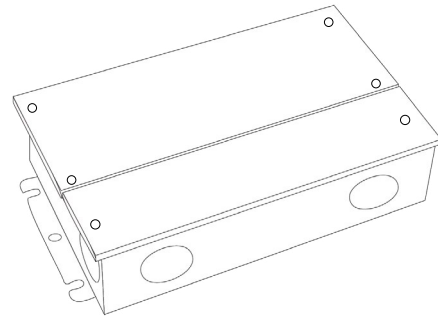

PSVT SERIES 0-10V DIMMING DRIVER

PSVT-60W-24V	CLASS 2	7.4" X 3.72" X 1.57"
PSVT-96W-24V	CLASS 2	8.66" X 3.72" X 1.57"
PSVT-200W-24V		10.24" X 4.13" X 1.77"
PSVT-288W-24V	CLASS 2	11.85" X 4.25" X 1.81"
PSVT-300W-24V		10.94" X 4.33" X 1.77"

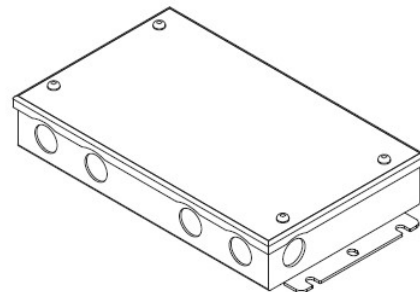

LNE-30

3W IP54/ IP67 FLEXIBLE LED NEON SERIES

COMPATIBLE TRANSFORMERS

PSDE SERIES

0-10V DIMMING W/ JUNCTION BOX

PSDE-60W-24V-010-JB	CLASS 2	12.1" X 2.36" X 1.4"
PSDE-96W-24-010-JB	CLASS 2	12.1" X 2.36" X 1.4"

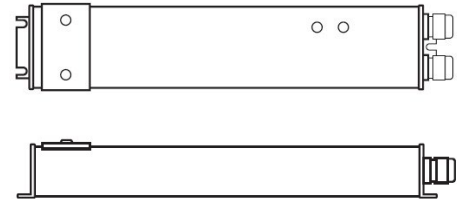

LUTRON 1%

3-WIRE DIMMING

L3DA4U1UKL-CV240	CLASS 2	4.89" X 4" X 2.62"
------------------	---------	--------------------

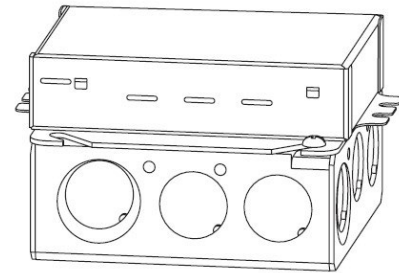

PSDE-96W-24V-ECO	CLASS 2	10.5" X 3.0" X 2.0"
------------------	---------	---------------------

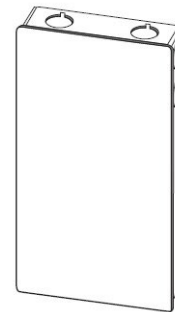

COMPATIBLE NON-DIMMING DRIVERS

PSHK SERIES

NON-DIMMING CONSTANT VOLTAGE WITH JUNCTION BOX

PSHK-30W-24V	CLASS 2	6.5" X 3.6" X 1.02"
PSHK-60W-24V	CLASS 2	7.4" X 3.62" X 1.02"
PSHK-96W-24V	CLASS 2	8.66" X 3.66" X 1.61"
PSHK-150W-24V		10.24" X 4.06" X 1.81"
PSHK-200W-24V		10.24" X 4.06" X 1.81"
PSHK-288W-24V	CLASS 2	11.85" X 4.25" X 1.82"
PSHK-300W-24V		10.24" X 4.25" X 1.81"

