

LNE-15

IP54/ IP67 FLEXIBLE LED NEON SERIES

The **LNE-15 Series** is a high performance flexible and affordable LED fixture designed as a neon replacement and is also useful in a wide variety of indoor or outdoor applications where a smooth surface or continuous line of light is desired. It is a flexible strip light that can bend around contours or tight curves horizontally or vertically without being damaged.

Project _____
Location _____
Quote/ Ref # _____



SPECIFICATIONS

POWER CONSUMPTION	Up to 3W per Ft.
LUMEN OUTPUT	Up to 186 Lumens per Ft.
CRI	90+
COLOR TEMPERATURE	22K/ 24K/ 27K/ 30K/ 35K/ 40K/ 50K RD/ GN/ BL/ AM/ PK/ YW
DIMMING/ CONTROL	MLV, ELV, 0-10 and TRIAC
MAXIMUM RUN LENGTH	32 Ft.
CUTTABLE	Every 3.25 in. (82.6mm)
OPERATING VOLTAGE	24V DC
STORAGE TEMPERATURE	-40°F (-40°C) to 176°F (80°C)
OPERATING TEMPERATURE	-4°F (-20°C) to 113°F (45°C)
BEAM ANGLE	120°
IP RATING	IP54/ IP67
CERTIFICATIONS	UL Listed
LUMEN MAINTENANCE	50,000 Hrs.

FEATURES

- High color consistency and smooth illumination
- Multiple CCT options available
- Continuous run length up to 32 Ft.
- Cuttable every 3.25 in. (82.6mm)
- Bottom, Side and End Feed options
- UL Listed (US and Canada)

LUMENS

MODEL	WATT	LM/ FT
LNE-15	1W	62
	2W	124
	3W	186



MODEL	SURFACE	WATTS	COLOR TEMP	VOLT	LENGTH	IP RATING	POWER FEED	FEED LENGTH	
LNE-15	TP Top Bend	1 1W	22K 2200K	RD Red	24 24V DC	1XX per Ft.	BF Bottom Feed	HW3 3 Ft. Power Feed	
	SB Side Bend	2 2W	24K 2400K	GN Green			IP67 Wet	SFL Side Feed Left	HW10 10 Ft. Power Feed
		3 3W	27K 2700K	BL Blue			SFR Side Feed Right	HW15 15 Ft. Power Feed	
			30K 3000K	AM Amber			EF End Feed		
			35K 3500K	PK Pink					
			40K 4000K	YW Yellow					
			50K 5000K						

LNE-15

IP54/ IP67 FLEXIBLE LED NEON SERIES

DIMENSIONS

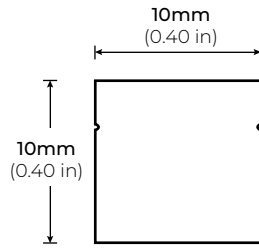

LNE-15-TP (TOP BEND)

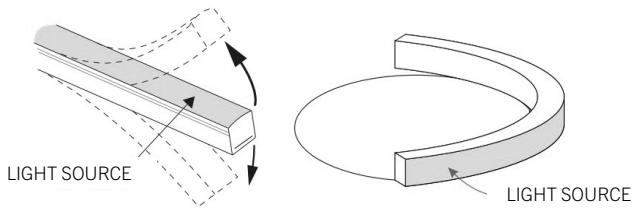

LNE-15B -SB (SIDE BEND)

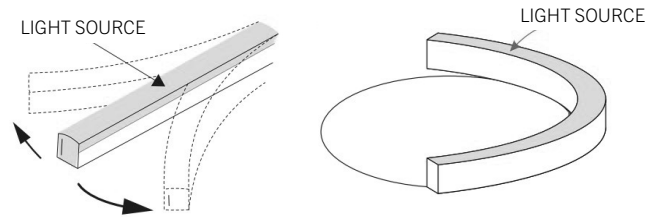

LIGHT DISTRIBUTION

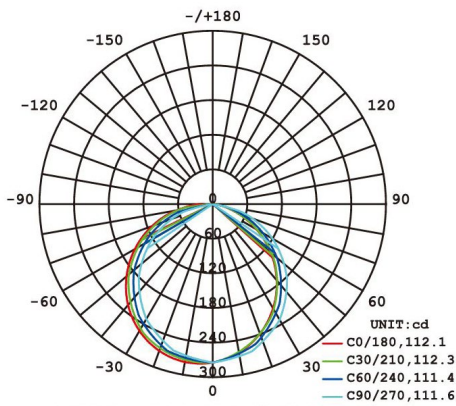

LNE-15-TP (TOP BEND)

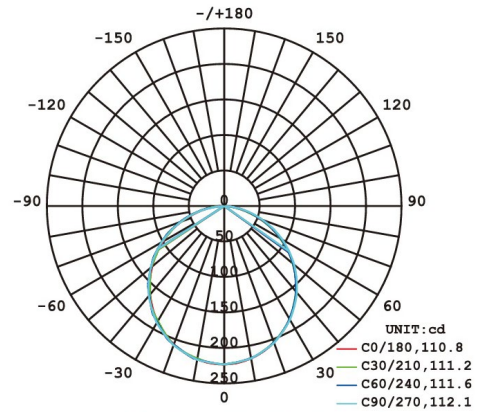

LNE-15B -SB (SIDE BEND)

LNE-15

IP54/ IP67 FLEXIBLE LED NEON SERIES

COMPATIBLE ACCESSORIES

SELF LOCKING ALUMINUM PROFILE

LNE15-AC2
2" PROFILE

LNE15-AC39
39" PROFILE

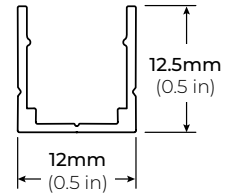
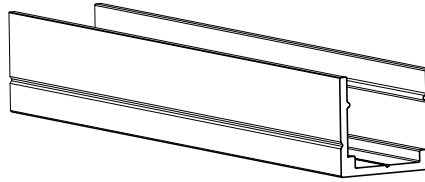

FLEXIBLE ALUMINUM PROFILE

LNE15-AFX39
39" PROFILE

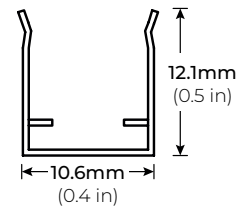
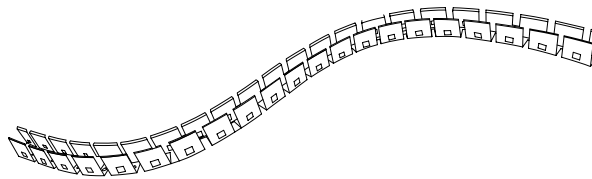

LNE-15

IP54/ IP67 FLEXIBLE LED NEON SERIES

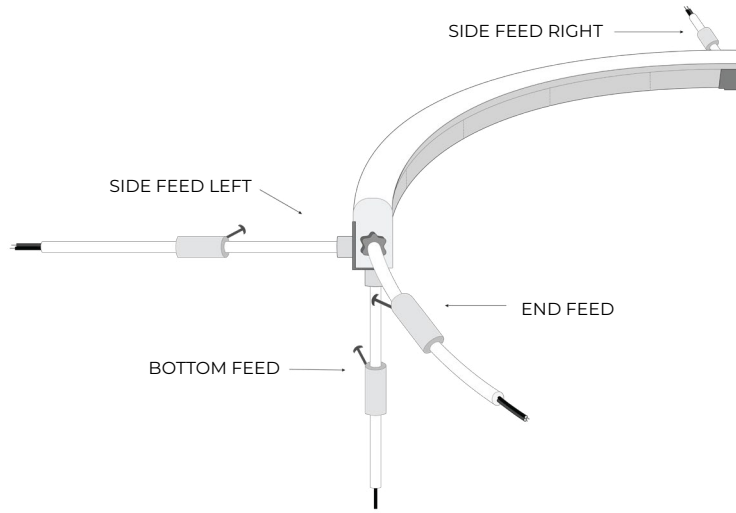

POWER FEED (IP54)

BF
BOTTOM FEED

LNE-IP54-BF-HW3 3 FT. BOTTOM FEED (IP54)

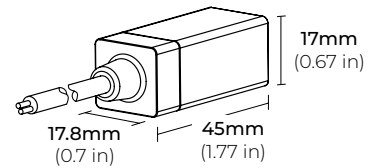

SFL
SIDE LEFT FEED

LNE-IP54-SFL-HW3 3 FT. SIDE FEED LEFT (IP54)

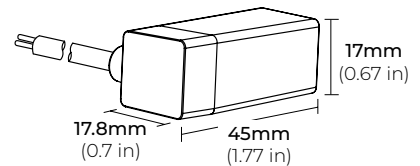

SFR
SIDE RIGHT FEED

LNE-IP54-SFR-HW3 3 FT. SIDE FEED RIGHT (IP54)

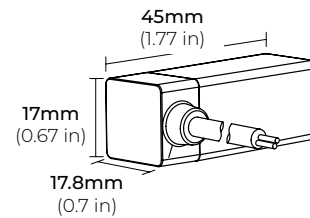

EF
END FEED

LNE-IP54-EF-HW3 3 FT. END FEED (IP54)
LNE-IP54-EF-HW10 10 FT. END FEED (IP54)

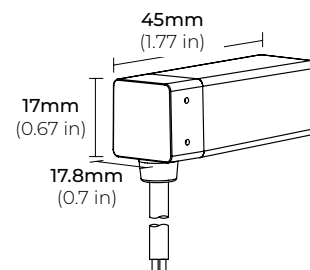

LNE-15

IP54/ IP67 FLEXIBLE LED NEON SERIES

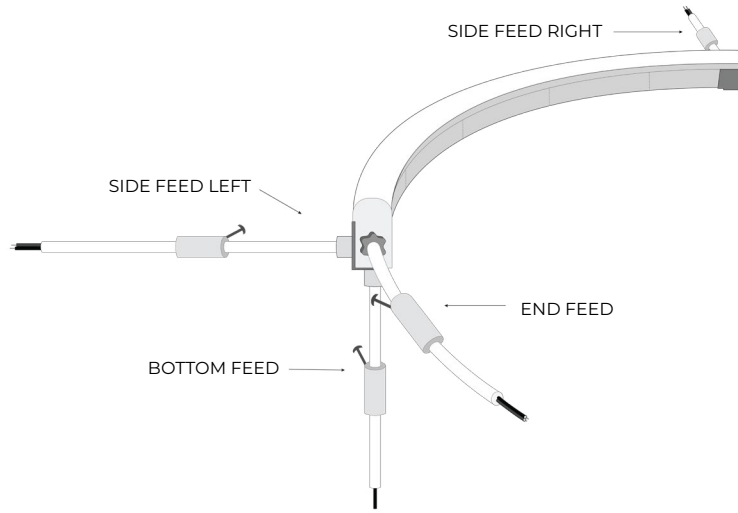

POWER FEED (IP67)

BF
BOTTOM FEED

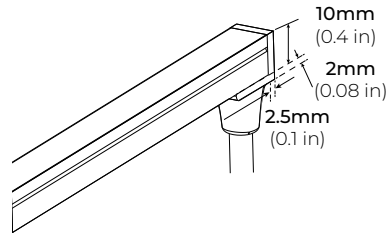

SFL
SIDE LEFT FEED

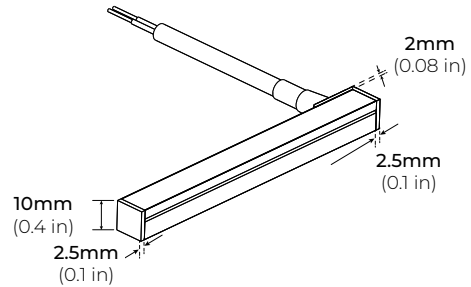

SFR
SIDE RIGHT FEED

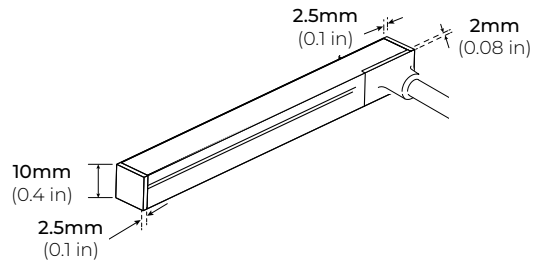

EF
END FEED

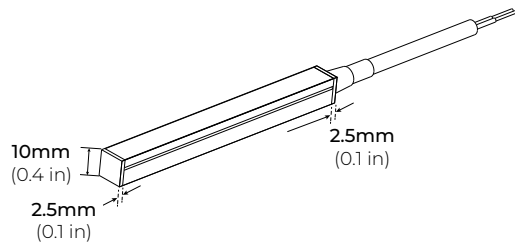

LNE-15

IP54/ IP67 FLEXIBLE LED NEON SERIES

COMPATIBLE TRANSFORMERS

PSDL SERIES TRIAC DIMMABLE

PSDL-30W-24V	CLASS 2	6.5" X 3.63" X 1.03"
PSDL-60W-24V	CLASS 2	7.4" X 3.63" X 1.03"
PSDL-96W-24V	CLASS 2	8.67" X 3.67" X 1.62"
PSDL-150W-24V		8.67" X 3.67" X 1.62"
PSDL-192W-24V	CLASS 2	10.25" X 4.06" X 1.82"
PSDL-200W-24V		10.25" X 4.06" X 1.82"
PSDL-288W-24V	CLASS 2	10.25" X 4.06" X 1.82"
PSDL-300W-24V		10.25" X 4.06" X 1.82"

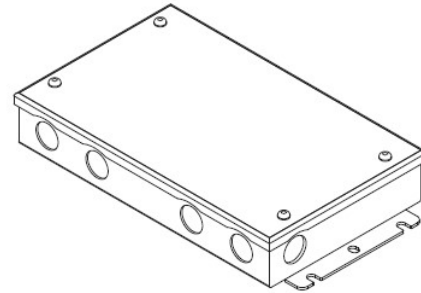

PSDH SERIES HIGH PERFORMANCE MAGNETIC LOW VOLTAGE (MLV)

PSDH-48W-24V	CLASS 2	11.25" X 3.37" X 3.25"
PSDH-96W-24V	CLASS 2	11.25" X 3.37" X 3.25"
PSDH-288W-24V	CLASS 2	14.25" X 8.43" X 4.43"

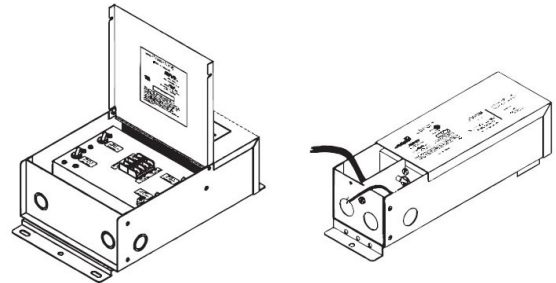

PSRX SERIES 4-IN-1 DIMMING DRIVER

PSRX-30W-24V	CLASS 2	6.5" X 3.72" X 1.57"
PSRX-60W-24V	CLASS 2	7.4" X 3.72" X 1.57"
PSRX-96W-24V	CLASS 2	8.66" X 3.72" X 1.57"
PSRX-150W-24V		10.24" X 4.13" X 1.77"
PSRX-192W-24V	CLASS 2	11" X 4" X 1.82"
PSRX-200W-24V		10.24" X 4.13" X 1.77"
PSRX-288W-24V	CLASS 2	11.85" X 4.25" X 1.82"
PSRX-300W-24V		10.94" X 4.33" X 1.77"

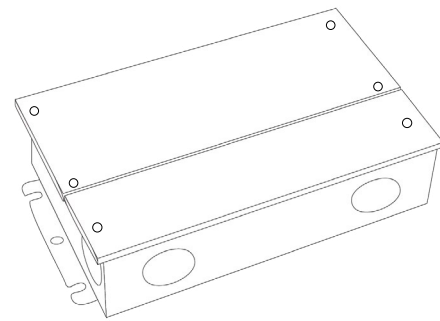

PSVT SERIES 0-10V DIMMING DRIVER

PSVT-60W-24V	CLASS 2	7.4" X 3.72" X 1.57"
PSVT-96W-24V	CLASS 2	8.66" X 3.72" X 1.57"
PSVT-200W-24V		10.24" X 4.13" X 1.77"
PSVT-288W-24V	CLASS 2	11.85" X 4.25" X 1.81"
PSVT-300W-24V		10.94" X 4.33" X 1.77"

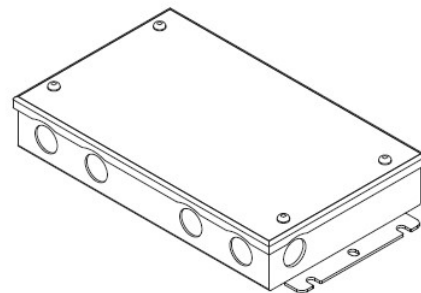

LNE-15

IP54/ IP67 FLEXIBLE LED NEON SERIES

COMPATIBLE TRANSFORMERS

PSDE SERIES

0-10V DIMMING W/ JUNCTION BOX

PSDE-60W-24V-010-JB	CLASS 2	12.1" X 2.36" X 1.4"
PSDE-96W-24-010-JB	CLASS 2	12.1" X 2.36" X 1.4"

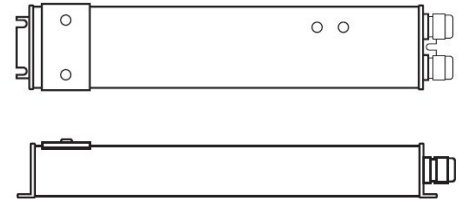

LUTRON 1%

3-WIRE DIMMING

L3DA4U1UKL-CV240	CLASS 2	4.0" X 1.5" X 4.0"
------------------	---------	--------------------

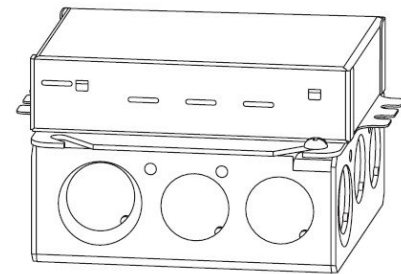

PSDE-96W-24V-ECO	CLASS 2	10.5" X 3.0" X 2.0"
------------------	---------	---------------------

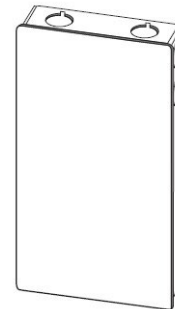

COMPATIBLE NON-DIMMING DRIVERS

PSHK SERIES

NON-DIMMING CONSTANT VOLTAGE WITH JUNCTION BOX

PSHK-30W-24V	CLASS 2	6.5" X 3.6" X 1.02"
PSHK-60W-24V	CLASS 2	7.4" X 3.62" X 1.02"
PSHK-96W-24V	CLASS 2	8.66" X 3.66" X 1.61"
PSHK-150W-24V		10.24" X 4.06" X 1.81"
PSHK-200W-24V		10.24" X 4.06" X 1.81"
PSHK-288W-24V	CLASS 2	11.85" X 4.25" X 1.82"
PSHK-300W-24V		10.24" X 4.25" X 1.81"

