

LUCA

SUSPENDED LINEAR LED SYSTEM

Project _____
Location _____
Quote/ Ref # _____

LUCA is a versatile and efficient suspended linear LED lighting system available in different lengths and color temperatures. It features a unique design that allows it to swivel 360° to direct its light source in any chosen direction. Seamless and continuous run installations deliver efficient illumination.



SPECIFICATIONS

TYPE	Suspended Mount
POWER CONSUMPTION	3W/ Ft. 5W/ Ft. 7W/ Ft.
INPUT VOLTAGE	24V
LUMEN OUTPUT	Up to 830 Lumens
CRI	90+
COLOR TEMPERATURE	27K/ 30K/ 35K/ 40K/ 50K
DIMMING	ELV, 0-10V and TRIAC
DRIVER	Remote
MAXIMUM RUN LENGTH	Linkable up to 20 Ft.
AVAILABLE LENGTHS	24 in./ 36 in./ 48 in./ 72 in.
LUMEN MAINTENANCE	50,000 Hrs.
CERTIFICATIONS	ETL Listed

FEATURES

- Slim Profile, Modular Design
- Tight, Smooth fixture rotation for directional light aiming
- 360° Rotate
- Extruded Anodized Aluminum
- Exceptional light distribution and efficacy

LUMENS

LIGHT OUTPUT	WATTS (W/FT.)	LM/ FT.
L2	3	307
L3	5	596
L4	7	830

*Approved for closet / storage space installation per NEC 410.16(A)(3) and 410.16(C)(5)



MODEL	LENGTH	OUTPUT	CCT	FINISH	LENS	POWER FEED	DRIVER	ACCESSORIES
LUCA	24 24 in.	L2 3W	27K 2700K	BA Brushed Aluminum	FR Frosted	<u>5" Canopy</u> RC5 Suspended End Power Feed	See pages 6-7 for compatible drivers	See page 5 for options
	36 36 in.	L3 5W	30K 3000K	BK Black		RC5-L Suspended Side Power Feed Left		
	48 48 in.	L4 7W	35K 3500K	WH White		RC5-R Suspended Side Power Feed Right		
	72 72 in.		40K 4000K					
						<u>2" Canopy</u> RC2 Suspended End Power Feed		
						RC2-L Suspended Side Power Feed Left		
						RC2-R Suspended Side Power Feed Right		

LUCA

SUSPENDED LINEAR LED SYSTEM

DIMENSIONS

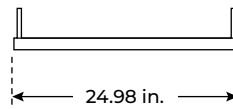
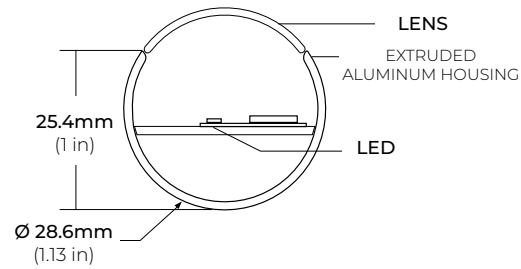

LUCA-24

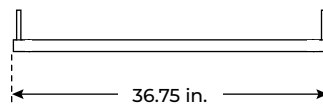

LUCA-36

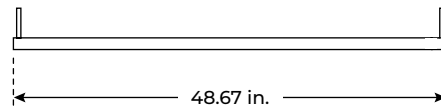

LUCA-48

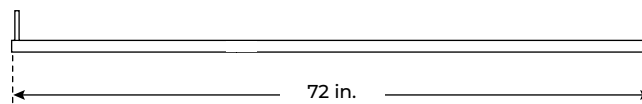

LUCA-72

SUSPENDED LINEAR LED SYSTEM

5" CANOPY POWER FEED SUSPENSION KIT

RC5
SUSPENDED END POWER FEED KIT

* 60" AIRCRAFT CABLE INCLUDED

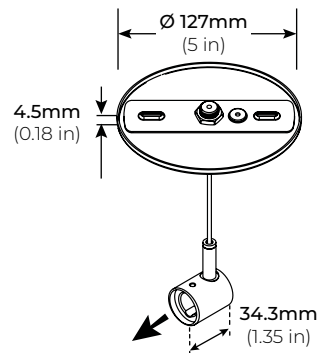

RC5-L
SUSPENDED SIDE POWER FEED (LEFT) KIT

* 60" AIRCRAFT CABLE INCLUDED

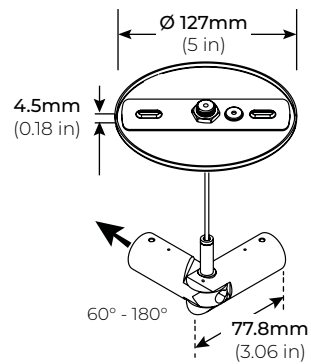

RC5-R
SUSPENDED SIDE POWER FEED (RIGHT) KIT

* 60" AIRCRAFT CABLE INCLUDED

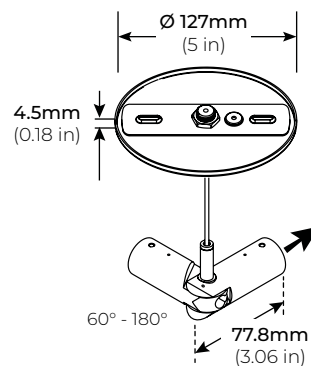

SUSPENDED LINEAR LED SYSTEM

2" CANOPY POWER FEED SUSPENSION KIT

RC2
SUSPENDED END POWER FEED KIT

* 60" AIRCRAFT CABLE INCLUDED

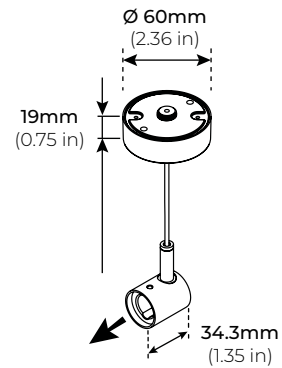

RC2-L
SUSPENDED SIDE POWER FEED (LEFT) KIT

* 60" AIRCRAFT CABLE INCLUDED

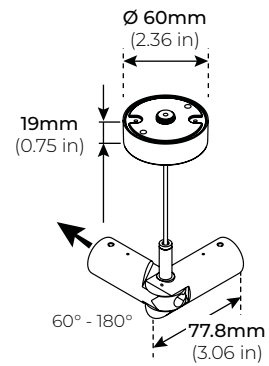

RC2-R
SUSPENDED SIDE POWER FEED (RIGHT) KIT

* 60" AIRCRAFT CABLE INCLUDED

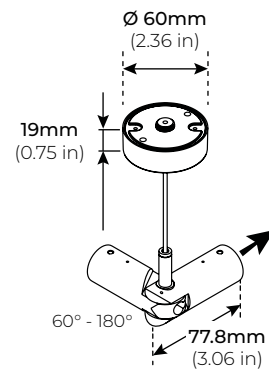

SUSPENDED LINEAR LED SYSTEM

COMPATIBLE ACCESSORIES

ECS SUSPENDED END CAP

* 60" AIRCRAFT CABLE INCLUDED

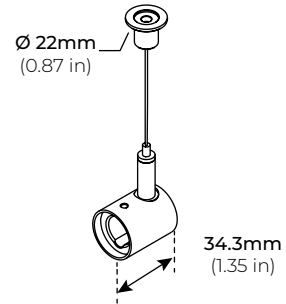

DHS SUSPENDED DOUBLE-END CONNECTOR

* 60" AIRCRAFT CABLE INCLUDED

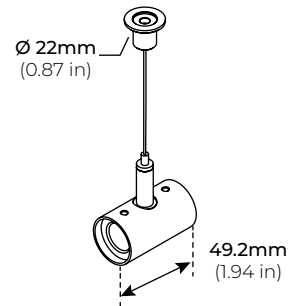

SAN SUSPENDED ANGLED CONNECTOR (NON-POWER)

* 60" AIRCRAFT CABLE INCLUDED

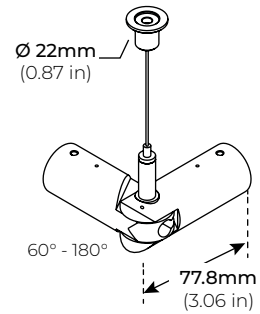

SAP SUSPENDED ANGLED CONNECTOR (POWER)

* 60" AIRCRAFT CABLE INCLUDED

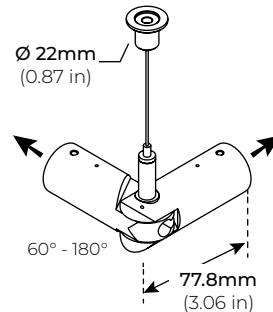

SUSPENDED LINEAR LED SYSTEM

COMPATIBLE TRANSFORMERS

PSDL SERIES TRIAC DIMMABLE

PSDL-30W-24V	CLASS 2	6.5" X 3.63" X 1.03"
PSDL-60W-24V	CLASS 2	7.4" X 3.63" X 1.03"
PSDL-96W-24V	CLASS 2	8.67" X 3.67 X 1.62"
PSDL-150W-24V		8.67" X 3.67" X 1.62"
PSDL-192W-24V	CLASS 2	10.25" X 4.06" X 1.82"
PSDL-200W-24V		10.25" X 4.06" X 1.82"
PSDL-288W-24V	CLASS 2	10.25" X 4.06" X 1.82"
PSDL-300W-24V		10.25" X 4.06" X 1.82"

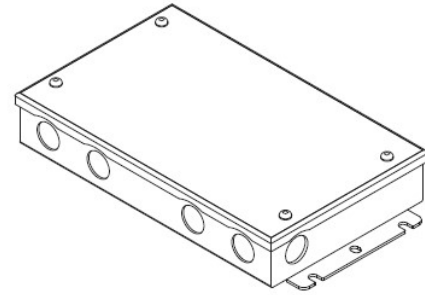

PSRX SERIES 4-IN-1 DIMMING DRIVER

PSRX-30W-24V	CLASS 2	6.5" X 3.72" X 1.57"
PSRX-60W-24V	CLASS 2	7.4" X 3.72" X 1.57"
PSRX-96W-24V	CLASS 2	8.66" X 3.72" X 1.57"
PSRX-150W-24V		10.24" X 4.13" X 1.77"
PSRX-192W-24V	CLASS 2	11" X 4" X 1.82"
PSRX-200W-24V		10.24" X 4.13" X 1.77"
PSRX-288W-24V	CLASS 2	11.85" X 4.25" X 1.82"
PSRX-300W-24V		10.94" X 4.33" X 1.77"

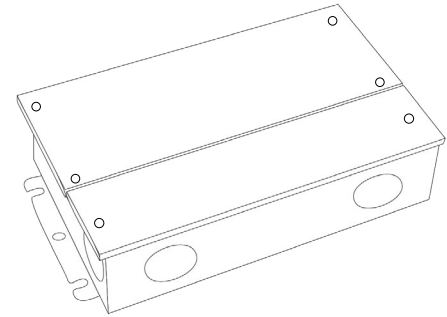

PSVT SERIES 0-10V DIMMING DRIVER

PSVT-60W-24V	CLASS 2	7.4" X 3.72" X 1.57"
PSVT-96W-24V	CLASS 2	8.66" X 3.72" X 1.57"
PSVT-200W-24V		10.24" X 4.13" X 1.77"
PSVT-288W-24V	CLASS 2	11.85" X 4.25" X 1.81"
PSVT-300W-24V		10.94" X 4.33" X 1.77"

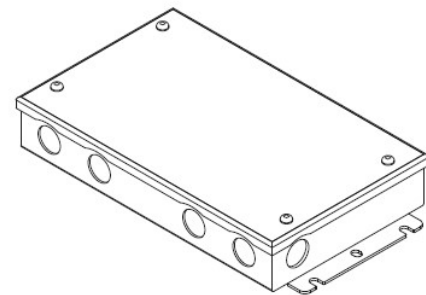

PSDE SERIES 0-10V DIMMING W/ JUNCTION BOX

PSDE-60W-24V-010-JB	CLASS 2	12.1" X 2.36" X 1.4"
PSDE-96W-24V-010-JB	CLASS 2	12.1" X 2.36" X 1.4"

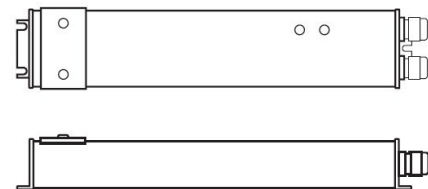

SUSPENDED LINEAR LED SYSTEM

COMPATIBLE TRANSFORMERS

LUTRON 1%
3-WIRE DIMMING

L3DA4U1UKL-CV240 CLASS 2 4.89" X 4" X 2.62"

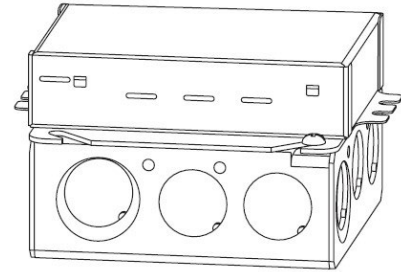

PSDE-96W-24V-ECO CLASS 2 10.5" X 3.0" X 2.0"

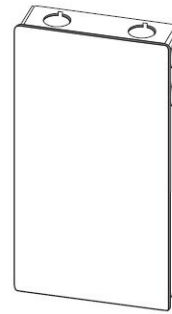

NON-DIMMING DRIVERS (COMPATABLE WITH ALL SYSTEMS)

PSHK SERIES
NON-DIMMING CONSTANT VOLTAGE WITH JUNCTION BOX

PSHK-30W-24V	CLASS 2	6.5" X 3.6" X 1.02"
PSHK-60W-24V	CLASS 2	7.4" X 3.62" X 1.02"
PSHK-96W-24V	CLASS 2	8.66" X 3.66" X 1.61"
PSHK-150W-24V		10.24" X 4.06" X 1.81"
PSHK-200W-24V		10.24" X 4.06" X 1.81"
PSHK-288W-24V	CLASS 2	11.85" X 4.25" X 1.82"
PSHK-300W-24V		10.24" X 4.25" X 1.81"

