

# LNT-45

## 4.4W IP65 FLEXIBLE LED NEON SERIES

Project \_\_\_\_\_

Location \_\_\_\_\_

Quote/ Ref # \_\_\_\_\_

**LNT45** is a high performance flexible LED fixture designed as a neon replacement. Suitable for indoor and outdoor applications, the LNT45 easily bends around contours and tight curves without being damaged. It allows for easy installation with its factory sealed terminators and self-locking male and female barrel connectors.

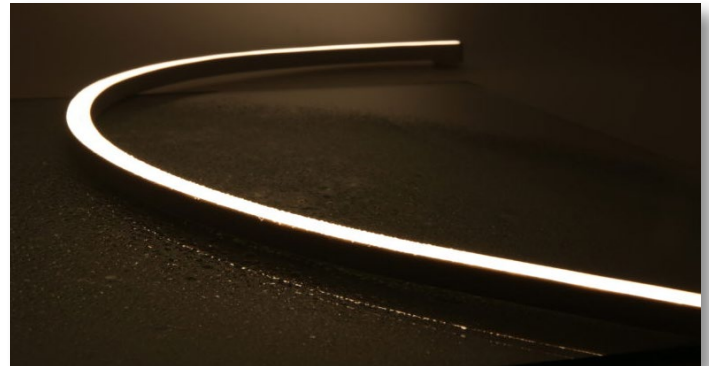

### SPECIFICATIONS

INPUT VOLTAGE	24V DC Constant Voltage
POWER CONSUMPTION	4.4W per Ft.
LUMEN OUTPUT	140 Lm/ Ft.
CRI	88+
COLOR TEMPERATURE	27K/ 30K/ 40K/ BL
DIMMING/ CONTROL	MLV, ELV, 0-10 and TRIAC
MAXIMUM RUN LENGTH	32 Ft.
CUTTABLE	Every 100.1mm (3.94 in)
POWER FACTOR	≤ 1
STORAGE TEMPERATURE	-40°F (-40°C) to 140°F (60°C)
OPERATING TEMPERATURE	-40°F (-40°C) to 131°F (55°C)
BEAM ANGLE	160°
HUMIDITY	0-95% Non Condensing
IP RATING	IP65
CERTIFICATIONS	UL Listed
LUMEN MAINTENANCE	50,000 Hrs.

### FEATURES

- High color consistency
- Smooth illumination
- Continuous run length up to 32 Ft.
- Dimmable with CORE dimmable drivers
- UL Listed



MODEL	LENS	COLOR TEMP	VOLTAGE	LENGTH	POWER FEED	FEED LENGTH
LNT-45	F Flat	<b>27K</b> 2700K	<b>24</b> 24V DC	Please refer to page 4 for exact lengths with corresponding ordering codes.	<b>IP65EF</b> End Feed	<b>HW36</b> 36 In. Power Feed
		<b>30K</b> 3000K				<b>HW120</b> 120 In. Power Feed
		<b>40K</b> 4000K				
		<b>BL</b> Blue				

# LNT-45

## 4.4W IP65 FLEXIBLE LED NEON SERIES

### DIMENSIONS

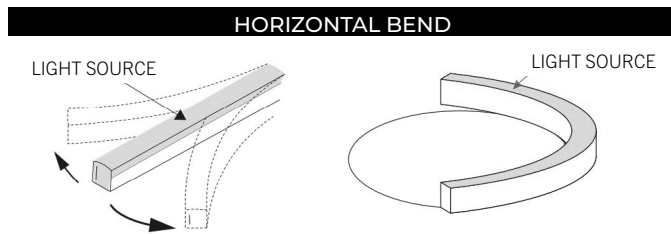
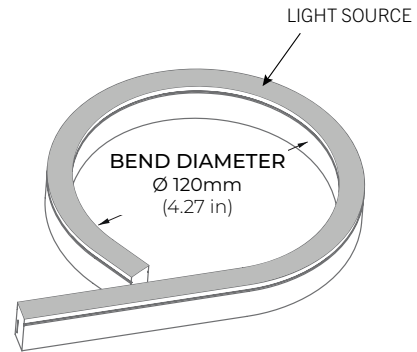
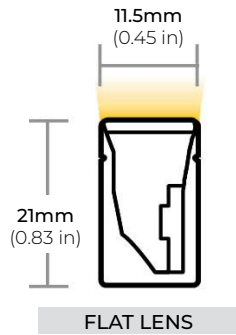

\* LED strip only bends along horizontal axis. Bending the LED strip vertically (perpendicular) to the light surface risks damage to the LED strip. Do **NOT** bend more than the indicated bend radius (shown above). Doing so will damage the LED strip.

### COMPATIBLE ACCESSORIES

#### SELF LOCKING ALUMINUM PROFILE

LNT45-AC2  
2" PROFILE

LNT45-AC39  
39" PROFILE

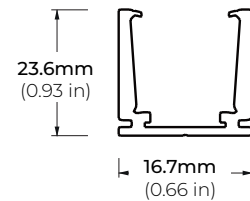

#### FLEXIBLE ALUMINUM CHANNEL

LNT45-AFX  
39" CHANNEL

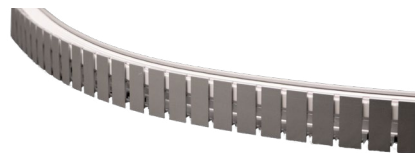

#### PLASTIC PROFILE

LNT45-PC39  
39" PROFILE

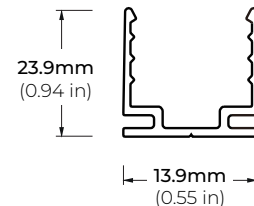

LNT45-BKT-ADJ  
ADJUSTABLE BRACKET

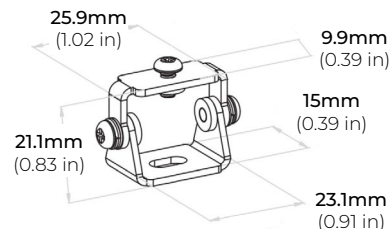

# LNT-45

## 4.4W IP65 FLEXIBLE LED NEON SERIES

### POWER FEED

IP65EF  
END FEED

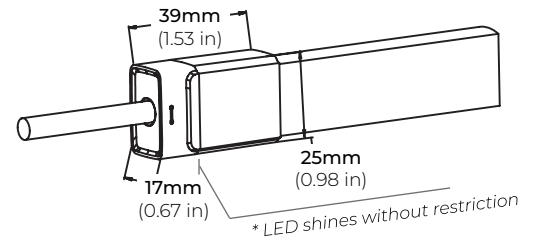

IP65EC  
END CAP

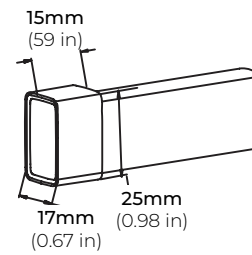

# LNT-45

## 4.4W IP65 FLEXIBLE LED NEON SERIES

### CUTTING LENGTH CODES

LNT-45 Series is cuttable every 3.94" (10CM). Please refer to the chart below to determine actual lengths once LED is cut versus actual lengths required or specified.

Total Length Calculation = Order Code Length + End Feed option Length  
**Example: 60.63" Total Length = Order Code 15 (59.1") + (1.53") End Feed**

POWER FEED OPTION	LENGTH
END FEED	1.53 INCHES

### CUTTING LENGTH INCREMENT TABLE

CODE	LENGTH (CM)	LENGTH (IN)
1	10	3.94
2	20	7.88
3	30	11.82
4	40	15.76
5	50	19.7
6	60	23.64
7	70	27.58
8	80	31.52
9	90	35.46
10	100	39.4
11	110	43.34
12	120	47.28
13	130	51.22
14	140	55.16
15	150	59.1
16	160	63.04
17	170	66.98
18	180	70.92
19	190	74.86
20	200	78.8
21	210	82.74
22	220	86.68
23	230	90.62
24	240	94.56
25	250	98.5
26	260	102.44
27	270	106.38
28	280	110.32
29	290	114.26
30	300	118.2
31	310	122.14
32	320	126.08
33	330	130.02
34	340	133.96
35	350	137.9
36	360	141.84
37	370	145.78
38	380	149.72
39	390	153.66
40	400	157.6

CODE	LENGTH (CM)	LENGTH (IN)
41	410	161.54
42	420	165.48
43	430	169.42
44	440	173.36
45	450	177.3
46	460	181.24
47	470	185.18
48	480	189.12
49	490	193.06
50	500	197
51	510	200.94
52	520	204.88
53	530	208.82
54	540	212.76
55	550	216.7
56	560	220.64
57	570	224.58
58	580	228.52
59	590	232.46
60	600	236.4
61	610	240.34
62	620	244.28
63	630	248.22
64	640	252.16
65	650	256.1
66	660	260.04
67	670	263.98
68	680	267.92
69	690	271.86
70	700	275.8
71	710	279.74
72	720	283.68
73	730	287.62
74	740	291.56
75	750	295.5
76	760	299.44
77	770	303.38
78	780	307.32
79	790	311.26
80	800	315.2

CODE	LENGTH (CM)	LENGTH (IN)
81	810	319.14
82	820	323.08
83	830	327.02
84	840	330.96
85	850	334.9
86	860	338.84
87	870	342.78
88	880	346.72
89	890	350.66
90	900	354.6
91	910	358.54
92	920	362.48
93	930	366.42
94	940	370.36
95	950	374.3
96	960	378.24
97	970	382.18
98	980	386.12
99	990	390.06
100	1000	394

# LNT-45

## 4.4W IP65 FLEXIBLE LED NEON SERIES

### COMPATIBLE TRANSFORMERS

#### PSDL SERIES TRIAC DIMMABLE

PSDL-30W-24V	CLASS 2	6.5" X 3.63" X 1.03"
PSDL-60W-24V	CLASS 2	7.4" X 3.63" X 1.03"
PSDL-96W-24V	CLASS 2	8.67" X 3.67 X 1.62"
PSDL-150W-24V		8.67" X 3.67" X 1.62"
PSDL-192W-24V	CLASS 2	10.25" X 4.06" X 1.82"
PSDL-200W-24V		10.25" X 4.06" X 1.82"
PSDL-288W-24V	CLASS 2	10.25" X 4.06" X 1.82"
PSDL-300W-24V		10.25" X 4.06" X 1.82"

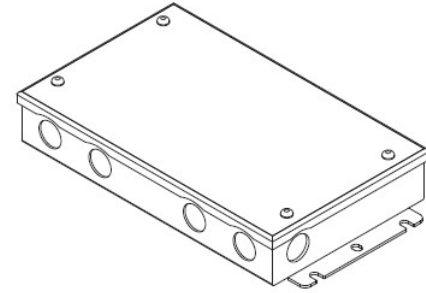

#### PSDH SERIES HIGH PERFORMANCE MAGNETIC LOW VOLTAGE (MLV)

PSDH-48W-24V	CLASS 2	11.25" X 3.37" X 3.25"
PSDH-96W-24V	CLASS 2	11.25" X 3.37" X 3.25"
PSDH-288W-24V	CLASS 2	14.25" X 8.43" X 4.43"

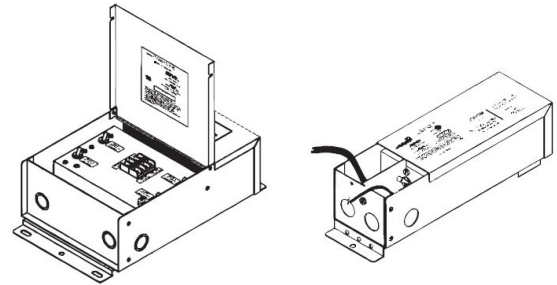

#### PSRX SERIES 4-IN-1 DIMMING DRIVER

PSRX-30W-24V	CLASS 2	6.5" X 3.72" X 1.57"
PSRX-60W-24V	CLASS 2	7.4" X 3.72" X 1.57"
PSRX-96W-24V	CLASS 2	8.66" X 3.72" X 1.57"
PSRX-150W-24V		10.24" X 4.13" X 1.77"
PSRX-192W-24V	CLASS 2	11" X 4" X 1.82"
PSRX-200W-24V		10.24" X 4.13" X 1.77"
PSRX-288W-24V	CLASS 2	11.85" X 4.25" X 1.82"
PSRX-300W-24V		10.94" X 4.33" X 1.77"

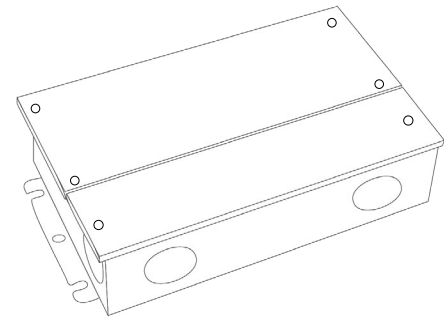

#### PSVT SERIES 0-10V DIMMING DRIVER

PSVT-60W-24V	CLASS 2	7.4" X 3.72" X 1.57"
PSVT-96W-24V	CLASS 2	8.66" X 3.72" X 1.57"
PSVT-200W-24V		10.24" X 4.13" X 1.77"
PSVT-288W-24V	CLASS 2	11.85" X 4.25" X 1.81"
PSVT-300W-24V		10.94" X 4.33" X 1.77"

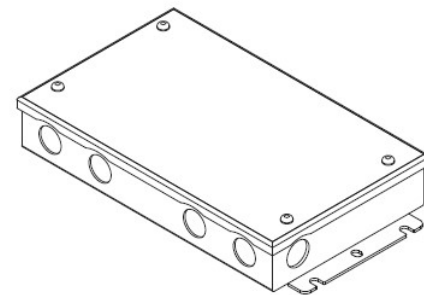

# LNT-45

## 4.4W IP65 FLEXIBLE LED NEON SERIES

### COMPATIBLE TRANSFORMERS

#### PSDE SERIES

0-10V DIMMING W/ JUNCTION BOX

PSDE-60W-24V-010-JB	CLASS 2	12.1" X 2.36" X 1.4"
PSDE-96W-24V-010-JB	CLASS 2	12.1" X 2.36" X 1.4"

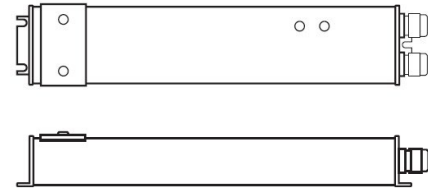

#### LUTRON 1%

3-WIRE DIMMING

L3DA4U1UKL-CV240	CLASS 2	4.89" X 4" X 2.62"
------------------	---------	--------------------

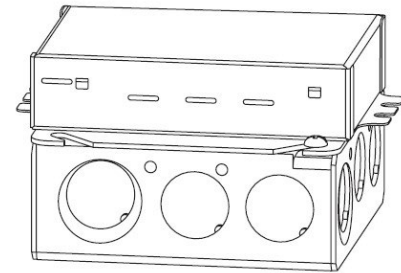

PSDE-96W-24V-ECO	CLASS 2	10.5" X 3.0" X 2.0"
------------------	---------	---------------------

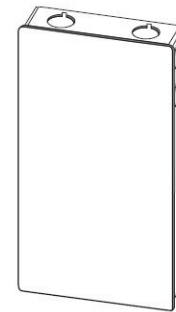

### COMPATIBLE NON-DIMMING DRIVERS

#### PSHK SERIES

NON-DIMMING CONSTANT VOLTAGE WITH JUNCTION BOX

PSHK-30W-24V	CLASS 2	6.5" X 3.6" X 1.02"
PSHK-60W-24V	CLASS 2	7.4" X 3.62" X 1.02"
PSHK-96W-24V	CLASS 2	8.66" X 3.66" X 1.61"
PSHK-150W-24V		10.24" X 4.06" X 1.81"
PSHK-200W-24V		10.24" X 4.06" X 1.81"
PSHK-288W-24V	CLASS 2	11.85" X 4.25" X 1.82"
PSHK-300W-24V		10.24" X 4.25" X 1.81"

