

# LFO-60

## 6W INDOOR/ OUTDOOR LINEAR OPTICAL LED STRIP

Project \_\_\_\_\_

Location \_\_\_\_\_

Quote/ Ref # \_\_\_\_\_

**LFO-60** is an indoor and outdoor flexible LED Strip that features the smallest, most discreet optical linear design. Easy to mount and install to nearly any surface and easily adaptable to almost any indoor or outdoor application. Its miniature optics are ideal for grazing, wall washing, cove and other architectural or accent lighting applications. Its silicone encapsulation makes it durable to withstand harsh elements. Available in different color temperatures and field cuttable.



### SPECIFICATIONS

INPUT VOLTAGE	24V DC
POWER CONSUMPTION	6W per Ft.
LUMEN OUTPUT	510 Lumens per Ft.
NO. OF LEDS	14 LEDs per Ft.
BEAM ANGLE	10°/ 30°/ 60°/ 30°x50°/ Asymmetric
CRI	90+
COLOR TEMPERATURE	27K/ 30K/ 35K/ 40K/ 50K
DIMMING/ CONTROL	MLV, ELV, 0-10 and TRIAC
MAXIMUM RUN LENGTH	32 Ft.
FIELD CUTTABLE	Every 6.0 in (152.4mm)
IP RATING	IP67 Outdoor/ Wet Rated
LUMEN MAINTENANCE	50,000 Hrs.
CERTIFICATIONS	UL Listed
OPERATING TEMPERATURE	-22°F (-30°C) to +122°F (+50°C)

### FEATURES

- 6W per Ft
- 510 Lumens per Ft.
- 90+ CRI
- Flexible, silicone encapsulated
- Field Cuttable\*
- Dimmable
- UL Listed

\* Indoor installation only



MODEL	COLOR TEMP	LENGTH	OPTICS	VOLTAGE	POWER FEED	FEED LENGTH
LFO-60	<b>27K</b> 2700K	1'XX per Ft.	<b>10</b> 10°	<b>24</b> 24V DC	<b>IP67EF</b> End Feed	<b>HW3</b> 3 Ft. Power Feed
	<b>30K</b> 3000K		<b>30</b> 30°		<b>IP67SFL</b> Side Feed Left	<b>HW10</b> 10 Ft. Power Feed
	<b>35K</b> 3500K		<b>60</b> 60°		<b>IP67SFR</b> Side Feed Right	<b>HW15</b> 15 Ft. Power Feed
	<b>40K</b> 4000K		<b>3050</b> 30° x 50°			<b>HW25</b> 25 Ft. Power Feed
	<b>50K</b> 5000K		<b>ASY</b> Asymmetric			

\*1 = Custom length per FT. (cuttable every 6")

# LFO-60

## 6W INDOOR/ OUTDOOR LINEAR OPTICAL LED STRIP

### DIMENSIONS

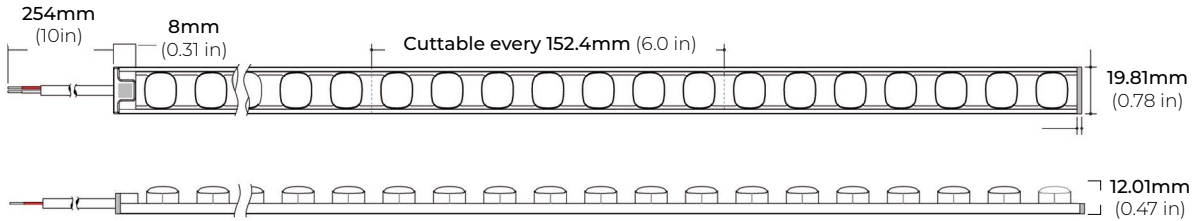

### ACCESSORIES

#### LFO-60-SDLV SYMMETRICAL LOUVER

\* Sold Separately per Ft.

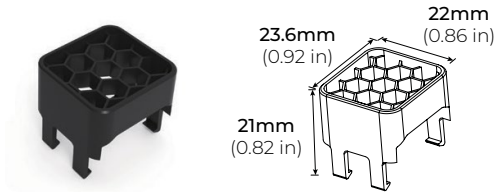

#### LFO-60-MB MOUNTING BRACKET 0.82" X 0.79" X 0.3"

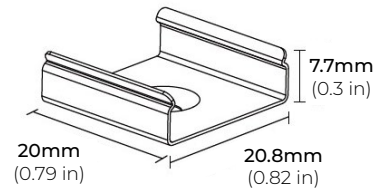

#### LFO-60-ASB ADJUSTABLE BRACKET

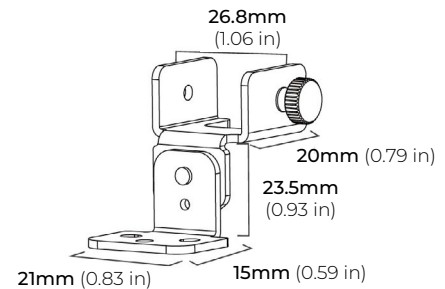

#### LFO-60-AC48 STANDARD ALUMINUM PROFILE 1.2" X 0.84" X 48"

\* Comes with clear lens

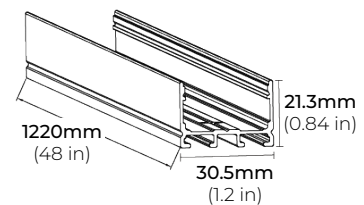

#### LFO-60-GS48 GLARE SHIELD ALUMINUM PROFILE 0.93" X 0.91" X 48"

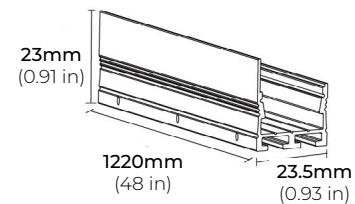

# LFO-60

## 6W INDOOR/ OUTDOOR LINEAR OPTICAL LED STRIP

### IP67 POWER FEED

IP67EF  
END FEED

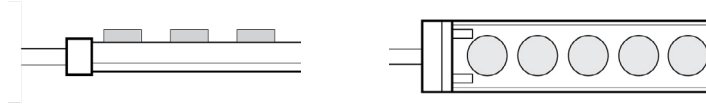

IP67SFL  
SIDE LEFT FEED

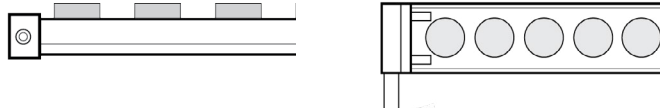

IP67SFR  
SIDE RIGHT FEED

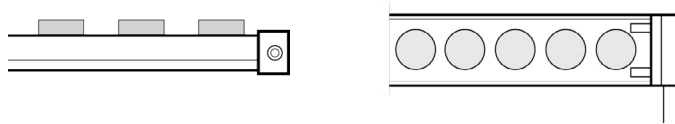

# LFO-60

## 6W INDOOR/ OUTDOOR LINEAR OPTICAL LED STRIP

### COMPATIBLE TRANSFORMERS

#### PSDL SERIES TRIAC DIMMABLE

PSDL-30W-24V	CLASS 2	6.5" X 3.63" X 1.03"
PSDL-60W-24V	CLASS 2	7.4" X 3.63" X 1.03"
PSDL-96W-24V	CLASS 2	8.67" X 3.67 X 1.62"
PSDL-150W-24V		8.67" X 3.67" X 1.62"
PSDL-192W-24V	CLASS 2	10.25" X 4.06" X 1.82"
PSDL-200W-24V		10.25" X 4.06" X 1.82"
PSDL-288W-24V	CLASS 2	10.25" X 4.06" X 1.82"
PSDL-300W-24V		10.25" X 4.06" X 1.82"

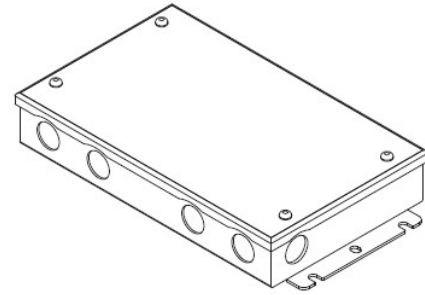

#### PSDH SERIES HIGH PERFORMANCE MAGNETIC LOW VOLTAGE (MLV)

PSDH-48W-24V	CLASS 2	11.25" X 3.37" X 3.25"
PSDH-96W-24V	CLASS 2	11.25" X 3.37" X 3.25"
PSDH-288W-24V	CLASS 2	14.25" X 8.43" X 4.43"

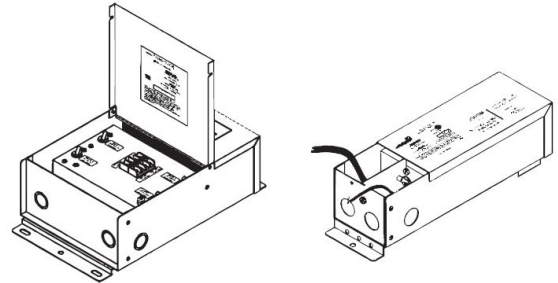

#### PSRX SERIES 0-10V DIMMING DRIVER

PSRX-30W-24V	CLASS 2	6.5" X 3.72" X 1.57"
PSRX-60W-24V	CLASS 2	7.4" X 3.72" X 1.57"
PSRX-96W-24V	CLASS 2	8.66" X 3.72" X 1.57"
PSRX-150W-24V		10.24" X 4.13" X 1.77"
PSRX-192W-24V	CLASS 2	11" X 4" X 1.82"
PSRX-200W-24V		10.24" X 4.13" X 1.77"
PSRX-288W-24V	CLASS 2	11.85" X 4.25" X 1.82"
PSRX-300W-24V		10.94" X 4.33" X 1.77"

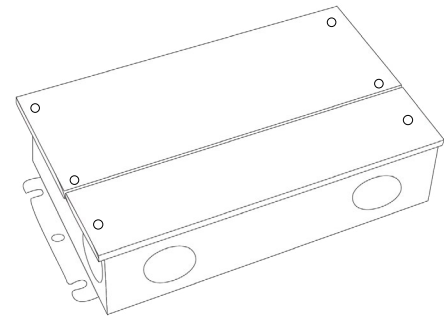

#### PSVT SERIES 4-IN-1 DIMMING DRIVER

PSVT-60W-24V	CLASS 2	7.4" X 3.72" X 1.57"
PSVT-96W-24V	CLASS 2	8.66" X 3.72" X 1.57"
PSVT-200W-24V		10.24" X 4.13" X 1.77"
PSVT-288W-24V	CLASS 2	11.85" X 4.25" X 1.81"
PSVT-300W-24V		10.94" X 4.33" X 1.77"

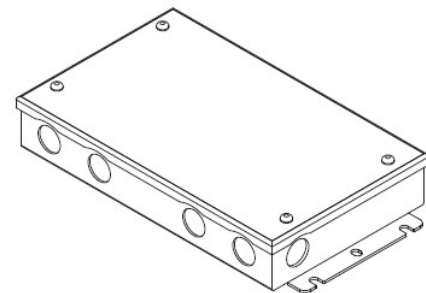

# LFO-60

## 6W INDOOR/ OUTDOOR LINEAR OPTICAL LED STRIP

### COMPATIBLE TRANSFORMERS

**PSDE SERIES**  
0-10V DIMMING W/ JUNCTION BOX

PSDE-60W-24V-010-JB    CLASS 2    12.1" X 2.36" X 1.4"  
PSDE-96W-24-010-JB    CLASS 2    12.1" X 2.36" X 1.4"

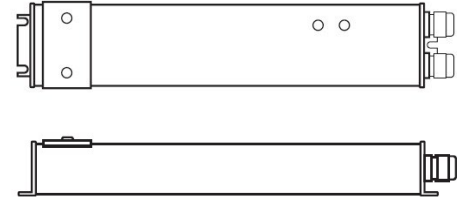

**LUTRON 1%**  
3-WIRE DIMMING

L3DA4U1UKL-CV240    CLASS 2    4.89" X 4" X 2.62"

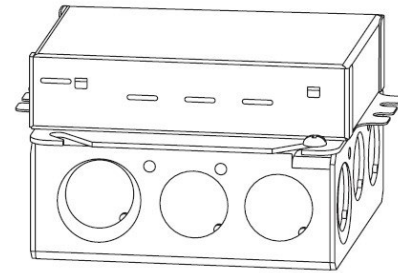

PSDE-96W-24V-ECO    CLASS 2    10.5" X 3.0" X 2.0"

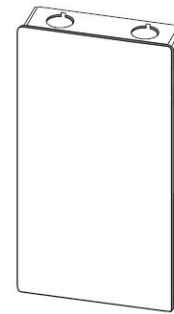

### COMPATIBLE NON-DIMMING DRIVERS

**PSHK SERIES**  
NON-DIMMING CONSTANT VOLTAGE WITH JUNCTION BOX

PSHK-30W-24V    CLASS 2    6.5" X 3.6" X 1.02"  
PSHK-60W-24V    CLASS 2    7.4" X 3.62" X 1.02"  
PSHK-96W-24V    CLASS 2    8.66" X 3.66" X 1.61"  
PSHK-150W-24V               10.24" X 4.06" X 1.81"  
PSHK-200W-24V               10.24" X 4.06" X 1.81"  
PSHK-288W-24V    CLASS 2    11.85" X 4.25" X 1.82"  
PSHK-300W-24V               10.24" X 4.25" X 1.81"

