

# LFO-50

## SYMMETRIC/ ASYMMETRIC FLEXIBLE WALL WASHER LED STRIP

Project \_\_\_\_\_  
Location \_\_\_\_\_  
Quote/ Ref # \_\_\_\_\_

**LFO-50 Series** is a surface mounted, architectural-grade flexible LED luminaire system designed for wall washing, grazing, cove and other accent applications. It can easily be mounted to nearly any surface, with customizable lengths in 6 inch increments. It is silicone encapsulated for durability & reliability making it suitable for indoor and outdoor applications.



### SPECIFICATIONS

INPUT VOLTAGE	24V DC
POWER CONSUMPTION	6W per Ft.
LUMEN OUTPUT	622 Lm (Symmetric) 513 Lm (Asymmetric)
NO. OF LEDs	14 LEDs per Ft. (Symmetric) 10 LEDs per Ft. (Asymmetric)
BEAM ANGLE	20°/ 30°/ 50°/ 25°x40°(Symmetric) 110°x70° (Asymmetric)
CRI	90+
COLOR TEMPERATURE	27K/ 30K/ 35K/ 40K/ 50K
DIMMING	MLV, ELV, 0-10 and TRIAC
MAXIMUM RUN LENGTH	16 Ft.
FIELD CUTTABLE	Every 6.56 in (166.6mm)
IP RATING	IP67 Wet Location (Outdoor)
LUMEN MAINTENANCE	50,000 Hrs.
CERTIFICATIONS	UL Listed, TITLE 24 JA8, ETL, RoHS
OPERATING TEMPERATURE	-40°F (-40°C) to +113°F (+45°C)

### FEATURES

- 6W per Ft
- 100 Lumens per Watt
- Maximum Run Length 16Ft.
- 90+ CRI
- California TITLE 24 JA8 Compliant
- High efficacy level
- Multiple CCT Options available
- Superior COLOR RENDERING INDEX (CRI)
- Dimmable with CORE Lighting dimmable drivers



MODEL	COLOR TEMP	OPTIC	LENGTH	VOLTAGE	POWER FEED	FEED LENGTH
LFO-50	<b>27K</b> 2700K	<b>20</b> 20°	<b>10</b> 10 Ft.	<b>24</b> 24V DC	<b>IP67EF</b> End Feed	<b>HW3</b> 3 Ft. Power Feed
	<b>30K</b> 3000K	<b>30</b> 30°	<b>1XX</b> per Ft.		<b>IP67SFL</b> Side Feed Left	<b>HW10</b> 10 Ft. Power Feed
	<b>35K</b> 3500K	<b>50</b> 50°			<b>IP67SFR</b> Side Feed Right	<b>HW15</b> 15 Ft. Power Feed
	<b>40K</b> 4000K	<b>2540</b> 25° x 40°				<b>HW25</b> 25 Ft. Power Feed
	<b>50K</b> 5000K	<b>11070</b> 110° x 70° (Asymmetric)				

\*1 = Custom length per FT. (cuttable every 6.56")

# LFO-50

## SYMMETRIC/ ASYMMETRIC FLEXIBLE WALL WASHER LED STRIP

### DIMENSIONS

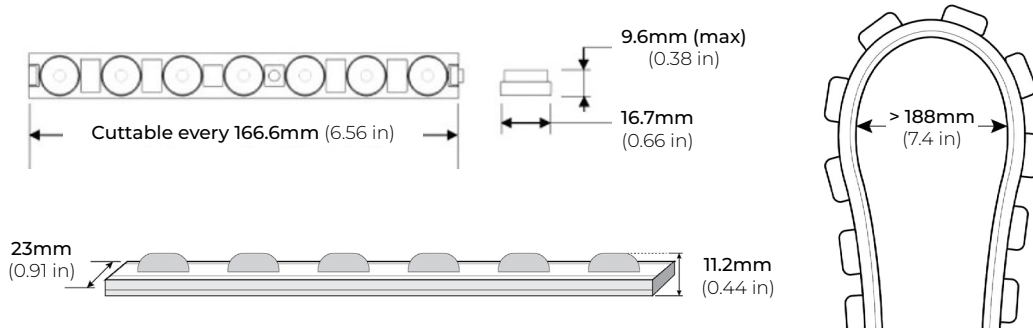

### OPTICS

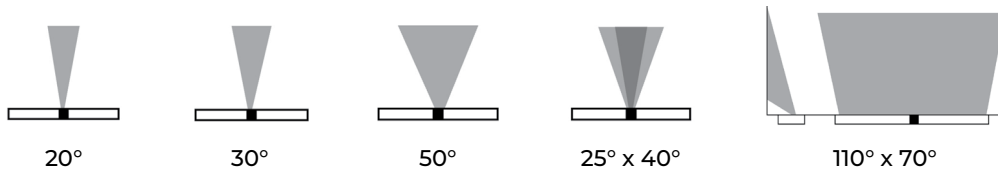

### ACCESSORIES

LFO-AC48  
LFO-AC96  
ALUMINUM PROFILE

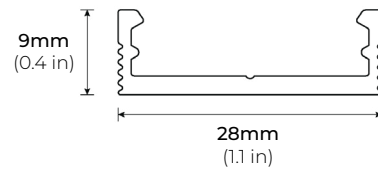

LFO-ASB  
ADJUSTABLE BRACKET

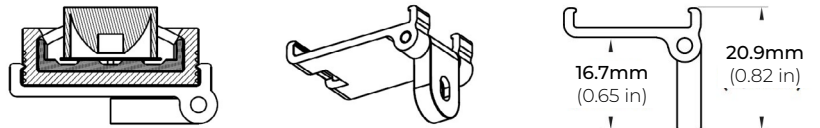

# LFO-50

## SYMMETRIC/ ASYMMETRIC FLEXIBLE WALL WASHER LED STRIP

### IP67 POWER FEED

---

IP67EF  
END FEED

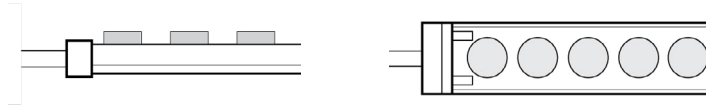

IP67SFL  
SIDE LEFT FEED

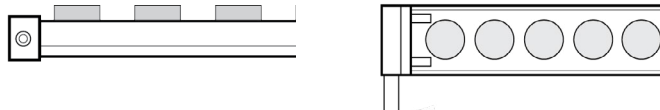

IP67SFR  
SIDE RIGHT FEED

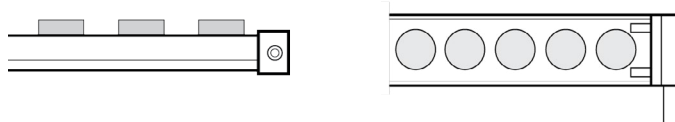

# LFO-50

## SYMMETRIC/ASYMMETRIC FLEXIBLE WALL WASHER LED STRIP

### COMPATIBLE TRANSFORMERS

#### PSDL SERIES TRIAC DIMMABLE

PSDL-30W-24V	CLASS 2	6.5" X 3.63" X 1.03"
PSDL-60W-24V	CLASS 2	7.4" X 3.63" X 1.03"
PSDL-96W-24V	CLASS 2	8.67" X 3.67 X 1.62"
PSDL-150W-24V		8.67" X 3.67" X 1.62"
PSDL-192W-24V	CLASS 2	10.25" X 4.06" X 1.82"
PSDL-200W-24V		10.25" X 4.06" X 1.82"
PSDL-288W-24V	CLASS 2	10.25" X 4.06" X 1.82"
PSDL-300W-24V		10.25" X 4.06" X 1.82"

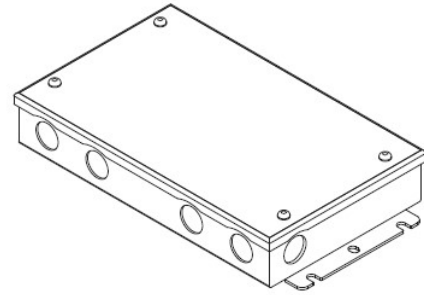

#### PSDH SERIES HIGH PERFORMANCE MAGNETIC LOW VOLTAGE (MLV)

PSDH-48W-24V	CLASS 2	11.25" X 3.37" X 3.25"
PSDH-96W-24V	CLASS 2	11.25" X 3.37" X 3.25"
PSDH-288W-24V	CLASS 2	14.25" X 8.43" X 4.43"

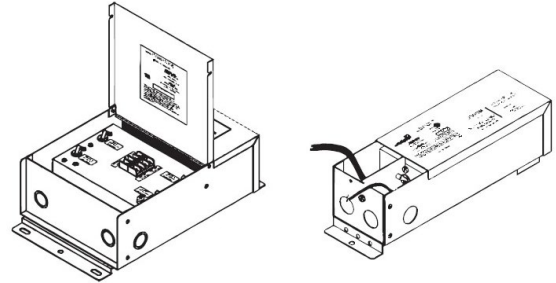

#### PSRX SERIES 4-IN-1 DIMMING DRIVER

PSRX-30W-24V	CLASS 2	6.5" X 3.72" X 1.57"
PSRX-60W-24V	CLASS 2	7.4" X 3.72" X 1.57"
PSRX-96W-24V	CLASS 2	8.66" X 3.72" X 1.57"
PSRX-150W-24V		10.24" X 4.13" X 1.77"
PSRX-192W-24V	CLASS 2	11" X 4" X 1.82"
PSRX-200W-24V		10.24" X 4.13" X 1.77"
PSRX-288W-24V	CLASS 2	11.85" X 4.25" X 1.82"
PSRX-300W-24V		10.94" X 4.33" X 1.77"

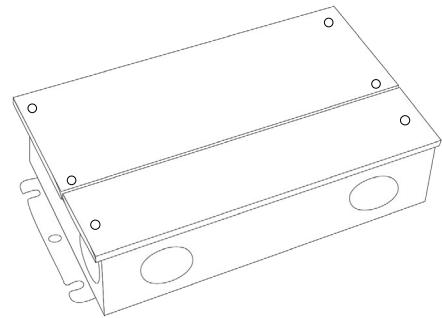

#### PSVT SERIES 0-10V DIMMING DRIVER

PSVT-60W-24V	CLASS 2	7.4" X 3.72" X 1.57"
PSVT-96W-24V	CLASS 2	8.66" X 3.72" X 1.57"
PSVT-200W-24V		10.24" X 4.13" X 1.77"
PSVT-288W-24V	CLASS 2	11.85" X 4.25" X 1.81"
PSVT-300W-24V		10.94" X 4.33" X 1.77"

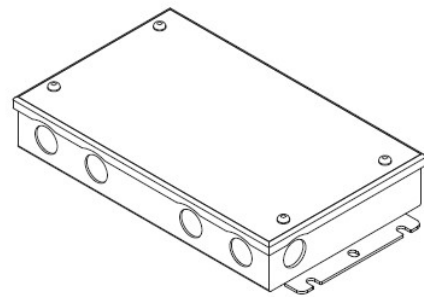

# LFO-50

## SYMMETRIC/ ASYMMETRIC FLEXIBLE WALL WASHER LED STRIP

### COMPATIBLE TRANSFORMERS

#### PSDE SERIES

0-10V DIMMING W/ JUNCTION BOX

PSDE-60W-24V-010-JB CLASS 2 12.1" X 2.36" X 1.4"

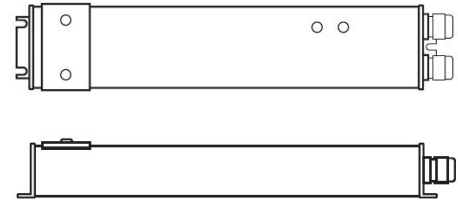

#### LUTRON 1%

3-WIRE DIMMING

L3DA4U1UKL-CV240 CLASS 2 4.0" X 1.5" X 4.0"

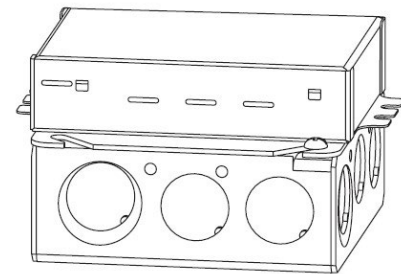

#### LUTRON 1%

PSDE-96W-24V-ECO CLASS 2 10.5" X 3.0" X 2.0"

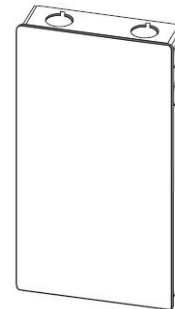

### COMPATIBLE NON-DIMMING DRIVERS

#### PSHK SERIES

NON-DIMMING CONSTANT VOLTAGE WITH JUNCTION BOX

PSHK-30W-24V	CLASS 2	6.5" X 3.6" X 1.02"
PSHK-60W-24V	CLASS 2	7.4" X 3.62" X 1.02"
PSHK-96W-24V	CLASS 2	8.66" X 3.66" X 1.61"
PSHK-150W-24V		10.24" X 4.06" X 1.81"
PSHK-200W-24V		10.24" X 4.06" X 1.81"
PSHK-288W-24V	CLASS 2	11.85" X 4.25" X 1.82"
PSHK-300W-24V		10.24" X 4.25" X 1.81"

