

SLINQ

FLEXIBLE 360° ROUND NEON SERIES

Project _____

Location _____

Quote/ Ref # _____

Set your creativity free and unleash the endless possibilities. Different mounting options allow for pendants, suspended mounts, flush mounts, arches and free form designs. The 360° light source gives illumination no matter how the fixture is mounted. Discover what you can create with the **SLINQ** Neon Series.

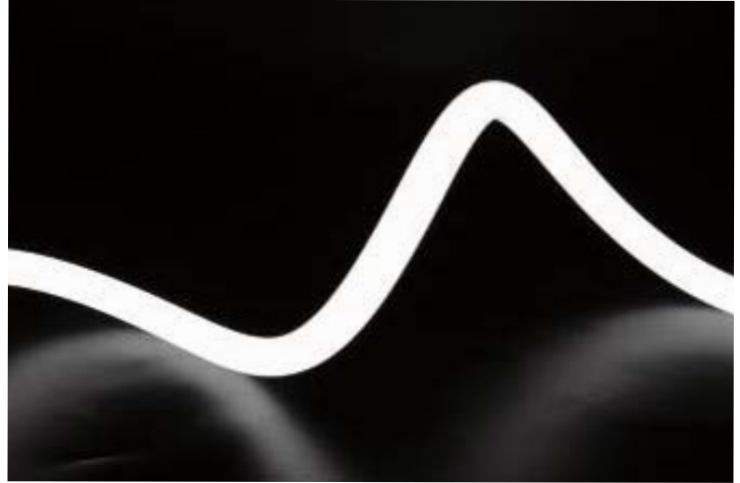

SPECIFICATIONS

| | |
|-----------------------|------------------------------|
| POWER CONSUMPTION | 4.4W per foot |
| LUMEN OUTPUT | 317 Lm/ Ft. (30K) |
| CRI | 90+ |
| COLOR TEMPERATURE | 24K/ 27K/ 30K/ 35K/ 40K/ 50K |
| MAXIMUM RUN LENGTH | 16 Ft. (24V)/ 40 Ft. (48V) |
| OPERATING VOLTAGE | 24V/ 48V |
| STORAGE TEMPERATURE | -30°C to 60°C |
| OPERATING TEMPERATURE | 30°C (-22°F) to 55°C (131°F) |
| BEAM ANGLE | 360° |
| IP RATING | IP65 Outdoor/ Wet Location |
| LUMEN MAINTENANCE | 50,000 Hrs. |

FEATURES

- 360° Light Source
- Multiple Mounting Options
- Universal Dimming
- Available in 24V and 48V DC
- IP65 Outdoor Rated
- Factory-Installed Power Feed
- Injection Moulded End-Caps
- Ideal for Decorative, Retail, Artistic Lighting



| MODEL | LENGTH | COLOR TEMP | VOLTAGE | MOUNTING OPTIONS | POWER FEED |
|--------|----------------------|---------------------|------------------------|--|--|
| SLQ-25 | Per Inch Per Inch | 24K 2400K | 24V 24 Volts | AR Arch | EF72 72" End Feed |
| | | 27K 2700K | 48V 48 Volts | SF Surface Pendant | SF72 72" Side Feed |
| | | 30K 3000K | | SUP Suspended Pendant | |
| | | 35K 3500K | | SCS Suspension Cable Support | |
| | | 40K 4000K | | SJS Suspension Joiner Support | |
| | | 50K 5000K | | TES Telescopic Extension Support | |
| | | | | TJS Telescopic Joiner Support | |
| | | | | | *MAX RUN: 24V - 16 Ft. 48V - 40 Ft. |

SLINQ

FLEXIBLE 360° ROUND NEON SERIES

MOUNTING OPTIONS

ARCH (AR)

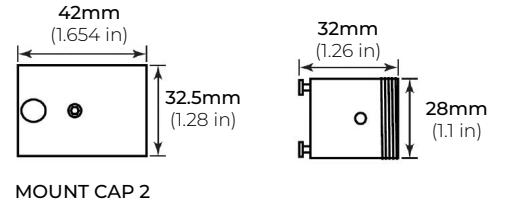
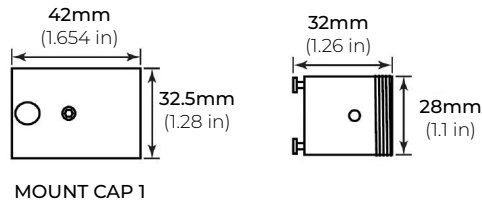
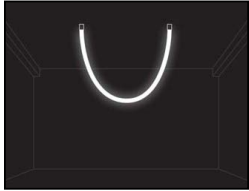

SURFACE PENDANT (SF)

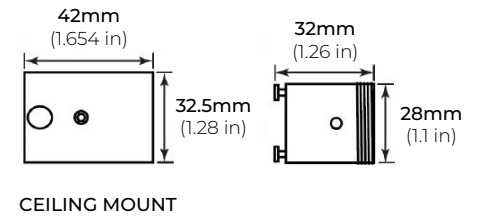
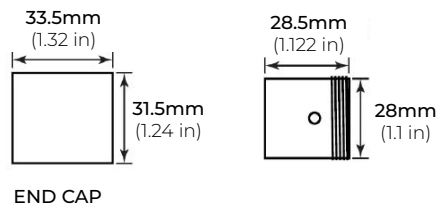
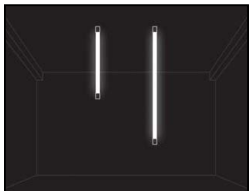

SUSPENDED PENDANT (SUP)

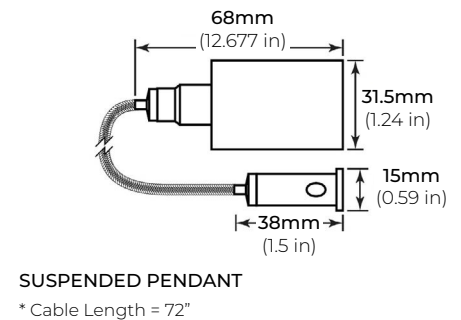
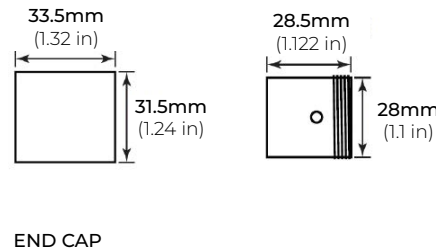
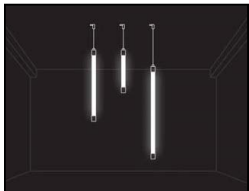

SUSPENSION CABLE SUPPORT (SCS)

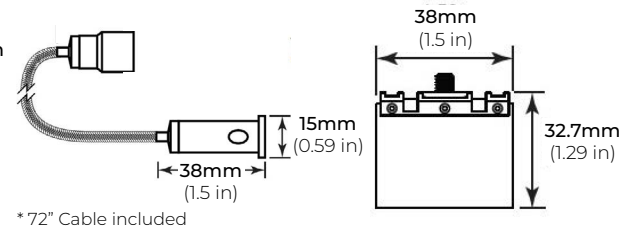
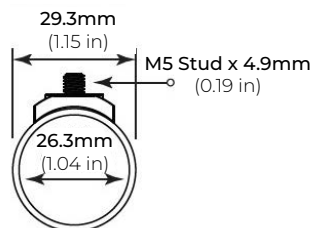
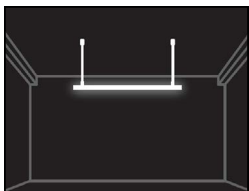

SLINQ

FLEXIBLE 360° ROUND NEON SERIES

MOUNTING OPTIONS

SUSPENSION JOINER SUPPORT (SJS)

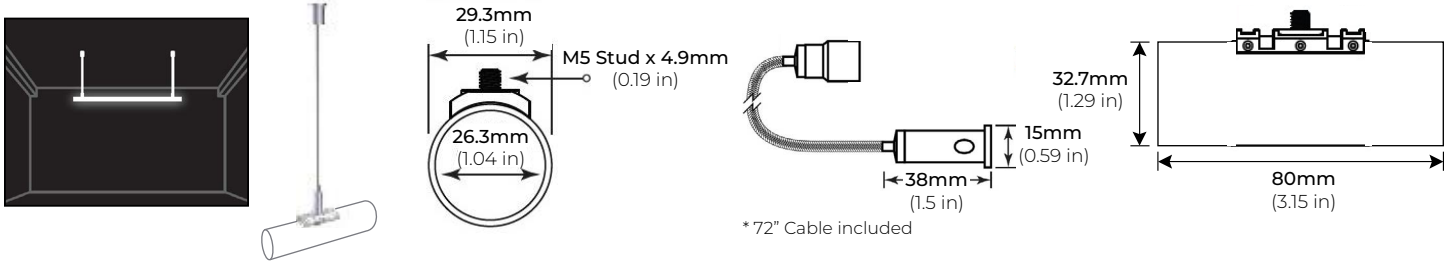

TELESCOPIC EXTENSION SUPPORT (TES)



TELESCOPIC JOINER SUPPORT (TJS)

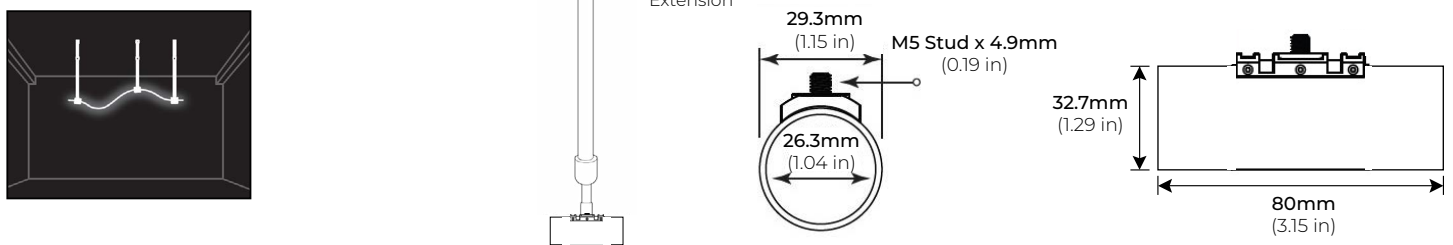

SLINQ

FLEXIBLE 360° ROUND NEON SERIES

ACCESSORIES

VISIBLE MOUNTING CLIP (VMC)

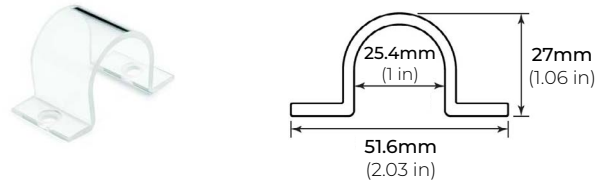

DISCREET MOUNTING BRACKET (DMB)

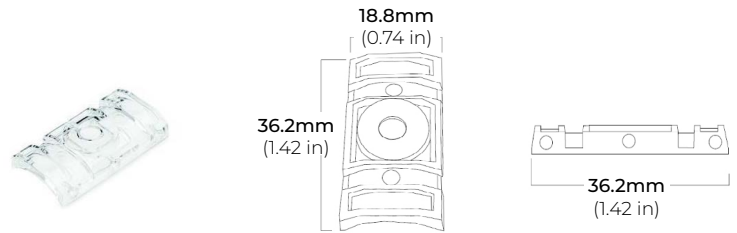

INFINITY JOINER (IJ)

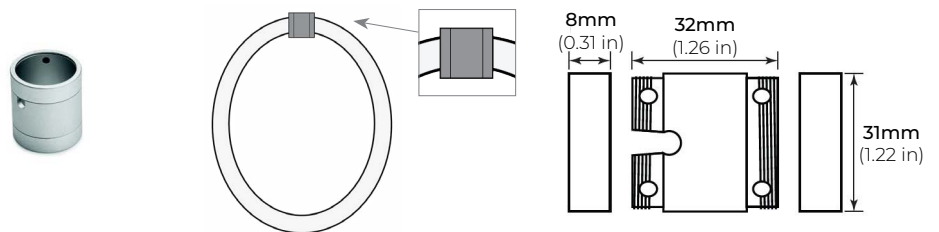

SLQ25-RTS-39-S
39" RIGID TUBE

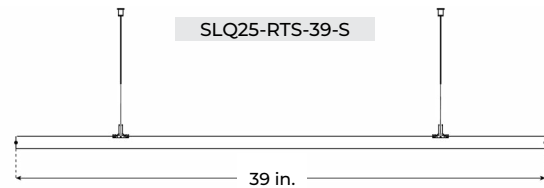

SLQ25-RTS-78-S
78" RIGID TUBE

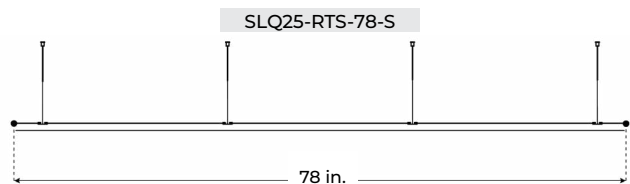

DIMENSIONS

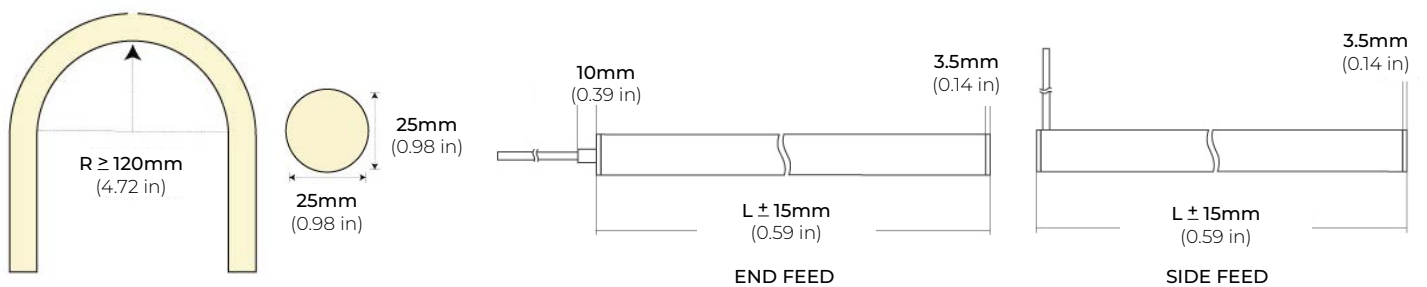

FLEXIBLE 360° ROUND NEON SERIES

COMPATIBLE 24V TRANSFORMERS

PSDL SERIES TRIAC DIMMABLE

| | | |
|---------------|---------|------------------------|
| PSDL-30W-24V | CLASS 2 | 6.5" X 3.63" X 1.58" |
| PSDL-60W-24V | CLASS 2 | 7.4" X 3.63" X 1.58" |
| PSDL-96W-24V | CLASS 2 | 8.67" X 3.67 X 1.62" |
| PSDL-150W-24V | | 10.25" X 4.06" X 1.82" |
| PSDL-192W-24V | CLASS 2 | 11" X 4" X 1.82" |
| PSDL-200W-24V | | 10.25" X 4.06" X 1.82" |
| PSDL-288W-24V | CLASS 2 | 11.85" X 4.25" X 1.82" |
| PSDL-300W-24V | | 10.25" X 4.06" X 1.82" |

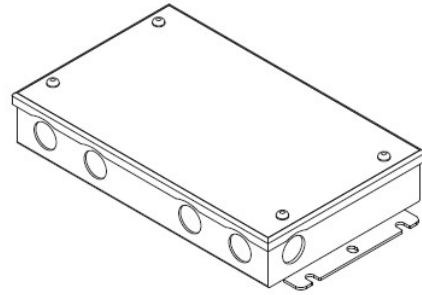

PSDH SERIES HIGH PERFORMANCE MAGNETIC LOW VOLTAGE (MLV)

| | | |
|---------------|---------|------------------------|
| PSDH-48W-24V | CLASS 2 | 11.25" X 3.38" X 3.38" |
| PSDH-96W-24V | CLASS 2 | 11.25" X 3.38" X 3.37" |
| PSDH-288W-24V | CLASS 2 | 14.25" X 8.43" X 4.43" |

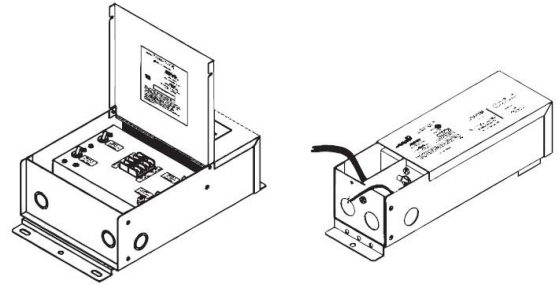

PSRX SERIES 4-IN-1 DIMMING DRIVER W/ JUNCTION BOX

| | | |
|-------------------|---------|------------------------|
| PSRX-30W-24V-UNV | CLASS 2 | 6.5" X 3.7" X 1.57" |
| PSRX-60W-24V-UNV | CLASS 2 | 7.4" X 3.72" X 1.57" |
| PSRX-96W-24V-UNV | CLASS 2 | 8.66" X 3.72" X 1.57" |
| PSRX-150W-24V-UNV | | 10.24" X 4.13" X 1.77" |
| PSRX-192W-24V-UNV | CLASS 2 | 11" X 4" X 1.82" |
| PSRX-200W-24V-UNV | | 10.24" X 4.13" X 1.77" |
| PSRX-288W-24V-UNV | CLASS 2 | 11.85" X 4.25" X 1.82" |
| PSRX-300W-24V-UNV | | 10.94" X 4.33" X 1.77" |

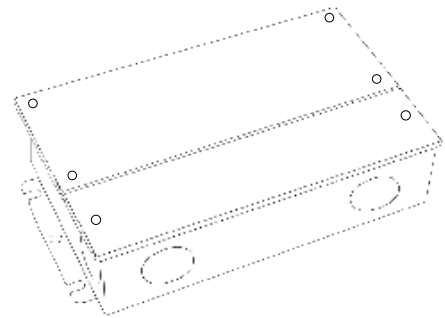

LUTRON 1% 3-WIRE DIMMING

| | | |
|------------------|---------|--------------------|
| L3DA4U1UKL-CV240 | CLASS 2 | 4.89" X 4" X 2.62" |
|------------------|---------|--------------------|

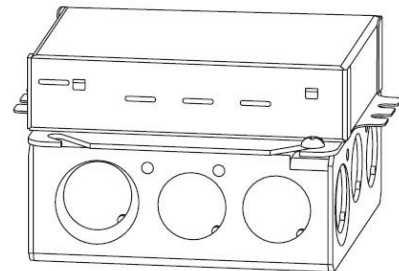

FLEXIBLE 360° ROUND NEON SERIES

COMPATIBLE 24V TRANSFORMERS

LUTRON 1%

PSDE-96W-24V-ECO CLASS 2 10.5" X 3.0" X 2.0"

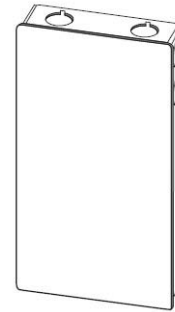

COMPATIBLE 24V NON-DIMMING DRIVERS

PSHK SERIES

NON-DIMMING CONSTANT VOLTAGE WITH JUNCTION BOX

| | | |
|---------------|---------|------------------------|
| PSHK-30W-24V | CLASS 2 | 6.5" X 3.6" X 1.02" |
| PSHK-60W-24V | CLASS 2 | 7.4" X 3.62" X 1.02" |
| PSHK-96W-24V | CLASS 2 | 8.66" X 3.66" X 1.61" |
| PSHK-150W-24V | | 10.24" X 4.06" X 1.81" |
| PSHK-200W-24V | | 10.24" X 4.06" X 1.81" |
| PSHK-288W-24V | CLASS 2 | 11.85" X 4.25" X 1.82" |
| PSHK-300W-24V | | 10.24" X 4.25" X 1.81" |

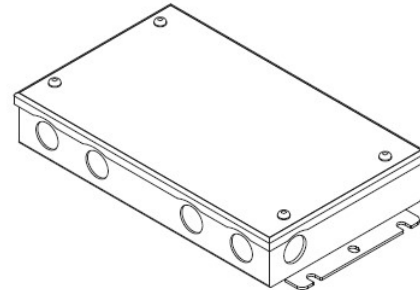

COMPATIBLE 48V TRANSFORMERS

PSRX SERIES

4-IN-1 DIMMING DRIVER W/ JUNCTION BOX

| | |
|-------------------|------------------------|
| PSRX-200W-48V-UNV | 10.24" X 4.13" X 1.77" |
| PSRX-300W-48V-UNV | 10.24" X 4.13" X 1.77" |

