

LWW120-VHO

120V-277V HIGH-OUTPUT LED WALL WASHER

UPDATED: 12.04.24

Project _____

Location _____

Quote/ Ref # _____

LWW120-VHO Linear Wall washer series is a powerful 120V LED flood light typically used for building facades, signs or any wall washing application Available in multiple optical lens options to provide endless lighting solutions.



SPECIFICATIONS

INPUT VOLTAGE	120-277 AC
POWER CONSUMPTION	15W
LUMENS PER WATT	100 Lm/W (30K)
COLOR TEMPERATURE	27K/ 30K/ 35K/ 40K/ 50K/ 60K
BEAM ANGLE	10°/ 20°/ 25°/ 35°/ 50°/ 10°x60
MAX RUN	Linkable up to 17 Fixtures
CRI	90+
DIMMING	0-10V and DALI-2
OPERATING TEMPERATURE	-40°F (-40°C) to 122°F (50°C)
STORAGE TEMPERATURE	-40°F (-40°C) to 185°F (85°C)
HOUSING	6063 Aluminum Alloy
IP RATING	IP66 Outdoor/ Wet Location
CERTIFICATIONS	ETL Listed, CE
LUMEN MAINTENANCE	> 70,000 Hrs.
WARRANTY	5-Year Limited

FEATURES

- 90+ CRI
- Multiple beam angles
- Multiple CCT options available
- ETL Listed



MODEL	WATT	CCT	OPTICS	MOUNT	FINISH	DIM	VOLT	OPTIONAL ACCESSORIES
LWW120-VHO	24 23.6 in (30W)	27K 2700K	10 10°	STB Standard Tilting Bracket	GR Gray	010 0-10V	UNV 120V-277V	ADLV Asymmetric Anti-Glare Louver
	36 35.4 in (45W)	30K 3000K	20 20°	ETB Extended Tilting Bracket	BK Black	DALI DALI		SDLV Symmetric Anti-Glare Louver
	48 47.2 in (60W)	35K 3500K	25 25°	STK Mounting Stake	WH White			GS Glare Shield
		40K 4000K	35 35°	SWM Small Wall Mount				
		50K 5000K	50 50°	LWM Large Wall Mount				
		60K 6000K	1060 10°x60°					

LWW120-VHO

120V-277V HIGH-OUTPUT LED WALL WASHER

DIMENSIONS

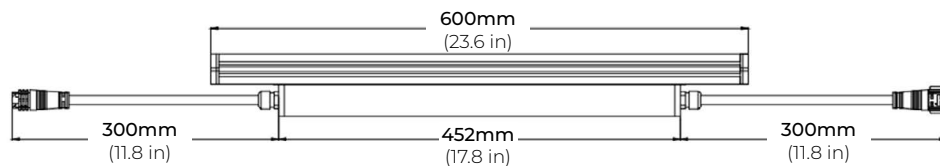
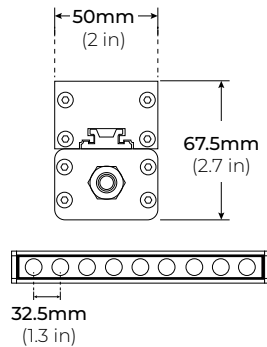

LWW120-VHO-24

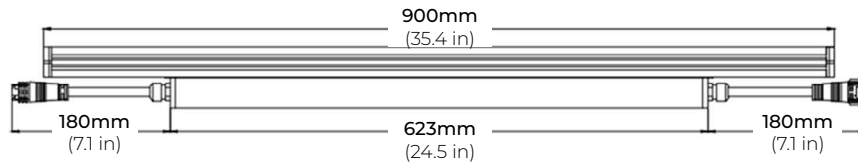

LWW120-VHO-36

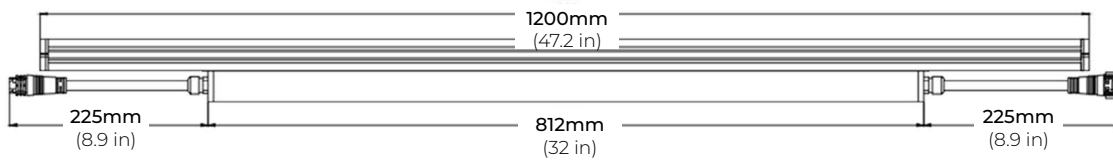

LWW120-VHO-48

LWW120-VHO

120V-277V HIGH-OUTPUT LED WALL WASHER

OPTICS

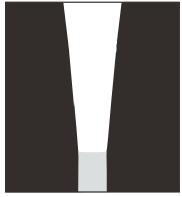

10°

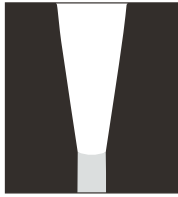

20°

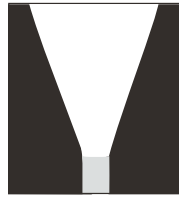

25°

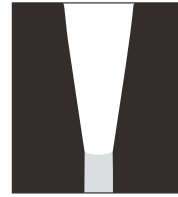

35°

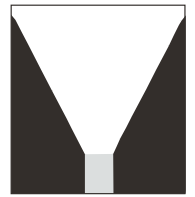

50°

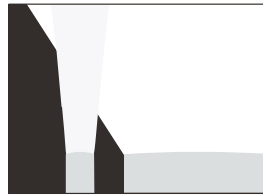

10° x 60°

MOUNTING ACCESSORIES

LWW120-VHO-STB
STANDARD TILTING BRACKET
*Included with every Fixture

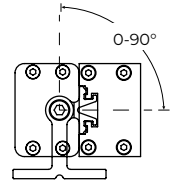
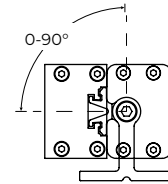
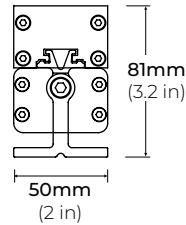

LWW120-VHO-ETB
EXTENDED TILTING BRACKET
*Sold Separately

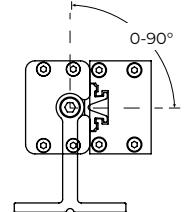
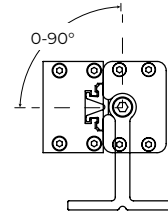
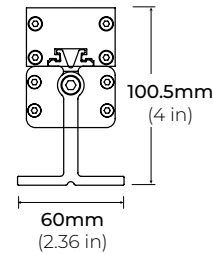

LWW120-VHO-STK
MOUNTING STAKE
*Sold Separately

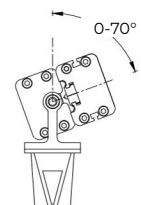
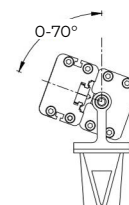
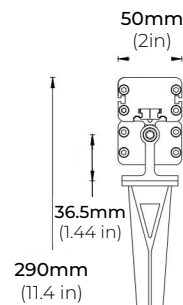

LWW120-VHO

120V-277V HIGH-OUTPUT LED WALL WASHER

MOUNTING ACCESSORIES

LWW120-VHO-SWM
SMALL WALL MOUNT (6-9")
*Sold Separately

LWW120-VHO-LWM
LARGE WALL MOUNT (14-22")
*Sold Separately

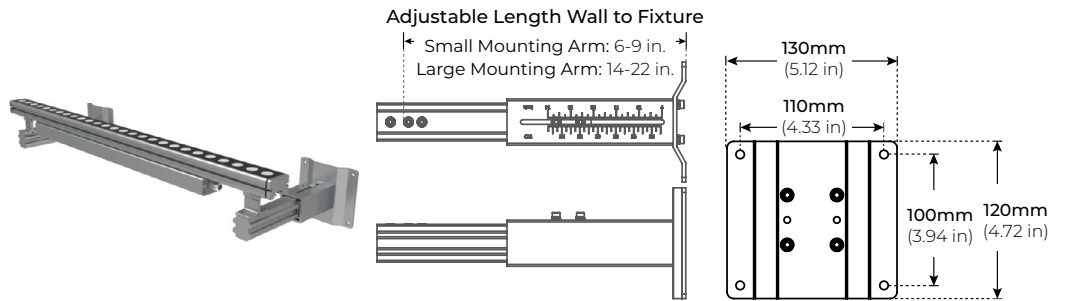

COMPATIBLE ACCESSORIES

LWW-EC
END CAP
*Sold Separately

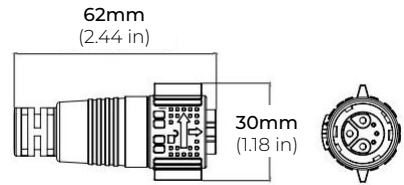

LWW120-VHO-12-ADLV
LWW120-VHO-24-ADLV
LWW120-VHO-36-ADLV
LWW120-VHO-48-ADLV
12", 24", 36", 48" ASYMMETRIC LOUVER
*Sold Separately



LWW120-VHO-12-SDLV
LWW120-VHO-24-SDLV
LWW120-VHO-36-SDLV
LWW120-VHO-48-SDLV
12", 24", 36", 48" SYMMETRIC LOUVER
*Sold Separately

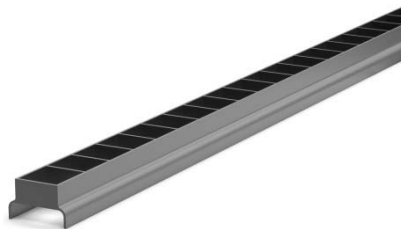

LWW120-VHO-GS
GLARE SHIELD

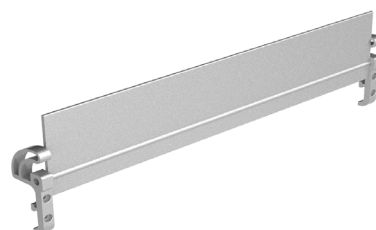

LWW120-VHO

120V-277V HIGH-OUTPUT LED WALL WASHER

COMPATIBLE ACCESSORIES

LWW120-LNK-10
LWW120-LNK-36
LWW120-LNK-72
10", 36", 72" LINK EXTENSION CABLE
*Sold Separately



LWW120-HWC-72
LWW120-HWC-120
72" AND 120" HARDWIRE CABLE
*Sold Separately

