

# LWW-MN

## HIGH-OUTPUT MINI LED WALL WASHER

Project \_\_\_\_\_  
Location \_\_\_\_\_  
Quote/ Ref # \_\_\_\_\_

**LWW-MN** Linear Wall washer series is a powerful LED flood light typically used for building facades, signs or any wall washing applications. Variety of optical lens options provides endless lighting solutions. Available in narrow, medium, wide and elliptical optic options.



### SPECIFICATIONS

INPUT VOLTAGE	24V DC
OPERATING VOLTAGE	100V-277V AC
OPERATING FREQUENCY	50/ 60 Hz
POWER CONSUMPTION	6W/ Ft.
LUMEN OUTPUT	110 Lm/W
CRI	90+
COLOR TEMPERATURE	27K / 30K / 35K / 40K / 50K / 60K RD / GN / BL / AM
DIMMING	0-10V
MAX RUN	Linkable up to 20 ft.
OPERATING TEMPERATURE	-40°F TO 185°F (-40°C TO 85°C)
STORAGE TEMPERATURE	-40°F TO 122°F (-40°C TO 50°C)
BEAM ANGLE	20° / 40° / 60° / 20°x40°
IP RATING	IP66 wet location (outdoor)
LUMEN MAINTENANCE	50,000 Hrs.

### FEATURES

- 90+ CRI
- 110 Lumens per Watt
- Linkable up to 20Ft.
- Proprietary Optical Technology
- TRIAC Dimming
- Proprietary Adjustable Mounting Bracket
- Facade Wall Washing
- Graze Lighting
- Signage



MODEL	LENGTH	COLOR TEMP		OPTICS	OPTIONS	VOLTAGE
LWWMN	20 20" (9W)	27K	RD Red	20 20°	FMB Fixed Mounting Bracket	24 24V DC
		30K	GN Green	40 40°	STB Standard Tilting Bracket	
	35K	BL Blue	60 60°	ETB Extended Tilting Bracket		
	40K	AM Amber	20x40 20° x 40°	STK Mounting Stake		
	50K	5000K				
	40 40" (18W)	60K	6000K			

# LWW-MN

## HIGH-OUTPUT MINI LED WALL WASHER

### DIMENSIONS

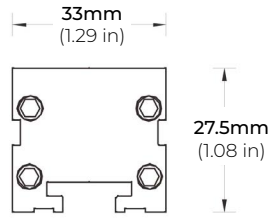

### OPTICS

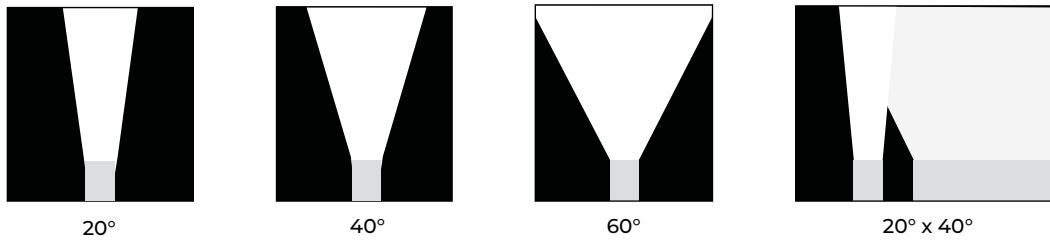

### MOUNTING ACCESSORIES

**LWW-MN-FMB**  
FIXED MOUNTING BRACKET  
\*Sold Separately

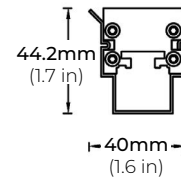

**LWW-MN-STB**  
STANDARD TILTING BRACKET  
\*Included with every Fixture

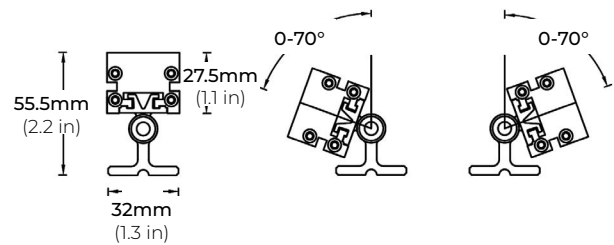

**LWW-MN-ETB**  
EXTENDED TILTING BRACKET  
\*Sold Separately

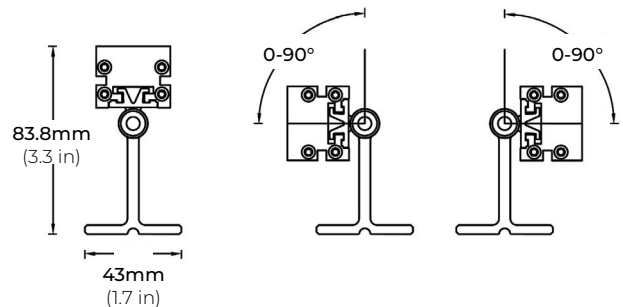

# LWW-MN

## HIGH-OUTPUT MINI LED WALL WASHER

### MOUNTING ACCESSORIES

LWW-MN-STK  
MOUNTING STAKE

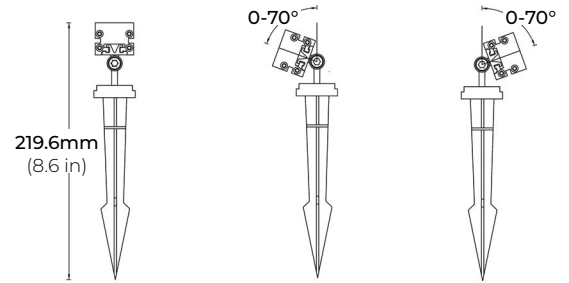

### COMPATIBLE ACCESSORIES

LWW-EC  
END CAP  
\*Sold Separately

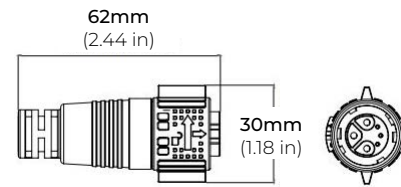

LWW-MN-12-ADLV  
LWW-MN-24-ADLV  
LWW-MN-36-ADLV  
LWW-MN-48-ADLV  
12", 24", 36", 48" ASYMMETRIC LOUVER  
\*Sold Separately

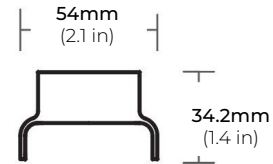
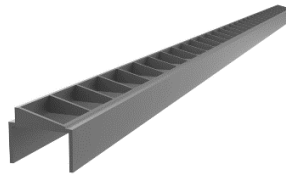

LWW-MN-12-SDLV  
LWW-MN-24-SDLV  
LWW-MN-36-SDLV  
LWW-MN-48-SDLV  
12", 24", 36", 48" SYMMETRIC LOUVER  
\*Sold Separately

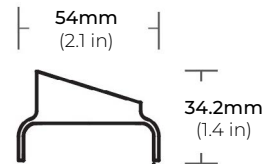
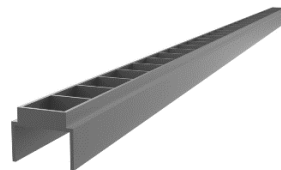

LWW-MN-LNK-10  
LWW-MN-LNK-36  
LWW-MN-LNK-72  
10", 36", 72" LINK EXTENSION CABLE  
\*Sold Separately



LWW-MN-HWC-72-BK  
72" HARDWIRE CABLE  
\*Sold Separately



## HIGH-OUTPUT MINI LED WALL WASHER

### COMPATIBLE TRANSFORMERS

#### PSDE SERIES

0-10V DIMMING W/ JUNCTION BOX

PSDE-60W-24V-010-JB	CLASS 2	12.1" X 2.36" X 1.4"
PSDE-96W-24V-010-JB	CLASS 2	12.1" X 2.36" X 1.4"

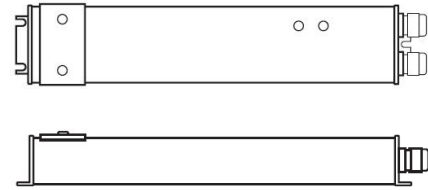

#### PSRX SERIES

4-IN-1 DIMMING DRIVER

PSRX-30W-24V	CLASS 2	6.5" X 3.72" X 1.57"
PSRX-60W-24V	CLASS 2	7.4" X 3.72" X 1.57"
PSRX-96W-24V	CLASS 2	8.66" X 3.72" X 1.57"
PSRX-150W-24V		10.24" X 4.13" X 1.77"
PSRX-192W-24V	CLASS 2	11" X 4" X 1.82"
PSRX-200W-24V		10.24" X 4.13" X 1.77"
PSRX-288W-24V	CLASS 2	11.85" X 4.25" X 1.82"
PSRX-300W-24V		10.94" X 4.33" X 1.77"

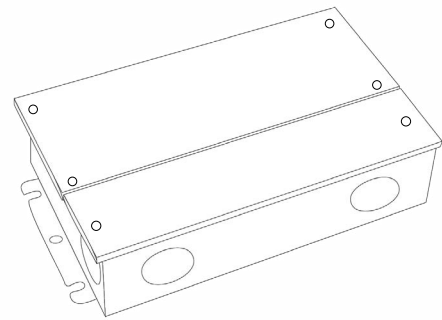

#### PSVT SERIES

0-10V DIMMING DRIVER

PSVT-60W-24V	CLASS 2	7.4" X 3.72" X 1.57"
PSVT-96W-24V	CLASS 2	8.66" X 3.72" X 1.57"
PSVT-200W-24V		10.24" X 4.13" X 1.77"
PSVT-288W-24V	CLASS 2	11.85" X 4.25" X 1.81"
PSVT-300W-24V		10.94" X 4.33" X 1.77"

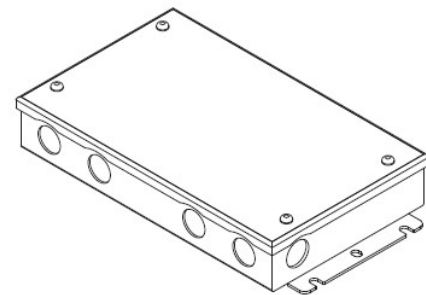

### COMPATIBLE NON-DIMMING DRIVERS

#### PSHK SERIES

NON-DIMMING CONSTANT VOLTAGE WITH JUNCTION BOX

PSHK-30W-24V	CLASS 2	6.5" X 3.6" X 1.02"
PSHK-60W-24V	CLASS 2	7.4" X 3.62" X 1.02"
PSHK-96W-24V	CLASS 2	8.66" X 3.66" X 1.61"
PSHK-150W-24V		10.24" X 4.06" X 1.81"
PSHK-200W-24V		10.24" X 4.06" X 1.81"
PSHK-288W-24V	CLASS 2	11.85" X 4.25" X 1.82"
PSHK-300W-24V		10.24" X 4.25" X 1.81"

