

LSPW-80 RGB+W

8.8W OUTDOOR COLOR CHANGING + WHITE LED STRIP

Project _____
Location _____
Quote/ Ref # _____

LSPW-80 RGBW is an outdoor/ wet rated color-changing + white LED strip that provides a full spectrum of color changing schemes. The warm or cool white LED's combined with the full color spectrum of the RGB light array produces more powerful color options that's sure to please even the most discerning lighting designer. Suitable for residential, commercial, hospitality and architectural lighting applications.

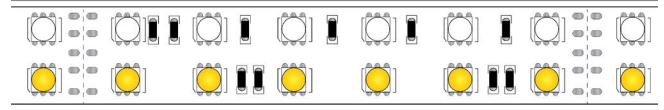

SPECIFICATIONS

INPUT VOLTAGE	24V DC
POWER CONSUMPTION	8.8W <i>(4.4W—38Lm/W RGB 4.4W — 86Lm/W White)</i>
LEDS/ FT.	36 LEDS/Ft.
LUMEN OUTPUT	475 Lm/Ft. <i>(RGB+3000K)</i>
CRI	90+
COLOR TEMPERATURE	RGB+27K / RGB+30K / RGB+40K / RGB+50K
DIMMING	Through RGBW Controller
MAXIMUM RUN LENGTH	24 Ft.
CUTTABLE	Every 3.94 in. (100mm)
OPERATING TEMPERATURE	-40°F (-40°C) to 140°F (60°C)
BEAM ANGLE	120°
IP RATING	IP65 outdoor, wet location
CERTIFICATIONS	UL Listed, TITLE 24 JA8
LUMEN MAINTENANCE	50,000 Hrs.

FEATURES

- 8.8W/Ft.
- 145 Lm./Ft. (RGB) | 380 Lm./Ft. (White)
- 90+ CRI
- Two rows of high-output diodes
- Field Cuttable
- IP65 Outdoor / Wet Rated
- UL Listed
- California TITLE 24 JA8 Compliant



MODEL	COLOR TEMP	LENGTH	VOLTAGE	PROFILE
LSPW-80	RGBW27K RGB + 2700K	16 16 Ft.	24 24V DC	See Page 2 for compatible profiles.
	RGBW30K RGB + 3000K	32 32 Ft.		
	RGBW40K RGB + 4000K	PF Per Ft.		
	RGBW50K RGB + 5000K			

* Custom color finishes require powder coating. Allow 7 days leads time.

LSPW-80 RGB+W

8.8W OUTDOOR COLOR CHANGING + WHITE LED STRIP

DIMENSIONS

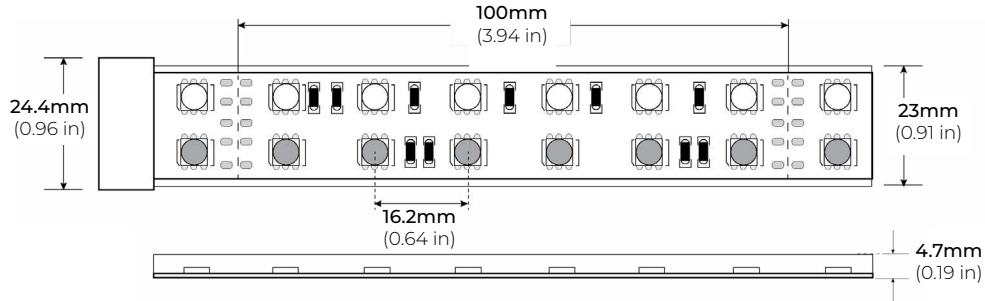

COMPATIBLE ALUMINUM PROFILES

SURFACE PROFILES

ALP-140

LENGTHS 48" | 98"
LENS Frosted
FINISH Silver

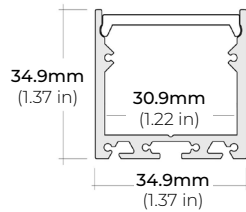

ALP-150LX

LENGTHS 49" | 98"
LENS Frosted
FINISH White | Black

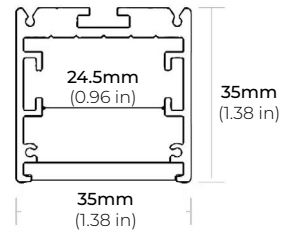

ALP-160

LENGTHS 49" | 98"
LENS Frosted
FINISH Silver

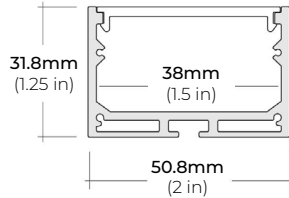

ALP-190

LENGTHS 48" | 98"
LENS Frosted
FINISH Silver

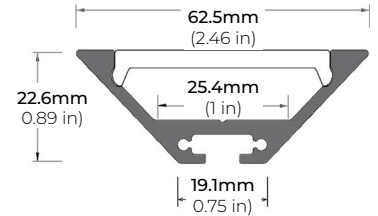

ALP-230N

LENGTHS 49" | 98"
LENS Frosted
FINISH Silver

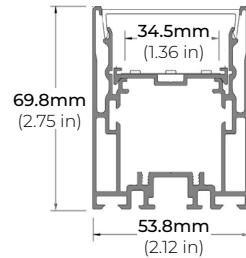

ALP-310N

LENGTHS 49" | 98"
LENS Frosted
FINISH Silver

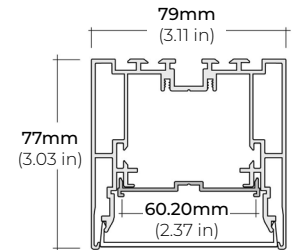

* For more compatible profiles, visit corelightingusa.com

RECESSED PROFILES

ALP-230RN

LENGTHS 49" | 98"
LENS Frosted
FINISH Silver

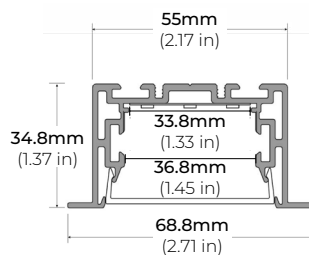

ALP-330RN

LENGTHS 49" | 98"
LENS Frosted
FINISH Silver

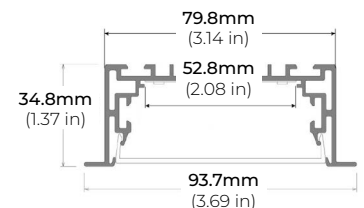

* For more compatible profiles, visit corelightingusa.com

LSPW-80 RGB+W

8.8W OUTDOOR COLOR CHANGING + WHITE LED STRIP

DMX CONTROLLERS

RGB CT600
MULTI-FUNCTION RGBW WALL CONTROLLER

INPUT VOLTAGE 5V DC, 1A
OUTPUT SIGNAL RF 2.4GHZ + DMX512
CONTROL 4 ZONES
COLOR OPTIONS Black/ White
WORKING TEMP -20°C ~ 40°C
DIMENSIONS LxWxH (5.19"x7.08"x1.38")

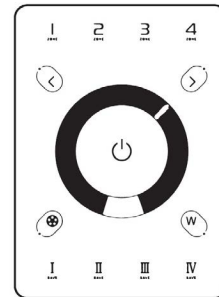

RGB-SCW4
WiFi DMX WALL CONTROLLER

INPUT VOLTAGE 5 - 10V DC, 06A
OUTPUT SIGNAL DMX512 (x2)
PROGRAMMABILITY PC/ MAC
COLOR OPTIONS Black/ White
CONNECTIONS USB/ 8dry contact ports/ Open drain output (for relay)
MEMORY Built-In Flash
WORKING TEMP -10°C ~ 45°C
DIMENSIONS LxWxH (5.75"x4.17"x0.43")

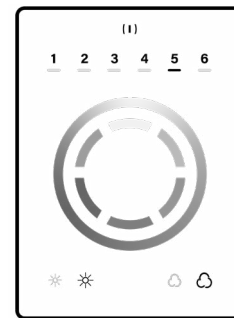

RGB-SDE3
WiFi DMX WALL CONTROLLER

INPUT VOLTAGE 6V DC, 0.6A
OUTPUT SIGNAL DMX512 (x2)
PROGRAMMABILITY PC/ MAC/ Tablet/ Smartphone
COLOR OPTIONS Black/ White
CONNECTION USB/ Ethernet/ RS232/ CLock/ 8dry contact ports/ 5V output relay
MEMORY MicroSD Card
WORKING TEMP -20°C ~ 40°C
DIMENSIONS LxWxH (5.75"x4.17"x0.43")

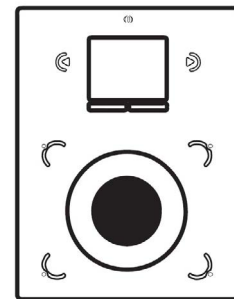

LSPW-80 RGB+W

8.8W OUTDOOR COLOR CHANGING + WHITE LED STRIP

DMX DECODERS

RGB-DMX-4C-RJ45 4-CHANNEL DMX DECODER

INPUT VOLTAGE 12V-24V DC
OUTPUT CURRENT 8A X 4CH
OUTPUT WATTAGE 4 x (96W ~ 288W)
OUTPUT CHANNELS 4
DIMENSIONS LxWxH (6.5"x2.38"x1.27")

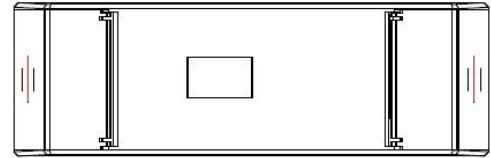

RGB-DMX-5C-XLR 5-CHANNEL DMX DECODER

INPUT VOLTAGE 12V-24V DC
OUTPUT CURRENT 8A X 5CH
OUTPUT WATTAGE 5 x (96W ~ 192W)
OUTPUT CHANNELS 5
DIMENSIONS LxWxH (6.45"x2.87"x1.5")

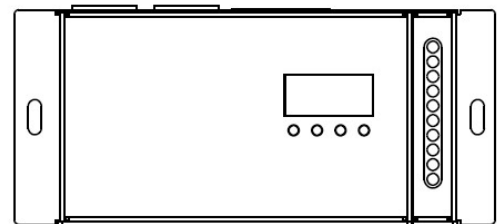

LSPW-80 RGB+W

8.8W OUTDOOR COLOR CHANGING + WHITE LED STRIP

NON-DMX CONTROLLERS

RGB-CT550

RGBW WIRELESS RECEIVER / CONTROLLER SYSTEM

REMOTE DISTANCE	100 Ft. (Line of Sight)
FREQUENCY	2.4 GHz
DIMENSIONS	LxWxH (6.38"x1.65"x0.59")
WEIGHT	0.44lbs.

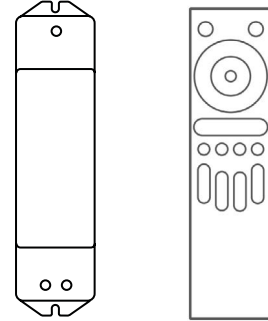

* RGB-CT500-RX
(Sold Separately)

RGB-CT550-RX

RGBW WIRELESS RECEIVER / CONTROLLER SYSTEM

INPUT VOLTAGE	DC5V ~ DC24V
POWER CAPACITY	100W (5V) 240W (12V) 480W (24V)
OUTPUT CURRENT	5A per Channel (20A Total)
WORKING TEMP	-30°C~55°C (-22°F~131°F)
DIMENSIONS	LxWxH (6.89"x1.73"x1.18")

* RGB-CT500-RX (Sold Separately)

RGB-CT700

MASTER RGBW WIFI CONTROLLER

INPUT VOLTAGE	12-24V DC
OUTPUT TYPE	Constant Voltage
POWER CAPACITY	288W (12V) 384W (24V)
OUTPUT CURRENT	5A per Channel (20A Total)
WORKING TEMP	-4°F (-20°C) ~ 122°F (50°C)
DIMENSIONS	LxWxH (7 x1.8 x 0.8")

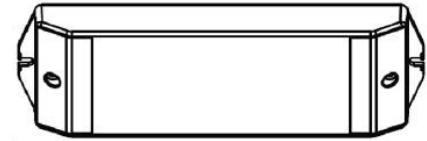

* Paired with RGB-CT705ZR (Sold Separately)

RGB-CT705ZR

SLAVE RGBW WIFI CONTROLLER

INPUT VOLTAGE	12-24V DC
OUTPUT TYPE	Constant Voltage
POWER CAPACITY	288W (12V) 384W (24V)
OUTPUT CURRENT	5A per Channel (20A Total)
WORKING TEMP	-4°F (-20°C) ~ 122°F (50°C)
DIMENSIONS	LxWxH (7 x0,63 x 0.71")

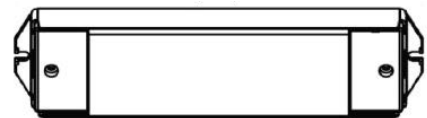

* Paired with RGB-CT700 (Sold Separately)

LSPW-80 RGB+W

8.8W OUTDOOR COLOR CHANGING + WHITE LED STRIP

NON-DMX CONTROLLERS (CONTINUED)

RGB-CT840 BLUETOOTH TOUCH PANEL WALL CONTROLLER

INPUT VOLTAGE	12-24V DC
ZONES	4
CONTROL MODE	RGB RGBW
WIRELESS PROTOCOL	Bluetooth 5.0 SIG Mesh
WORKING TEMP	-20°C ~ 55°C
DIMENSIONS	LxWxH (4.7"x3"x1.2")

** Paired with RGB-CT800-RC (Sold Separately)*



RGB-CT800-RC BLUETOOTH CONSTANT VOLTAGE LED RECEIVER

INPUT VOLTAGE	12V 24V
OUTPUT CURRENT	4Ax5CH / 5Ax4CH (20A Max)
POWER CAPACITY	240W (12V) 480W (24V)
PROGRAMMABILITY	iOS and Android
WORKING TEMP	-20°C ~ 55°C
DIMENSIONS	LxWxH (6.9 x1.7 x 1.2")

** Paired with RGB-CT840 (Sold Separately)*



NON-DIMMING DRIVERS (COMPATIBLE WITH ALL SYSTEMS)

PSHK SERIES NON-DIMMING CONSTANT VOLTAGE WITH JUNCTION BOX

PSHK-30W-24V	CLASS 2	6.5" X 3.6" X 1.02"
PSHK-60W-24V	CLASS 2	7.4" X 3.62" X 1.02"
PSHK-96W-24V	CLASS 2	8.66" X 3.66" X 1.61"
PSHK-150W-24V		10.24" X 4.06" X 1.81"
PSHK-200W-24V		10.24" X 4.06" X 1.81"
PSHK-288W-24V	CLASS 2	11.85" X 4.25" X 1.82"
PSHK-300W-24V		10.24" X 4.25" X 1.81"

