

LSP-80 RGB+W

8.8W INDOOR COLOR CHANGING + WHITE LED STRIP

Project _____

Location _____

Quote/ Ref # _____

LSP-80 RGBW is an indoor rated color-changing plus white LED strip that provides a full spectrum of color changing schemes. The warm or cool white LED's combined with the full color spectrum of the RGB light array produces more powerful color options that's sure to please even the most discerning lighting designer. Suitable for residential, commercial, hospitality and architectural lighting applications.

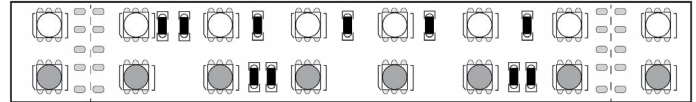

SPECIFICATIONS

INPUT VOLTAGE	24V DC
POWER CONSUMPTION	8.8W/Ft. <i>(4.4W/Ft. — RGB 4.4W/Ft. — White)</i>
LEDS/ FT.	36 LEDs per Ft.
LUMEN OUTPUT	475 Lm/ Ft. (RGB+3000K)
CRI	90+
COLOR TEMPERATURE	RGB+27K / RGB+30K / RGB+40K / RGB+50K
DIMMING	Through RGBW Controller
MAXIMUM RUN LENGTH	20 Ft.
CUTTABLE	Every 3.94 in. (100mm)
OPERATING TEMPERATURE	-40°F (-40°C) to 140°F (60°C)
BEAM ANGLE	120°
IP RATING	Indoor
CERTIFICATIONS	UL Listed
LUMEN MAINTENANCE	50,000 Hrs.

FEATURES

- 8.8W/Ft.
- 145 Lm. (RGB) | 330 Lm. (White)
- 90+ CRI (White)
- Two rows of high-output diodes
- Field Cuttable
- Ideal for color changing accent lighting
- UL Listed

LUMENS

CCT	RGB (LM/FT)	WHITE (LM/FT)	RGBW (LM/FT)
2700K	180	344	524
3000K	180	346	526
4000K	180	369	549
5000K	180	369	549



MODEL	COLOR TEMP	LENGTH	VOLTAGE	PROFILE
LSP-80	RGBW27K RGB + 2700K	16 16 Ft.	24 24V DC	See Pages 2-3 for compatible profiles.
	RGBW30K RGB + 3000K	100 100 Ft.		
	RGBW40K RGB + 4000K	PF Per Ft.		
	RGBW50K RGB + 5000K			

* Custom color finishes require powder coating. Allow 7 days leads time.

LSP-80 RGB+W

8.8W INDOOR COLOR CHANGING + WHITE LED STRIP

DIMENSIONS

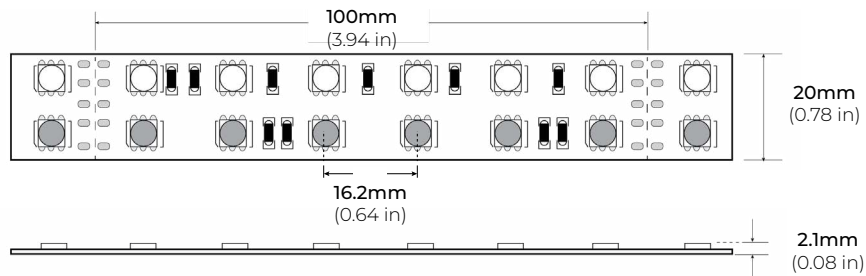

COMPATIBLE ALUMINUM PROFILES

SURFACE PROFILES

ALU-DS100

LENGTHS 39" | 78" | 84"
LENS Clear, Frosted
FINISH Silver

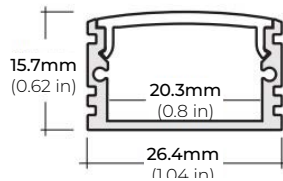

ALP-90

LENGTHS 48" | 96"
LENS Frosted
FINISH Black | Silver

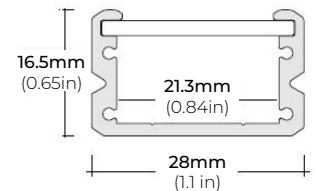

ALP-100C (CORNER)

LENGTHS 48" | 98"
LENS Frosted
FINISH Silver

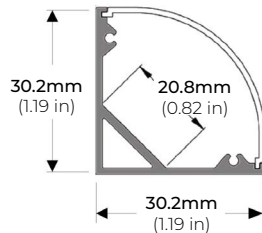

ALP-102

LENGTHS 49" | 98"
LENS Frosted, Black, Asymmetric, Double Asymmetric
FINISH Black | Silver | White

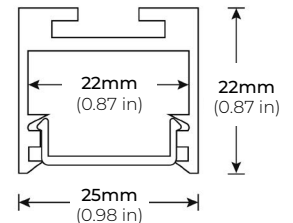

ALP-130

LENGTHS 49" | 84" | 98"
LENS Frosted
FINISH Silver | Black

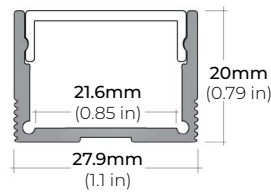

ALP-140

LENGTHS 48" | 98"
LENS Frosted
FINISH Silver

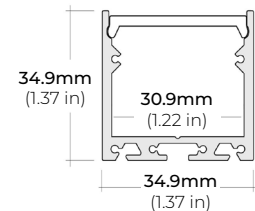

ALP-150LX

LENGTHS 49" | 98"
LENS Frosted
FINISH White | Black

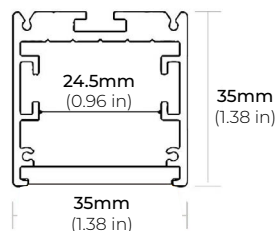

ALP-160

LENGTHS 49" | 98"
LENS Frosted
FINISH Silver

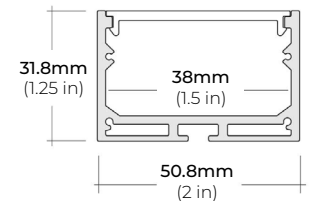

ALP-190

LENGTHS 48" | 98"
LENS Frosted
FINISH Silver

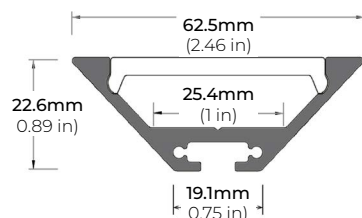

ALP-230N

LENGTHS 49" | 98"
LENS Frosted
FINISH Silver

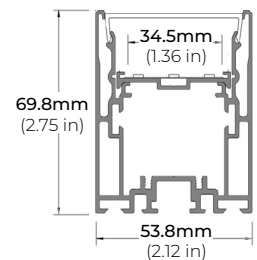

* For more compatible profiles, visit corelightingusa.com

LSP-80 RGB+W

8.8W INDOOR COLOR CHANGING + WHITE LED STRIP

COMPATIBLE ALUMINUM PROFILES

RECESSED PROFILES

ALP-210RN

LENGTHS 49" | 98"
LENS Frosted
FINISH Silver

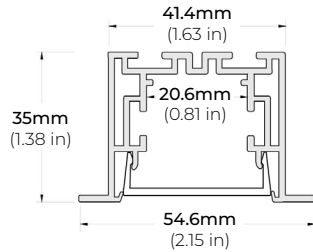

ALP-230RN

LENGTHS 49" | 98"
LENS Frosted
FINISH Silver

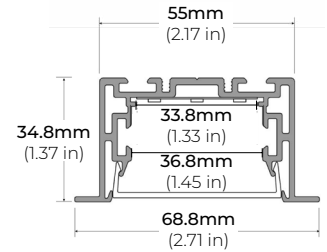

* For more compatible profiles, visit corelightingusa.com

TRIMLESS PROFILES

ALP-350TL

LENGTHS 48" | 96"
LENS Frosted
FINISH Anodized Silver

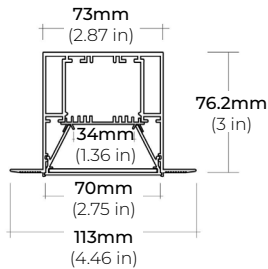

ALP-2300TL

LENGTHS 48" | 96"
LENS Frosted
FINISH White

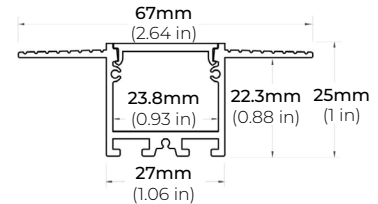

ALP-2400TL

LENGTHS 48" | 96"
LENS Clear, Frosted
FINISH White

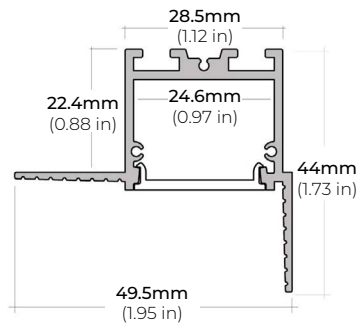

ALP-2700TL

LENGTHS 48" | 96"
LENS Frosted
FINISH White

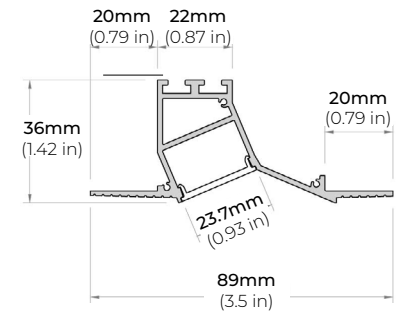

ALP-2800TL

LENGTHS 49" | 98"
LENS Frosted
FINISH Matte White

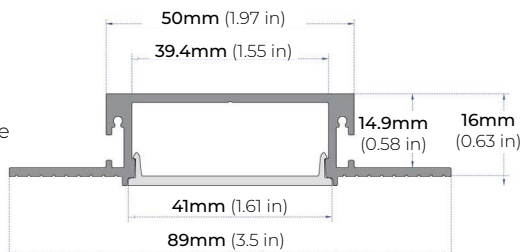

ALP-3100TLX

LENGTHS 49" | 98"
LENS Frosted
FINISH Matte White

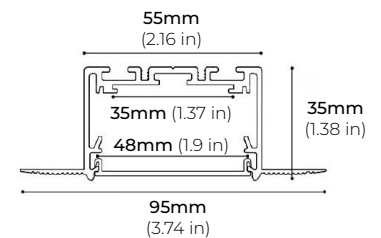

* For more compatible profiles, visit corelightingusa.com

LSP-80 RGB+W

8.8W INDOOR COLOR CHANGING + WHITE LED STRIP

DMX CONTROLLERS

RGB CT600 MULTI-FUNCTION RGBW WALL CONTROLLER

INPUT VOLTAGE	5V DC, 1A
OUTPUT SIGNAL	RF 2.4GHZ + DMX512
CONTROL	4 ZONES
COLOR OPTIONS	Black/ White
WORKING TEMP	-20°C ~ 40°C
DIMENSIONS	LxWxH (5.19"x7.08"x1.38")

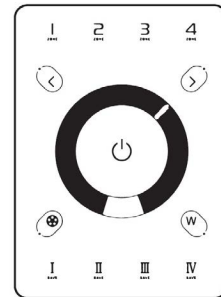

RGB-SCW4 WiFi DMX WALL CONTROLLER

INPUT VOLTAGE	5 - 10V DC, 06A
OUTPUT SIGNAL	DMX512 (x2)
PROGRAMMABILITY	PC/ MAC
COLOR OPTIONS	Black/ White
CONNECTIONS	USB/ 8dry contact ports/ Open drain output (for relay)
MEMORY	Built-In Flash
WORKING TEMP	-10°C ~ 45°C
DIMENSIONS	LxWxH (5.75"x4.17"x0.43")

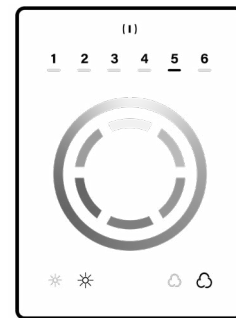

RGB-SDE3 WiFi DMX WALL CONTROLLER

INPUT VOLTAGE	6V DC, 0.6A
OUTPUT SIGNAL	DMX512 (x2)
PROGRAMMABILITY	PC/ MAC/ Tablet/ Smartphone
COLOR OPTIONS	Black/ White
CONNECTION	USB/ Ethernet/ RS232/ CLock/ 8dry contact ports/ 5V output relay
MEMORY	MicroSD Card
WORKING TEMP	-20°C ~ 40°C
DIMENSIONS	LxWxH (5.75"x4.17"x0.43")

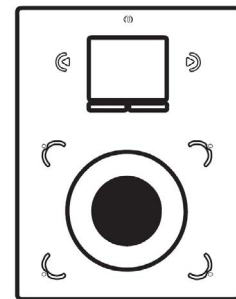

LSP-80 RGB+W

8.8W INDOOR COLOR CHANGING + WHITE LED STRIP

DMX DECODERS

RGB-DMX-4C-RJ45 4-CHANNEL DMX DECODER

INPUT VOLTAGE 12V-24V DC
OUTPUT CURRENT 8A X 4CH
OUTPUT WATTAGE 4 x (96W ~ 288W)
OUTPUT CHANNELS 4
DIMENSIONS LxWxH (6.5"x2.38"x1.27")

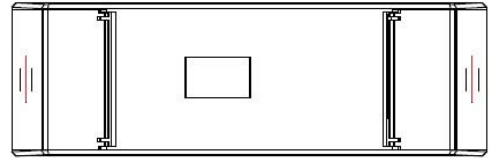

RGB-DMX-5C-XLR 5-CHANNEL DMX DECODER

INPUT VOLTAGE 12V-24V DC
OUTPUT CURRENT 8A X 5CH
OUTPUT WATTAGE 5 x (96W ~ 192W)
OUTPUT CHANNELS 5
DIMENSIONS LxWxH (6.45"x2.87"x1.5")

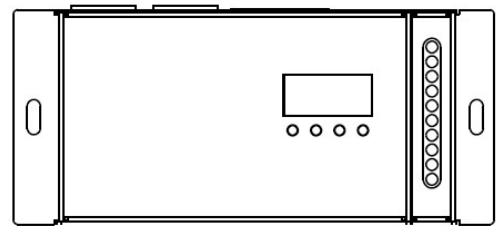

LSP-80 RGB+W

8.8W INDOOR COLOR CHANGING + WHITE LED STRIP

NON-DMX CONTROLLERS

RGB-CT550

RGBW WIRELESS RECEIVER / CONTROLLER SYSTEM

REMOTE DISTANCE	100 Ft. (Line of Sight)
FREQUENCY	2.4 GHz
DIMENSIONS	LxWxH (6.38"x1.65"x0.59")
WEIGHT	0.44lbs.

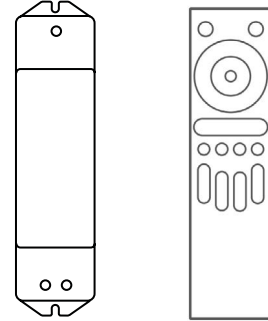

* RGB-CT500-RX
(Sold Separately)

RGB-CT550-RX

RGBW WIRELESS RECEIVER / CONTROLLER SYSTEM

INPUT VOLTAGE	DC5V ~ DC24V
POWER CAPACITY	100W (5V) 240W (12V) 480W (24V)
OUTPUT CURRENT	5A per Channel (20A Total)
WORKING TEMP	-30°C~55°C (-22°F~131°F)
DIMENSIONS	LxWxH (6.89"x1.73"x1.18")

* RGB-CT500-RX (Sold Separately)

RGB-CT700

MASTER RGBW WIFI CONTROLLER

INPUT VOLTAGE	12-24V DC
OUTPUT TYPE	Constant Voltage
POWER CAPACITY	288W (12V) 384W (24V)
OUTPUT CURRENT	5A per Channel (20A Total)
WORKING TEMP	-4°F (-20°C) ~ 122°F (50°C)
DIMENSIONS	LxWxH (7 x1.8 x 0.8")

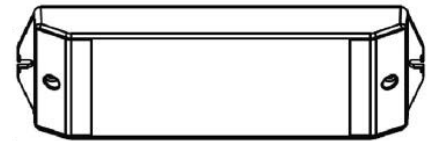

* Paired with RGB-CT705ZR (Sold Separately)

RGB-CT705ZR

SLAVE RGBW WIFI CONTROLLER

INPUT VOLTAGE	12-24V DC
OUTPUT TYPE	Constant Voltage
POWER CAPACITY	288W (12V) 384W (24V)
OUTPUT CURRENT	5A per Channel (20A Total)
WORKING TEMP	-4°F (-20°C) ~ 122°F (50°C)
DIMENSIONS	LxWxH (7 x0,63 x 0.71")

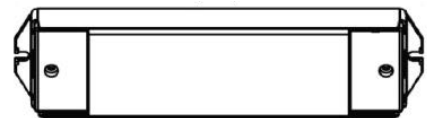

* Paired with RGB-CT700 (Sold Separately)

LSP-80 RGB+W

8.8W INDOOR COLOR CHANGING + WHITE LED STRIP

NON-DMX CONTROLLERS (CONTINUED)

RGB-CT840

BLUETOOTH TOUCH PANEL WALL CONTROLLER

INPUT VOLTAGE	12-24V DC
ZONES	4
CONTROL MODE	RGB RGBW
WIRELESS PROTOCOL	Bluetooth 5.0 SIG Mesh
WORKING TEMP	-20°C ~ 55°C
DIMENSIONS	LxWxH (4.7"x3"x1.2")

** Paired with RGB-CT800-RC (Sold Separately)*



RGB-CT800-RC

BLUETOOTH CONSTANT VOLTAGE LED RECEIVER

INPUT VOLTAGE	12V 24V
OUTPUT CURRENT	4Ax5CH / 5Ax4CH (20A Max)
POWER CAPACITY	240W (12V) 480W (24V)
PROGRAMMABILITY	iOS and Android
WORKING TEMP	-20°C ~ 55°C
DIMENSIONS	LxWxH (6.9 x1.7 x 1.2")

** Paired with RGB-CT840 (Sold Separately)*



NON-DIMMING DRIVERS (COMPATIBLE WITH ALL SYSTEMS)

PSHK SERIES

NON-DIMMING CONSTANT VOLTAGE WITH JUNCTION BOX

PSHK-30W-24V	CLASS 2	6.5" X 3.6" X 1.02"
PSHK-60W-24V	CLASS 2	7.4" X 3.62" X 1.02"
PSHK-96W-24V	CLASS 2	8.66" X 3.66" X 1.61"
PSHK-150W-24V		10.24" X 4.06" X 1.81"
PSHK-200W-24V		10.24" X 4.06" X 1.81"
PSHK-288W-24V	CLASS 2	11.85" X 4.25" X 1.82"
PSHK-300W-24V		10.24" X 4.25" X 1.81"

