

# LSP-50

## 4.4W INDOOR FLEXIBLE LED STRIP

Project \_\_\_\_\_

Location \_\_\_\_\_

Quote/ Ref # \_\_\_\_\_

**LSP-50** is a dimmable flexible LED strip capable of delivering 380 Lumens of light output per Ft. This LED strip is rated to last 50,000 hours making it an excellent replacement for halogen lighting. Its innovative low profile design makes it suitable for use in cove lighting, under cabinets architectural and aesthetic enhancements.



### SPECIFICATIONS

INPUT VOLTAGE	12V   24V DC
POWER CONSUMPTION	4.4W/Ft.
NO. OF LEDS	18 LEDs per Ft.
LUMEN OUTPUT	380 Lm/Ft.
CRI	95+
COLOR TEMPERATURE	25K / 27K / 30K / 35K / 40K / 50K / 60K
DIMMING	MLV, ELV, 0-10 and TRIAC
MAXIMUM RUN LENGTH	16 Ft. (12V)   24 Ft. (24V)
CUTTABLE	Every 1.97 in (50mm) (12V) Every 3.93 in (99.75mm) (24V)
BINNING	1.5 Step Macadam Elipse
OPERATING TEMPERATURE	-40°F (-40°C) ~ +140°F (+60°C)
BEAM ANGLE	120°
IP RATING	IP45 dry location (Indoor)
CERTIFICATIONS	UL Listed, TITLE 24 JA8
LUMEN MAINTENANCE	50,000 Hrs.

\*Approved for closet / storage space installation per NEC 410.16(A)(3) and 410.16(C)(5)



MODEL	COLOR TEMP	LENGTH	VOLTAGE	PROFILE
<b>LSP50</b>	<b>25K</b> 2500K	<b>16</b> 16 Ft.	<b>12</b> 12V	<i>See Page 3 for compatible profiles.</i>
	<b>27K</b> 2700K	<b>100</b> 100 Ft.	<b>24</b> 24V DC	
	<b>30K</b> 3000K	<b>1XX</b> per Ft.		
	<b>35K</b> 3500K			
	<b>40K</b> 4000K			
	<b>50K</b> 5000K			
	<b>60K</b> 6000K			
		*1 = Custom length per FT. (12V Strip cuttable every 1.97") (24V Strip cuttable every 3.93")		* Custom color finishes require powder coating. Allow 7 days leads time.

# LSP-50

## 4.4W INDOOR FLEXIBLE LED STRIP

### DIMENSIONS

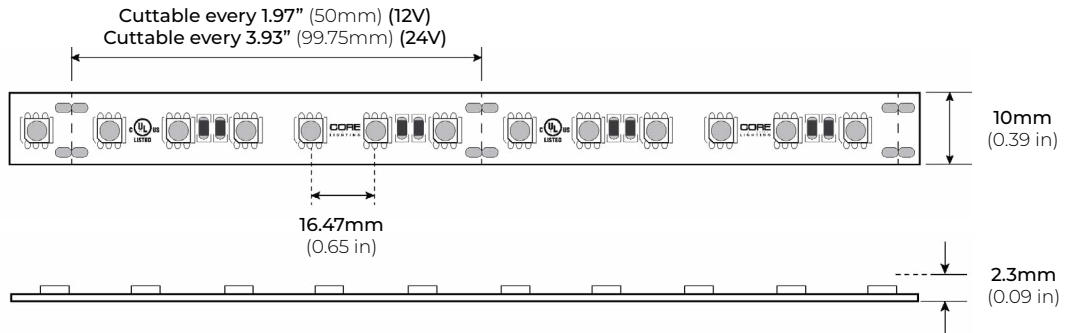

### COMPATIBLE CONNECTORS

#### HP PRO CONNECTORS

QUICK CONNECT SNAP-ON

- LSA-HW8-HP 8" HARDWIRE CONNECTOR
- LSA-HW24-HP 24" HARDWIRE CONNECTOR
- LSA-HW60-HP 60" HARDWIRE CONNECTOR
- LSA-HW120-HP 120" HARDWIRE CONNECTOR

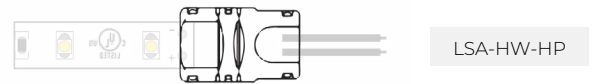

- LSA-EX3-HP 3" LINK
- LSA-EX8-HP 8" LINK
- LSA-EX24-HP 24" LINK

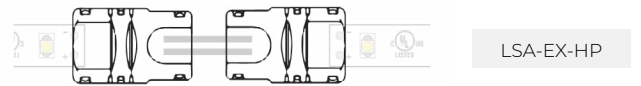

- LSA-MC-HP MINI COUPLING



- LSA-DC24-HP 24" DC CONNECTOR

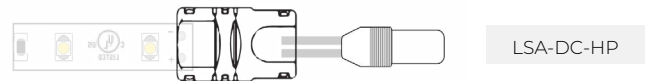

#### LSA-TB

SOLDERLESS LED STRIP/ WIRE BLOCK CONNECTOR

- LSA-TB-HWC-2A 2 AMP MAX HARDWIRE CONNECTOR  
(0.53" X 0.45" X 0.26")  
48W MAX (24V)



- LSA-TB-HWC-4A 4 AMP MAX HARDWIRE CONNECTOR  
(0.45" X 0.48" X 0.31")  
96W MAX (24V)



- LSA-TB-MC-4A 4 AMP MAX STRIP TO STRIP CONNECTOR  
(0.45" X 0.48" X 0.31")  
96W MAX (24V)



# LSP-50

## 4.4W INDOOR FLEXIBLE LED STRIP

### COMPATIBLE ALUMINUM PROFILES

#### SURFACE PROFILES

##### ALU-SF

LENGTHS 39" | 78" | 84" | 98"  
LENS Clear, Frosted  
FINISH Black | Silver

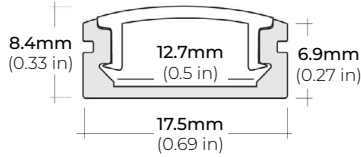

##### ALU-CN (CORNER)

LENGTHS 39" | 78" | 84" | 96"  
LENS Clear, Frosted  
FINISH Black | Silver

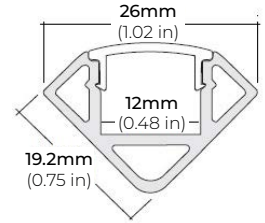

##### ALU-DS100

LENGTHS 39" | 78" | 84"  
LENS Clear, Frosted  
FINISH Silver

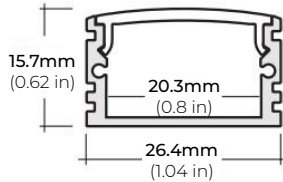

##### ALP-20

LENGTHS 49" | 84" | 98"  
LENS Frosted  
FINISH White | Black | Silver

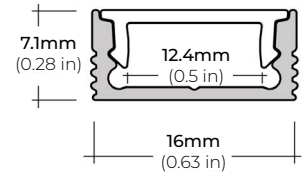

##### ALP-35

LENGTHS 49" | 98"  
LENS Frosted  
FINISH White | Black | Silver

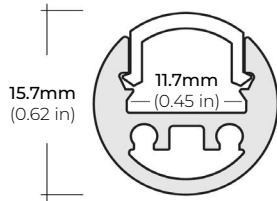

##### ALP-50C-V2 (CORNER)

LENGTHS 48" | 84" | 98"  
LENS Frosted  
FINISH White | Black | Silver

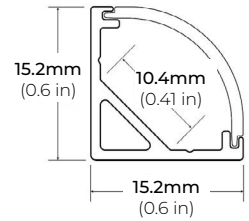

##### ALP-60

LENGTHS 49" | 84" | 98"  
LENS Frosted  
FINISH White | Black | Silver

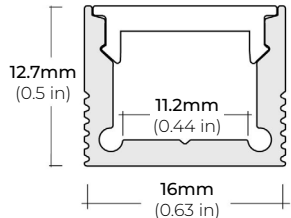

##### ALP-65

LENGTHS 48" | 96"  
LENS Clear  
FINISH Silver

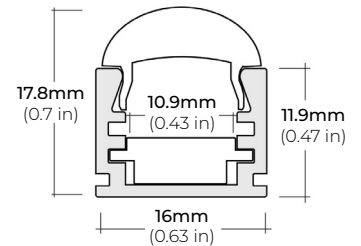

##### ALP-70

LENGTHS 49" | 84" | 98"  
LENS Frosted  
FINISH White | Black | Silver

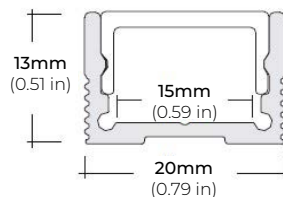

##### ALP-80

LENGTHS 49" | 98"  
LENS Frosted  
FINISH Silver

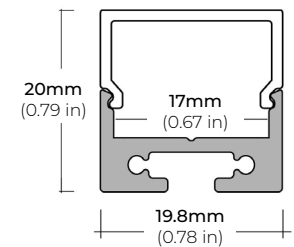

\* For more compatible profiles, visit [corelightingusa.com](http://corelightingusa.com)

#### RECESSED PROFILES

##### ALP-20R

LENGTHS 49" | 98"  
LENS Frosted  
FINISH White | Black | Silver

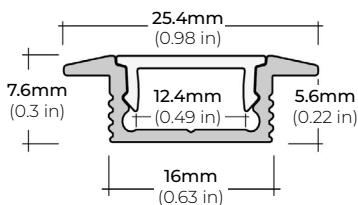

##### ALP-60R

LENGTHS 49" | 84" | 98"  
LENS Frosted  
FINISH White | Black | Silver

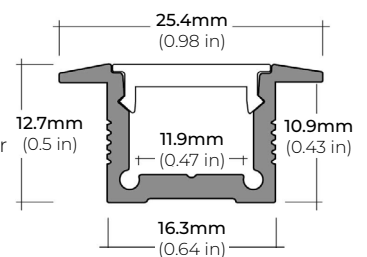

\* For more compatible profiles, visit [corelightingusa.com](http://corelightingusa.com)

# LSP-50

## 4.4W INDOOR FLEXIBLE LED STRIP

### COMPATIBLE TRANSFORMERS

#### PSDL SERIES TRIAC DIMMABLE

PSDL-30W-12V	CLASS 2	6.5" X 3.63" X 1.58"
PSDL-60W-12V	CLASS 2	7.4" X 3.63" X 1.58"
PSDL-100W-12V	CLASS 2	8.67" X 3.67 X 1.62"
PSDL-150W-12V		10.25" X 4.06" X 1.82"
PSDL-200W-12V		10.25" X 4.06" X 1.82"
PSDL-300W-12V		10.25" X 4.06" X 1.82"

PSDL-30W-24V	CLASS 2	6.5" X 3.63" X 1.58"
PSDL-60W-24V	CLASS 2	7.4" X 3.63" X 1.58"
PSDL-96W-24V	CLASS 2	8.67" X 3.67 X 1.62"
PSDL-150W-24V		10.25" X 4.06" X 1.82"
PSDL-192W-24V	CLASS 2	11" X 4" X 1.82"
PSDL-200W-24V		10.25" X 4.06" X 1.82"
PSDL-288W-24V	CLASS 2	11.85" X 4.25" X 1.82"
PSDL-300W-24V		10.25" X 4.06" X 1.82"

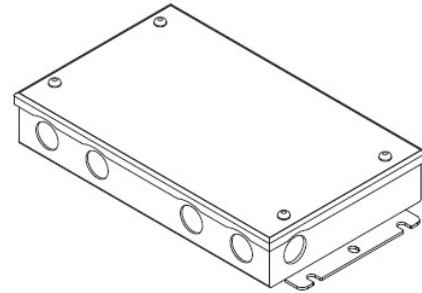

#### PSDH SERIES HIGH PERFORMANCE MAGNETIC LOW VOLTAGE (MLV)

PSDH-48W-24V	CLASS 2	11.25" X 3.37" X 3.25"
PSDH-96W-24V	CLASS 2	11.25" X 3.37" X 3.25"
PSDH-288W-24V	CLASS 2	14.25" X 8.43" X 4.43"

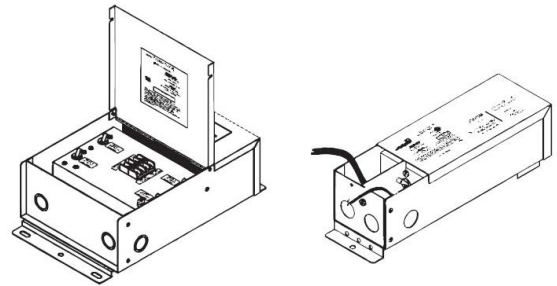

#### PSRX SERIES 4-IN-1 DIMMING DRIVER W/ JUNCTION BOX

PSRX-30W-12V-UNV	CLASS 2	6.5" X 3.72" X 1.57"
PSRX-60W-12V-UNV	CLASS 2	7.4" X 3.72" X 1.57"
PSRX-150W-12V-UNV		10.24" X 4.13" X 1.77"
PSRX-30W-24V-UNV	CLASS 2	6.5" X 3.7" X 1.57"
PSRX-60W-24V-UNV	CLASS 2	7.4" X 3.72" X 1.57"
PSRX-96W-24V-UNV	CLASS 2	8.66" X 3.72" X 1.57"
PSRX-150W-24V-UNV		10.24" X 4.13" X 1.77"
PSRX-200W-24V-UNV		10.24" X 4.13" X 1.77"
PSRX-300W-24V-UNV		10.94" X 4.33" X 1.77"

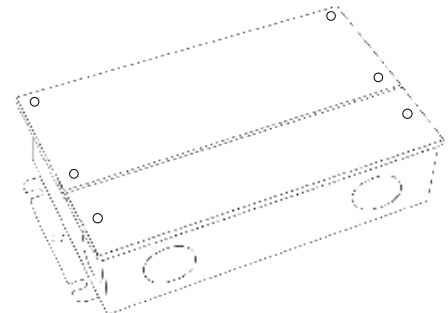

# LSP-50

## 4.4W INDOOR FLEXIBLE LED STRIP

### COMPATIBLE TRANSFORMERS

#### PSVT SERIES 0-10V DIMMING DRIVER

PSVT-60W-24V	CLASS 2	7.4" X 3.72" X 1.57"
PSVT-96W-24V	CLASS 2	8.66" X 3.72" X 1.57"
PSVT-200W-24V		10.24" X 4.13" X 1.77"
PSVT-288W-24V	CLASS 2	11.85" X 4.25" X 1.81"
PSVT-300W-24V		10.94" X 4.33" X 1.77"

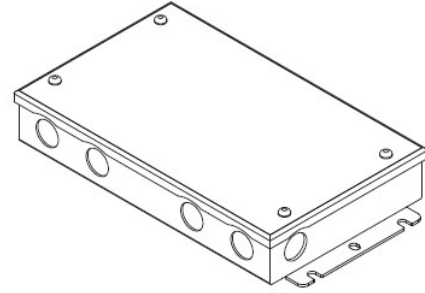

#### PSDE SERIES 0-10V DIMMING W/ JUNCTION BOX

PSDE-60W-24V-010-JB	CLASS 2	12.1" X 2.36" X 1.4"
PSDE-96W-24V-010-JB	CLASS 2	12.1" X 2.36" X 1.4"

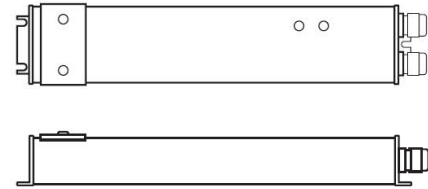

#### LUTRON 1% 3-WIRE DIMMING

L3DA4U1UKL-CV240	CLASS 2	4.0" X 1.5" X 4.0"
------------------	---------	--------------------

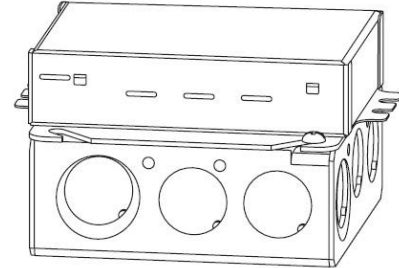

#### LUTRON 1% 3-WIRE DIMMING

PSDE-96W-24V-ECO	CLASS 2	10.5" X 3.0" X 2.0"
------------------	---------	---------------------

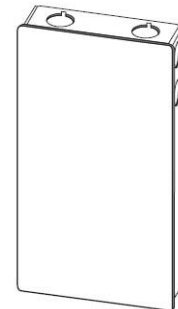

# LSP-50

## 4.4W INDOOR FLEXIBLE LED STRIP

### COMPATIBLE NON-DIMMING DRIVERS

#### PSHK SERIES

NON-DIMMING CONSTANT VOLTAGE WITH JUNCTION BOX

PSHK-30W-24V	CLASS 2	6.5" X 3.6" X 1.02"
PSHK-60W-24V	CLASS 2	7.4" X 3.62" X 1.02"
PSHK-96W-24V	CLASS 2	8.66" X 3.66" X 1.61"
PSHK-150W-24V		10.24" X 4.06" X 1.81"
PSHK-200W-24V		10.24" X 4.06" X 1.81"
PSHK-288W-24V	CLASS 2	11.85" X 4.25" X 1.82"
PSHK-300W-24V		10.24" X 4.25" X 1.81"

