

LSM-46CB

4.6W INDOOR COB LINEAR LED STRIP

Project _____
Location _____
Quote/ Ref # _____

Cuttable to any length and able to deliver a solid stream of linear light, the **LSM- 46CB** features the latest in COB technology (Chip On-Board) for total linear diffusion in a low profile package.



SPECIFICATIONS

INPUT VOLTAGE	24V DC
POWER CONSUMPTION	4.6W/Ft.
LUMEN OUTPUT	521 Lm/Ft. (30K)
NO. OF LEDs	98 LEDs/ Ft.
CRI	90+
DIMMING	MLV, ELV, 0-10 and TRIAC
MAXIMUM RUN LENGTH	16.4 Ft.
CUTTABLE	Free-cutting Length, 1 LED
OPERATING TEMPERATURE	-4°F (-20°C) ~ 113°F (45°C)
BEAM ANGLE	120°
IP RATING	Dry location (Indoor)
CERTIFICATIONS	UL Listed, TITLE 24 JAB
LUMEN MAINTENANCE	50,000 Hrs.

LUMENS

CCT	LM/ FT
2700K	494
3000K	521
4000K	549
5000K	549
6500K	549

*Approved for closet / storage space installation per NEC 410.16(A)(3) and 410.16(C)(5)



MODEL	COLOR TEMP	LENGTH	VOLTAGE	PROFILE
LSM46CB	27K 2700K	16 16 Ft.	24V 24V DC	See Page 3 for compatible profiles.
	30K 3000K	100 100 Ft.		
	40K 4000K	1XX per Ft.		
	50K 5000K			
	65K 6500K			
		*1 = Custom length per FT.		* Custom color finishes require powder coating. Allow 7 days leads time.

LSM-46CB

4.6W INDOOR COB LINEAR LED STRIP

DIMENSIONS



COMPATIBLE ALUMINUM PROFILES

SURFACE PROFILES

ALU-SF

LENGTHS 39" | 78" | 84" | 98"
LENS Clear, Frosted
FINISH Black | Silver

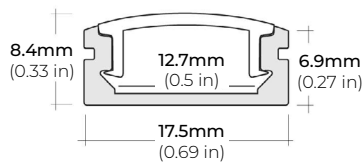

ALU-CN (CORNER)

LENGTHS 39" | 78" | 84" | 96"
LENS Clear, Frosted
FINISH Black | Silver

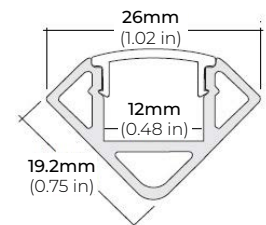

ALU-DS100

LENGTHS 39" | 78" | 84"
LENS Clear, Frosted
FINISH Silver

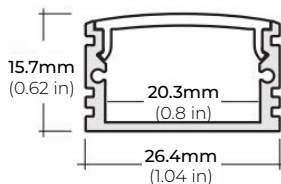

ALP-20

LENGTHS 49" | 84" | 98"
LENS Frosted
FINISH White | Black | Silver

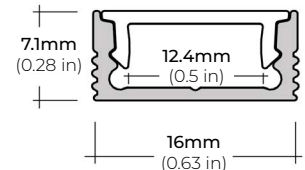

ALP-35

LENGTHS 49" | 98"
LENS Frosted
FINISH White | Black | Silver

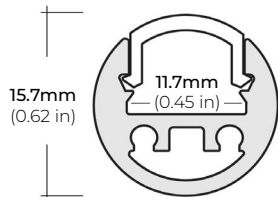

ALP-50C-V2 (CORNER)

LENGTHS 48" | 84" | 98"
LENS Frosted
FINISH White | Black | Silver

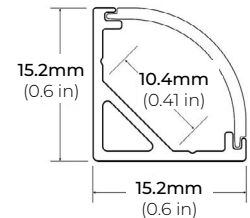

ALP-60

LENGTHS 49" | 84" | 98"
LENS Frosted
FINISH White | Black | Silver

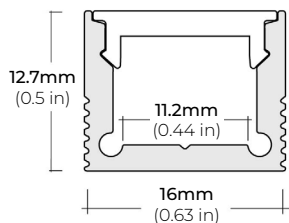

ALP-65

LENGTHS 48" | 96"
LENS Clear
FINISH Silver

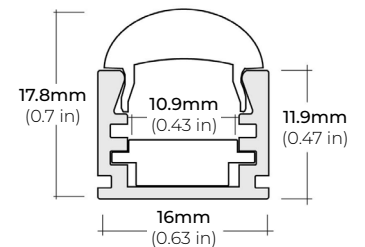

* For more compatible profiles, visit corelightingusa.com

RECESSED PROFILES

ALP-20R

LENGTHS 49" | 98"
LENS Frosted
FINISH White | Black | Silver

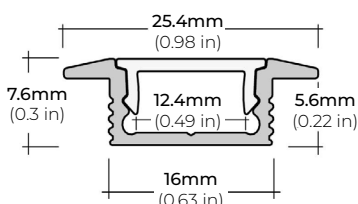

ALP-60R

LENGTHS 49" | 84" | 98"
LENS Frosted
FINISH White | Black | Silver

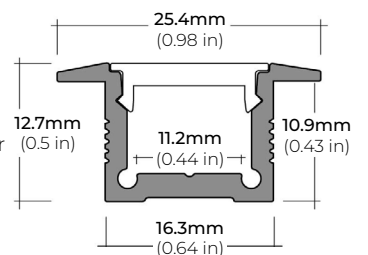

* For more compatible profiles, visit corelightingusa.com

LSM-46CB

4.6W INDOOR COB LINEAR LED STRIP

COMPATIBLE TRANSFORMERS

PSDL SERIES TRIAC DIMMABLE

PSDL-30W-24V	CLASS 2	6.5" X 3.63" X 1.03"
PSDL-60W-24V	CLASS 2	7.4" X 3.63" X 1.03"
PSDL-96W-24V	CLASS 2	8.67" X 3.67 X 1.62"
PSDL-150W-24V		8.67" X 3.67" X 1.62"
PSDL-192W-24V	CLASS 2	10.25" X 4.06" X 1.82"
PSDL-200W-24V		10.25" X 4.06" X 1.82"
PSDL-288W-24V	CLASS 2	10.25" X 4.06" X 1.82"
PSDL-300W-24V		10.25" X 4.06" X 1.82"

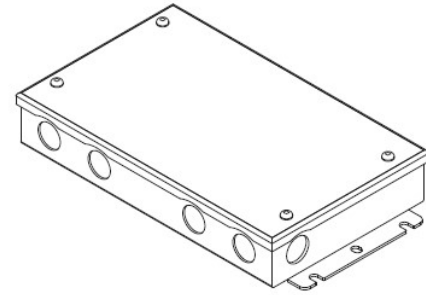

PSDH SERIES HIGH PERFORMANCE MAGNETIC LOW VOLTAGE (MLV)

PSDH-48W-24V	CLASS 2	11.25" X 3.37" X 3.25"
PSDH-96W-24V	CLASS 2	11.25" X 3.37" X 3.25"
PSDH-288W-24V	CLASS 2	14.25" X 8.43" X 4.43"

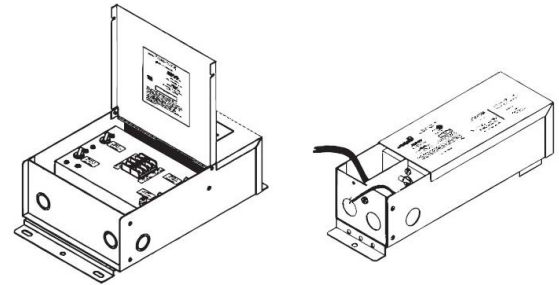

PSRX SERIES 4-IN-1 DIMMING DRIVER

PSRX-30W-24V	CLASS 2	6.5" X 3.72" X 1.57"
PSRX-60W-24V	CLASS 2	7.4" X 3.72" X 1.57"
PSRX-96W-24V	CLASS 2	8.66" X 3.72" X 1.57"
PSRX-150W-24V		10.24" X 4.13" X 1.77"
PSRX-192W-24V		11" X 4" X 1.82"
PSRX-200W-24V		10.24" X 4.13" X 1.77"
PSRX-288W-24V	CLASS 2	11.85" X 4.25" X 1.82"
PSRX-300W-24V		10.94" X 4.33" X 1.77"

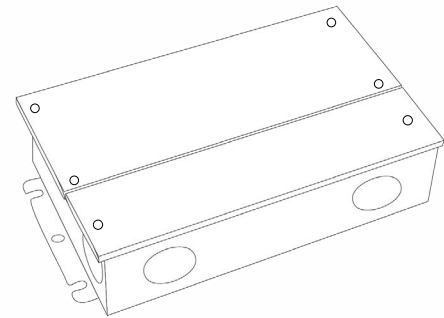

PSVT SERIES 0-10V DIMMING DRIVER

PSVT-60W-24V	CLASS 2	7.4" X 3.72" X 1.57"
PSVT-96W-24V	CLASS 2	8.66" X 3.72" X 1.57"
PSVT-200W-24V		10.24" X 4.13" X 1.77"
PSVT-288W-24V	CLASS 2	11.85" X 4.25" X 1.81"
PSVT-300W-24V		10.94" X 4.33" X 1.77"

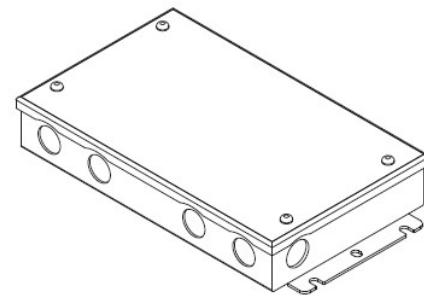

LSM-46CB

4.6W INDOOR COB LINEAR LED STRIP

COMPATIBLE TRANSFORMERS

PSDE SERIES
0-10V DIMMING W/ JUNCTION BOX

PSDE-60W-24V-010-JB	CLASS 2	12.1" X 2.36" X 1.4"
PSDE-96W-24V-010-JB	CLASS 2	12.1" X 2.36" X 1.4"

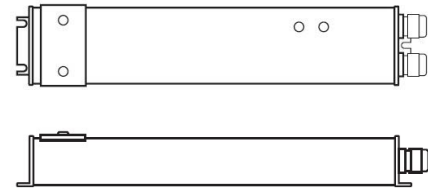

LUTRON 1%
3-WIRE DIMMING

L3DA4U1UKL-CV240	CLASS 2	4.0" X 1.5" X 4.0"
------------------	---------	--------------------

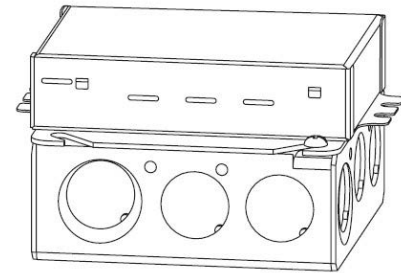

LUTRON 1%
3-WIRE DIMMING

PSDE-96W-24V-ECO	CLASS 2	10.5" X 3.0" X 2.0"
------------------	---------	---------------------

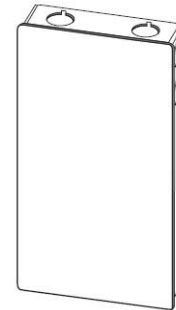

COMPATIBLE NON-DIMMING DRIVERS

PSHK SERIES
NON-DIMMING CONSTANT VOLTAGE WITH JUNCTION BOX

PSHK-30W-24V	CLASS 2	6.5" X 3.6" X 1.02"
PSHK-60W-24V	CLASS 2	7.4" X 3.62" X 1.02"
PSHK-96W-24V	CLASS 2	8.66" X 3.66" X 1.61"
PSHK-150W-24V		10.24" X 4.06" X 1.81"
PSHK-200W-24V		10.24" X 4.06" X 1.81"
PSHK-288W-24V	CLASS 2	11.85" X 4.25" X 1.82"
PSHK-300W-24V		10.24" X 4.25" X 1.81"

