

LSM-30

3W INDOOR FLEXIBLE LED STRIP

Project _____

Location _____

Quote/ Ref # _____

LSM-30 is a dimmable flexible LED strip capable of delivering 223 lumens of light output per ft. Suitable for use in cove lighting, under cabinets, architectural and aesthetic enhancements. It features superior CRI and different color temperature options.

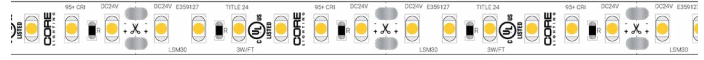

SPECIFICATIONS

INPUT VOLTAGE	12V 24V DC
POWER CONSUMPTION	3W per Ft.
NO. OF LEDs	36 LEDs per Ft.
LUMEN OUTPUT	223 Lm/Ft. (3000K)
CRI	95+
COLOR TEMPERATURE	22K / 24K / 27K / 30K / 35K / 40K / 50K 60K / RD / BL / GR / PK / PR / AM / OR
DIMMING	MLV, ELV, 0-10 AND TRIAC
MAXIMUM RUN LENGTH	16.4 Ft. (12V) 24 FT. (24V)
CUTTABLE	Every 1 in (25.4mm) (12V) Every 1.96 in (49.9mm) (24V)
BINNING	1.5 Step Macadam Elipse
OPERATING TEMPERATURE	-40°F (-40°C) ~ +140°F (+60°C)
BEAM ANGLE	120°
IP RATING	Dry location (Indoor)
CERTIFICATIONS	UL Listed, TITLE 24 JA8
LUMEN MAINTENANCE	50,000 Hrs.

LUMENS

CCT	LM/ FT	CRI	R9	R13
2200K	217	87	46	91
2400K	227	94	78	97
2700K	234	96	86	98
3000K	223	95	87	98
3500K	233	93	83	96
4000K	241	95	99	99
5000K	252	94	95	98
6000K	265	87	68	92
RED	98	-	-	-
GREEN	300	-	-	-
BLUE	71	-	-	-

*Approved for closet / storage space installation per NEC 410.16(A)(3) and 410.16(C)(5)



MODEL	COLOR TEMP		LENGTH	VOLTAGE	PROFILE
LSM30	22K 2200K	RD Red	16 16 Ft.	12V 12V	<i>See Page 3 for compatible profiles.</i>
	24K 2400K	BL Blue	100 100 Ft.	24V 24V DC	
	27K 2700K	GR Green	1XX per Ft.		
	30K 3000K	PK Pink			
	35K 3500K	PR Purple			
	40K 4000K	AM Amber			
	50K 5000K	OR Orange			
	60K 6000K				
		*1 = Custom length per FT. (12V Strip cuttable every 1") (24V Strip cuttable every 1.96")			* Custom color finishes require powder coating. Allow 7 days leads time.

LSM-30

3W INDOOR FLEXIBLE LED STRIP

DIMENSIONS

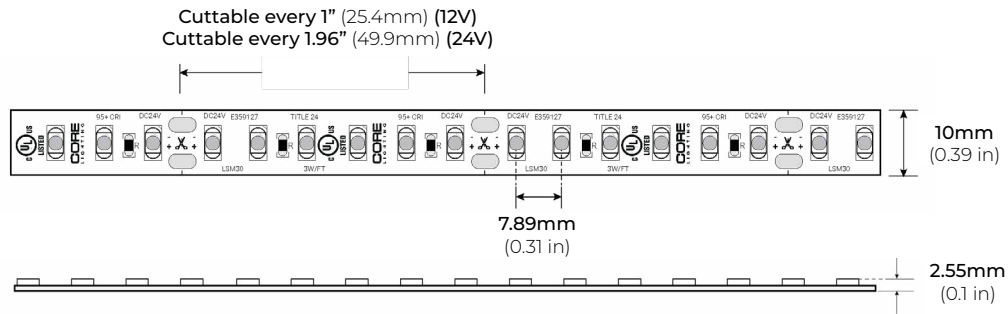

COMPATIBLE CONNECTORS

HP PRO CONNECTORS

QUICK CONNECT SNAP-ON

- LSA-HW8-HP 8" HARDWIRE CONNECTOR
- LSA-HW24-HP 24" HARDWIRE CONNECTOR
- LSA-HW60-HP 60" HARDWIRE CONNECTOR
- LSA-HW120-HP 120" HARDWIRE CONNECTOR

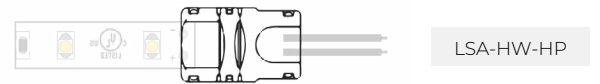

- LSA-EX3-HP 3" LINK
- LSA-EX8-HP 8" LINK
- LSA-EX24-HP 24" LINK

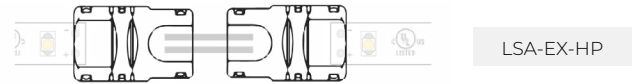

- LSA-MC-HP MINI COUPLING



- LSA-DC24-HP 24" DC CONNECTOR

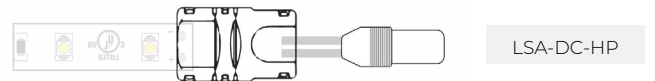

LSA-TB

SOLDERLESS LED STRIP/ WIRE BLOCK CONNECTOR

- LSA-TB-HWC-2A 2 AMP MAX HARDWIRE CONNECTOR
36W MAX (12V) | 72W MAX (24V)
(0.53" X 0.45" X 0.26")



- LSA-TB-HWC-4A 4 AMP MAX HARDWIRE CONNECTOR
36W MAX (12V) | 72W MAX (24V)
(0.45" X 0.48" X 0.31")



- LSA-TB-MC-4A 4 AMP MAX STRIP TO STRIP CONNECTOR
36W MAX (12V) | 72W MAX (24V)
(0.45" X 0.48" X 0.31")



LSM-30

3W INDOOR FLEXIBLE LED STRIP

COMPATIBLE ALUMINUM PROFILES

SURFACE PROFILES

ALU-SF

LENGTHS 39" | 78" | 84" | 98"
LENS Clear, Frosted
FINISH Black | Silver

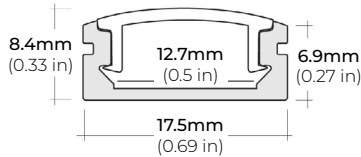

ALU-CN (CORNER)

LENGTHS 39" | 78" | 84" | 96"
LENS Clear, Frosted
FINISH Black | Silver

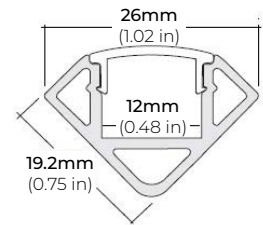

ALU-DS100

LENGTHS 39" | 78" | 84"
LENS Clear, Frosted
FINISH Silver

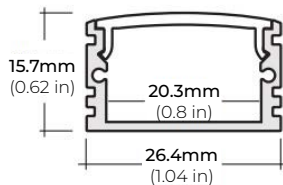

ALP-20

LENGTHS 49" | 84" | 98"
LENS Frosted
FINISH White | Black | Silver

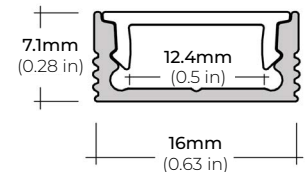

ALP-35

LENGTHS 49" | 98"
LENS Frosted
FINISH White | Black | Silver

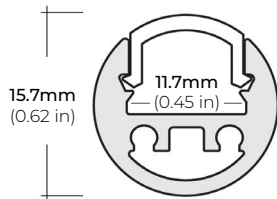

ALP-50C-V2 (CORNER)

LENGTHS 48" | 84" | 98"
LENS Frosted
FINISH White | Black | Silver

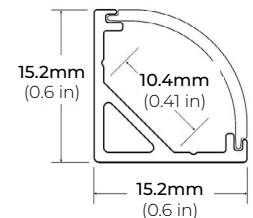

ALP-60

LENGTHS 49" | 84" | 98"
LENS Frosted
FINISH White | Black | Silver

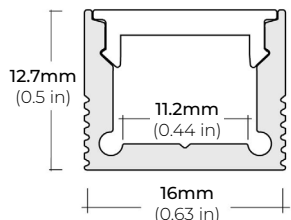

ALP-65

LENGTHS 48" | 96"
LENS Clear
FINISH Silver

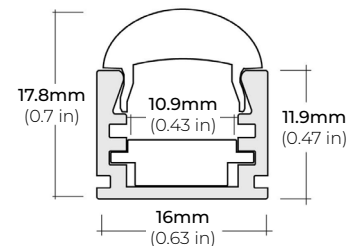

ALP-70

LENGTHS 49" | 84" | 98"
LENS Frosted
FINISH White | Black | Silver

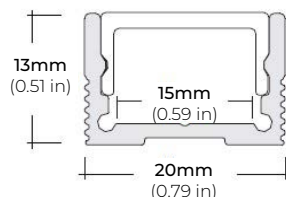

ALP-80

LENGTHS 49" | 98"
LENS Frosted
FINISH Silver

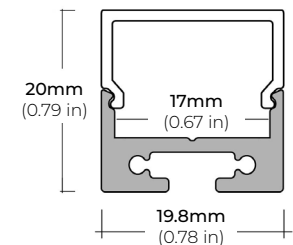

* For more compatible profiles, visit corelightingusa.com

RECESSED PROFILES

ALP-20R

LENGTHS 49" | 98"
LENS Frosted
FINISH White | Black | Silver

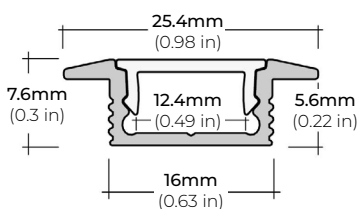

ALP-60R

LENGTHS 49" | 84" | 98"
LENS Frosted
FINISH White | Black | Silver

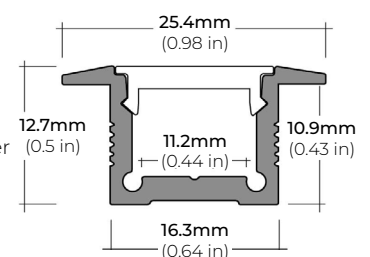

* For more compatible profiles, visit corelightingusa.com

LSM-30

3W INDOOR FLEXIBLE LED STRIP

COMPATIBLE TRANSFORMERS

PSDL SERIES TRIAC DIMMABLE

PSDL-30W-12V	CLASS 2	6.5" X 3.63" X 1.58"
PSDL-60W-12V	CLASS 2	7.4" X 3.63" X 1.58"
PSDL-100W-12V	CLASS 2	8.67" X 3.67 X 1.62"
PSDL-150W-12V		10.25" X 4.06" X 1.82"
PSDL-200W-12V		10.25" X 4.06" X 1.82"
PSDL-300W-12V		10.25" X 4.06" X 1.82"

PSDL-30W-24V	CLASS 2	6.5" X 3.63" X 1.58"
PSDL-60W-24V	CLASS 2	7.4" X 3.63" X 1.58"
PSDL-96W-24V	CLASS 2	8.67" X 3.67 X 1.62"
PSDL-150W-24V		10.25" X 4.06" X 1.82"
PSDL-192W-24V	CLASS 2	11" X 4" X 1.82"
PSDL-200W-24V		10.25" X 4.06" X 1.82"
PSDL-288W-24V	CLASS 2	11.85" X 4.25" X 1.82"
PSDL-300W-24V		10.25" X 4.06" X 1.82"

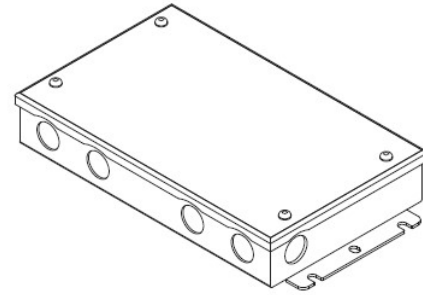

PSDH SERIES HIGH PERFORMANCE MAGNETIC LOW VOLTAGE (MLV)

PSDH-48W-24V	CLASS 2	11.25" X 3.38" X 3.38"
PSDH-96W-24V	CLASS 2	11.25" X 3.38" X 3.37"
PSDH-288W-24V	CLASS 2	14.25" X 8.43" X 4.43"

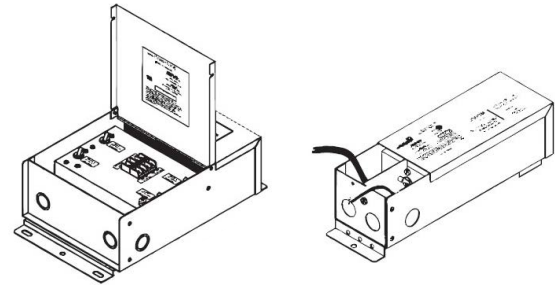

PSRX SERIES 4-IN-1 DIMMING DRIVER W/ JUNCTION BOX

PSRX-30W-12V-UNV	CLASS 2	6.5" X 3.72" X 1.57"
PSRX-60W-12V-UNV	CLASS 2	7.4" X 3.72" X 1.57"
PSRX-150W-12V-UNV		10.24" X 4.13" X 1.77"

PSRX-30W-24V-UNV	CLASS 2	6.5" X 3.7" X 1.57"
PSRX-60W-24V-UNV	CLASS 2	7.4" X 3.72" X 1.57"
PSRX-96W-24V-UNV	CLASS 2	8.66" X 3.72" X 1.57"
PSRX-150W-24V-UNV		10.24" X 4.13" X 1.77"
PSRX-200W-24V-UNV		10.24" X 4.13" X 1.77"
PSRX-300W-24V-UNV		10.94" X 4.33" X 1.77"

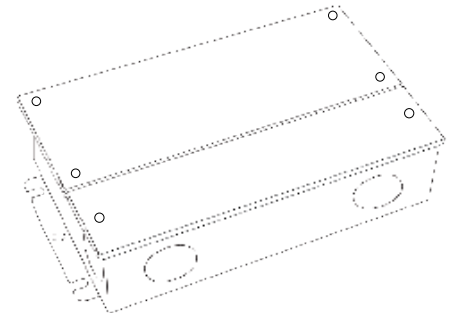

LSM-30

3W INDOOR FLEXIBLE LED STRIP

COMPATIBLE TRANSFORMERS

PSVT SERIES

0-10V DIMMING WITH JUNCTION BOX

PSVT-60W-24V-UNV-010	CLASS 2	7.4" X 3.72" X 1.57"
PSVT-96W-24V-UNV-010	CLASS 2	8.66" X 3.72" X 1.57"
PSVT-200W-24V-UNV-010		10.24" X 4.13" X 1.77"
PSVT-288W-24V-UNV-010	CLASS 2	11.85" X 4.25" X 1.81"
PSVT-300W-24V-UNV-010		10.94" X 4.33" X 1.77"

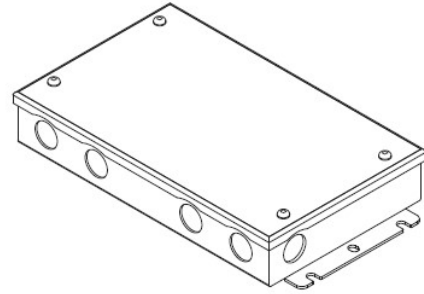

PSDE SERIES

0-10V DIMMING W/ JUNCTION BOX

PSDE-60W-24V-010-JB	CLASS 2	12.1" X 2.36" X 1.4"
PSDE-96W-24V-010-JB	CLASS 2	12.1" X 2.36" X 1.4"

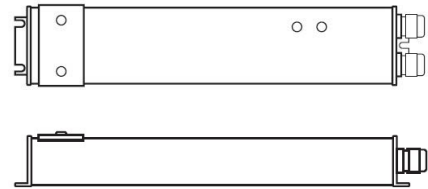

LUTRON 1%

3-WIRE DIMMING

L3DA4U1UKL-CV240	CLASS 2	4.89" X 4" X 2.62"
------------------	---------	--------------------

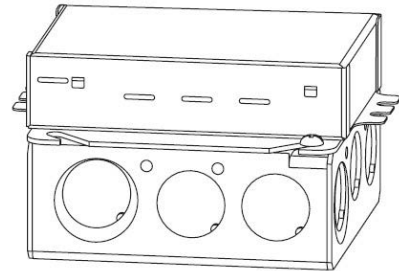

LUTRON 1%

PSDE-96W-24V-ECO	CLASS 2	10.5" X 3.0" X 2.0"
------------------	---------	---------------------

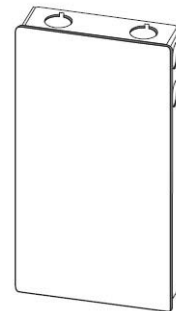

LSM-30

3W INDOOR FLEXIBLE LED STRIP

COMPATIBLE NON-DIMMING DRIVERS

PSHK SERIES

NON-DIMMING CONSTANT VOLTAGE WITH JUNCTION BOX

PSHK-30W-24V	CLASS 2	6.5" X 3.6" X 1.02"
PSHK-60W-24V	CLASS 2	7.4" X 3.62" X 1.02"
PSHK-96W-24V	CLASS 2	8.66" X 3.66" X 1.61"
PSHK-150W-24V		10.24" X 4.06" X 1.81"
PSHK-200W-24V		10.24" X 4.06" X 1.81"
PSHK-288W-24V	CLASS 2	11.85" X 4.25" X 1.82"
PSHK-300W-24V		10.94" X 4.25" X 1.81"

