

# USB SERIES

## 5W 24V PREMIUM DIFFUSION LIGHT BAR

Project \_\_\_\_\_  
Location \_\_\_\_\_  
Quote/ Ref # \_\_\_\_\_

**USB Lightbar** is a linkable LED light source with a patented diffused optical lens for perfect even illumination without any hot spots. Delivering 320 Lumens per foot, the USB lightbar is one of the brightest and most efficient LED linear systems available to date. At only 5W per foot, the USB Lightbar is a great alternative to halogen linear systems providing over 50,000 hours of light source.



### SPECIFICATIONS

INPUT VOLTAGE	24V DC Constant Voltage
POWER CONSUMPTION	4.8W/ Ft.
LUMEN OUTPUT	320 Lm.
CRI	90+
LED	2835
COLOR TEMPERATURE	30K/ 40K
DIMMING	MLV, ELV, 0-10V and TRIAC
MAXIMUM RUN LENGTH	Linkable up to 20Ft.
MOUNTING	Surface
IP RATING	IP20
CERTIFICATIONS	ETL
LUMEN MAINTENANCE	50,000 Hrs.

### FEATURES

- 24V DC Constant Voltage Input
- 320 Lumens/ Ft.
- Dimmable (with CORE LED dimmable drivers)
- 6" to 48" Length Options
- Includes Flat Mounting Brackets and Mini Coupling

### LUMENS

MODEL	LENGTH	WATTS	LM/FT.	NO. LEDS
USB-6	6"	2.5W	160	24
USB-12	12"	5W	320	48
USB-24	24"	10W	640	96
USB-36	36"	15W	960	144
USB-48	48"	20W	1280	192

\*Approved for closet / storage space installation per NEC 410.16(A)(3) and 410.16(C)(5)



MODEL	LENGTH	COLOR TEMP	FINISH	VOLTAGE
USB	6 6 in.	30K 3000K	SI Silver	24 24V DC
	12 12 in.	40K 4000K		
	24 24 in.			
	36 36 in.			
	48 48 in.			

# USB SERIES

## 5W 24V PREMIUM DIFFUSION LIGHT BAR

### DIMENSIONS

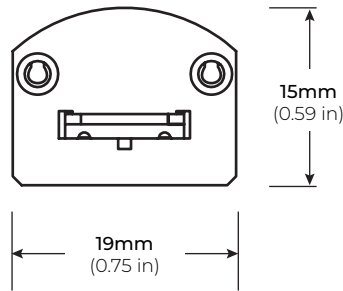

### COMPATIBLE ACCESSORIES

#### USB-BKT

FLAT MOUNTING BRACKET  
\* INCLUDED WITH EVERY FIXTURE



#### USB-BKT-45

45° MOUNTING BRACKET



#### USB-BKT-ADJ

SWIVEL MOUNTING BRACKET

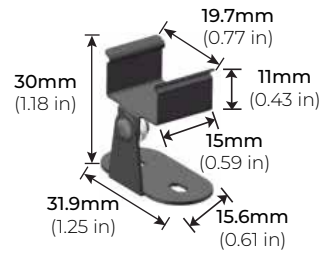

#### INLINE TOUCH DIMMER

##### USB-DM

MAX LOAD: 4A  
2.17" X 0.75" X 0.59" (LXWXH)

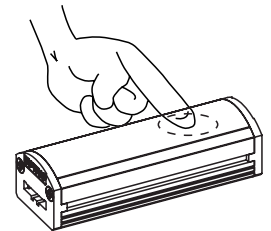

#### INLINE MOTION SENSOR

##### USB-MS

MAX LOAD: 4A  
2.48" X 0.75" X 0.7" (LXWXH)

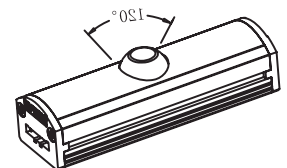

# USB SERIES

## 5W 24V PREMIUM DIFFUSION LIGHT BAR

### COMPATIBLE ACCESSORIES

#### MOTION SENSOR

LSA-DC-MS  
MOTION SENSOR



#### MINI COUPLING

USB-MC  
MINI COUPLING  
\* INCLUDED WITH EVERY FIXTURE



#### LINK EXTENSION CABLE

USB-LNK-2      2" LINK CABLE  
USB-LNK-6      6" LINK CABLE  
USB-LNK-24     24" LINK CABLE

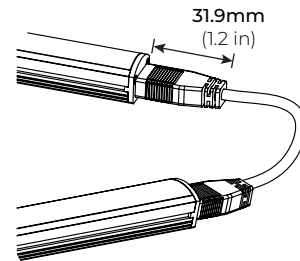

#### HARDWIRE CABLE

USB-HWC-12     12" HARDWIRE CABLE  
USB-HWC-72     72" HARDWIRE CABLE

USB-HWC-12L    12" SIDE POWER HARDWIRE CABLE  
USB-HWC-72L    72" SIDE POWER HARDWIRE CABLE

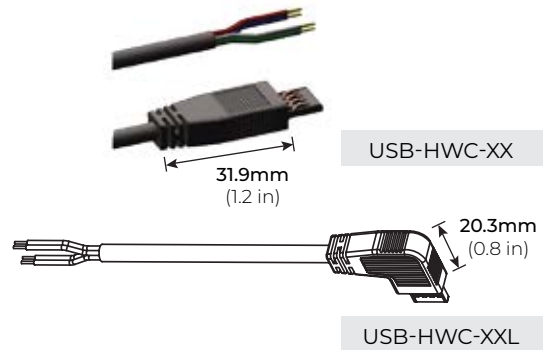

#### DC POWER CONNECTOR

USB-PDC-12     12" PLUGIN CABLE

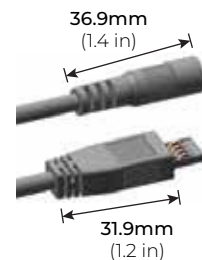

# USB SERIES

## 5W 24V PREMIUM DIFFUSION LIGHT BAR

### COMPATIBLE TRANSFORMERS

#### PSDL SERIES TRIAC DIMMABLE

PSDL-30W-24V	CLASS 2	6.5" X 3.63" X 1.03"
PSDL-60W-24V	CLASS 2	7.4" X 3.63" X 1.03"
PSDL-96W-24V	CLASS 2	8.67" X 3.67 X 1.62"
PSDL-150W-24V		8.67" X 3.67" X 1.62"
PSDL-192W-24V	CLASS 2	10.25" X 4.06" X 1.82"
PSDL-200W-24V		10.25" X 4.06" X 1.82"
PSDL-288W-24V	CLASS 2	10.25" X 4.06" X 1.82"
PSDL-300W-24V		10.25" X 4.06" X 1.82"

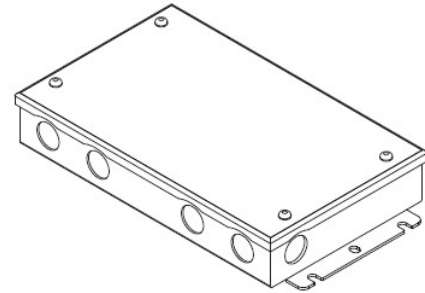

#### PSDH SERIES HIGH PERFORMANCE MAGNETIC LOW VOLTAGE (MLV)

PSDH-48W-24V	CLASS 2	11.25" X 3.37" X 3.25"
PSDH-96W-24V	CLASS 2	11.25" X 3.37" X 3.25"
PSDH-288W-24V	CLASS 2	14.25" X 8.43" X 4.43"

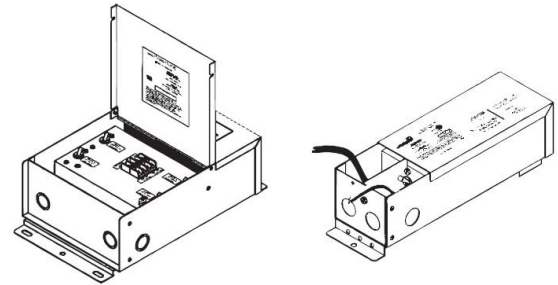

#### PSRX SERIES 4-IN-1 DIMMING DRIVER

PSRX-30W-24V	CLASS 2	6.5" X 3.72" X 1.57"
PSRX-60W-24V	CLASS 2	7.4" X 3.72" X 1.57"
PSRX-96W-24V	CLASS 2	8.66" X 3.72" X 1.57"
PSRX-150W-24V		10.24" X 4.13" X 1.77"
PSRX-192W-24V	CLASS 2	11" X 4" X 1.82"
PSRX-200W-24V		10.24" X 4.13" X 1.77"
PSRX-288W-24V	CLASS 2	11.85" X 4.25" X 1.82"
PSRX-300W-24V		10.94" X 4.33" X 1.77"

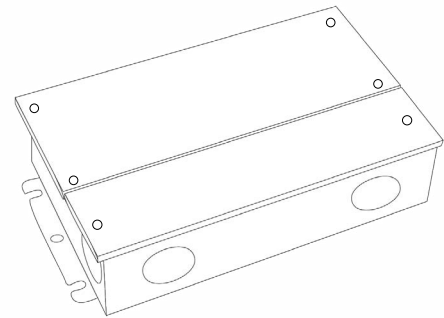

#### PSVT SERIES 0-10V DIMMING DRIVER

PSVT-60W-24V	CLASS 2	7.4" X 3.72" X 1.57"
PSVT-96W-24V	CLASS 2	8.66" X 3.72" X 1.57"
PSVT-200W-24V		10.24" X 4.13" X 1.77"
PSVT-288W-24V	CLASS 2	11.85" X 4.25" X 1.81"
PSVT-300W-24V		10.94" X 4.33" X 1.77"

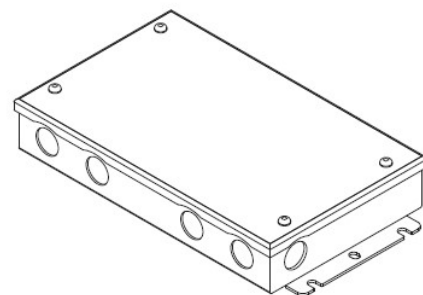

# USB SERIES

## 5W 24V PREMIUM DIFFUSION LIGHT BAR

### COMPATIBLE TRANSFORMERS

#### PSDE SERIES

0-10V DIMMING W/ JUNCTION BOX

PSDE-60W-24V-010-JB	CLASS 2	12.1" X 2.36" X 1.4"
PSDE-96W-24V-010-JB	CLASS 2	12.1" X 2.36" X 1.4"

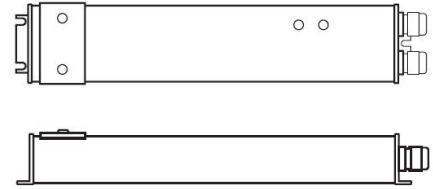

#### LUTRON 1%

3-WIRE DIMMING

L3DA4U1UKL-CV240	CLASS 2	4.89" X 4" X 2.62"
------------------	---------	--------------------

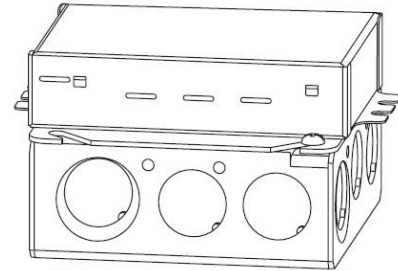

PSDE-96W-24V-ECO	CLASS 2	10.5" X 3.0" X 2.0"
------------------	---------	---------------------

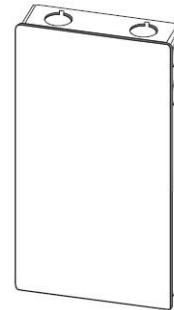

### COMPATIBLE NON-DIMMING DRIVERS

#### PSHK SERIES

NON-DIMMING CONSTANT VOLTAGE WITH JUNCTION BOX

PSHK-30W-24V	CLASS 2	6.5" X 3.6" X 1.02"
PSHK-60W-24V	CLASS 2	7.4" X 3.62" X 1.02"
PSHK-96W-24V	CLASS 2	8.66" X 3.66" X 1.61"
PSHK-150W-24V		10.24" X 4.06" X 1.81"
PSHK-200W-24V		10.24" X 4.06" X 1.81"
PSHK-288W-24V	CLASS 2	11.85" X 4.25" X 1.82"
PSHK-300W-24V		10.24" X 4.25" X 1.81"

