

SLINQ RGB

RGB FLEXIBLE 360° ROUND NEON SERIES

Project _____

Location _____

Quote/ Ref # _____

Slinq RGB— IP65 rated, flexible neon rope light is a true game-changer, with its 360° illuminating capabilities and vibrant RGB color options. Unleash your creativity to create any desired shape, freeform pattern, grid, icicle chandeliers, or simply drape it along walls and ceilings. Perfect for any project, whether you're looking to create an eye-catching centerpiece or simply add some ambiance to your living space.

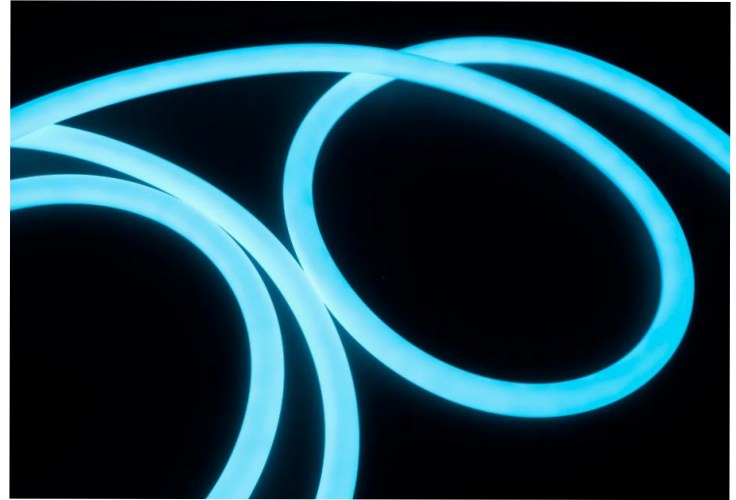

SPECIFICATIONS

| | |
|-----------------------|------------------------------|
| POWER CONSUMPTION | 4.4W per foot |
| LUMEN OUTPUT | 317 Lm/ Ft. |
| CRI | 90+ |
| COLOR TEMPERATURE | RGB |
| MAXIMUM RUN LENGTH | 16 Ft. |
| OPERATING VOLTAGE | 24V |
| STORAGE TEMPERATURE | -30°C to 60°C |
| OPERATING TEMPERATURE | 30°C (-22°F) to 55°C (131°F) |
| BEAM ANGLE | 360° |
| IP RATING | IP65 Outdoor/ Wet Location |
| LUMEN MAINTENANCE | 50,000 Hrs. |

FEATURES

- 360° Light Source
- Multiple Mounting Options
- DMX Control
- IP65 Outdoor Rated
- Factory-Installed Power Feed
- Injection Moulded End-Caps
- Ideal for Decorative, Retail, Artistic Lighting



| MODEL | LENGTH | COLOR TEMP | VOLTAGE | MOUNTING OPTIONS | POWER FEED |
|--------|----------------------|------------|-----------------|-------------------------------------|-----------------------|
| SLQ-25 | Per Inch Per Inch | RGB RGB | 24V 24 Volts | AR Arch | EF72 72" End Feed |
| | | | | SF Surface Pendant | SF72 72" Side Feed |
| | | | | SUP Suspended Pendant | |
| | | | | SCS Suspension Cable Support | |
| | | | | TES Telescopic Extension Support | |

SLINQ RGB

RGB FLEXIBLE 360° ROUND NEON SERIES

MOUNTING OPTIONS

ARCH (AR)

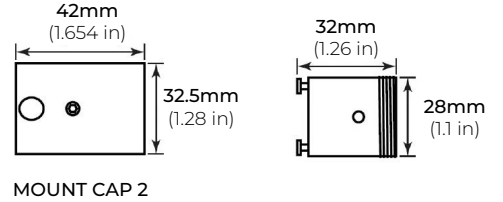
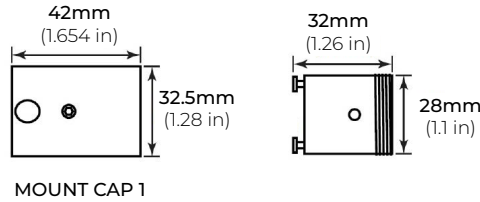
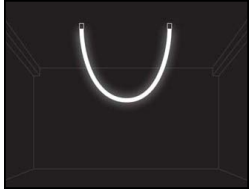

SURFACE PENDANT (SF)

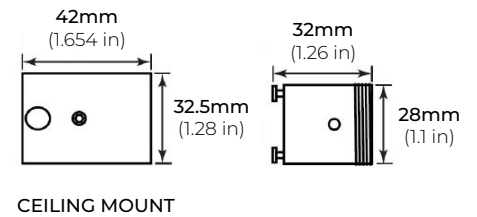
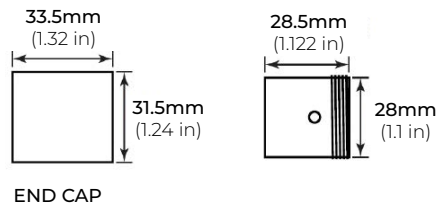
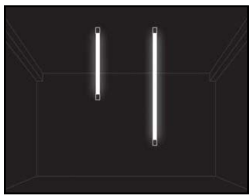

SUSPENDED PENDANT (SUP)

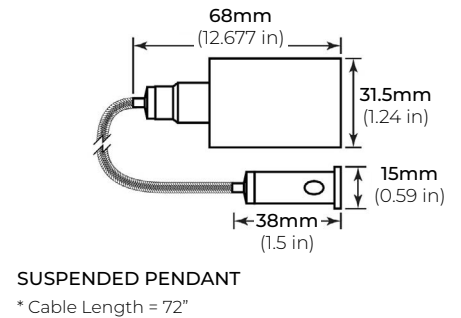
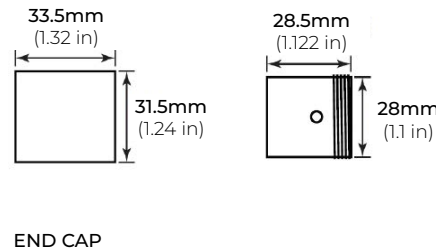
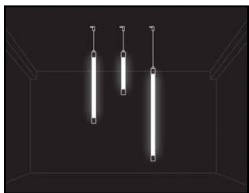

SUSPENSION CABLE SUPPORT (SCS)

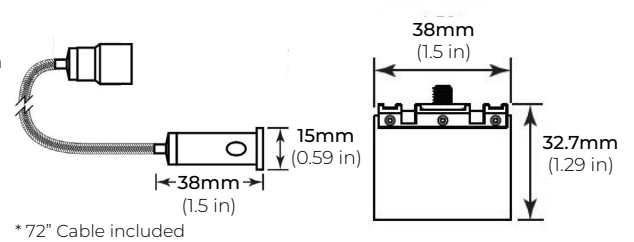
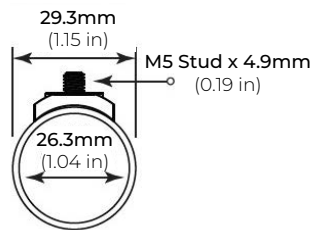
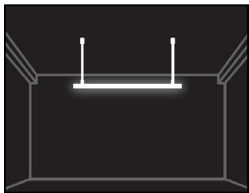

TELESCOPIC EXTENSION SUPPORT (TES)

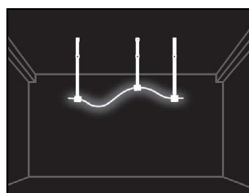

* 13 - 24" Extension

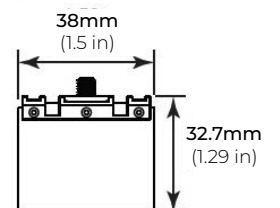
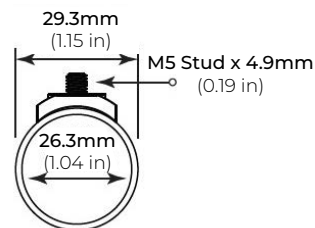

SLINQ RGB

RGB FLEXIBLE 360° ROUND NEON SERIES

ACCESSORIES

VISIBLE MOUNTING CLIP (VMC)

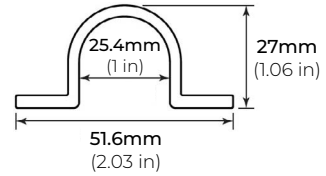

DISCREET MOUNTING BRACKET (DMB)

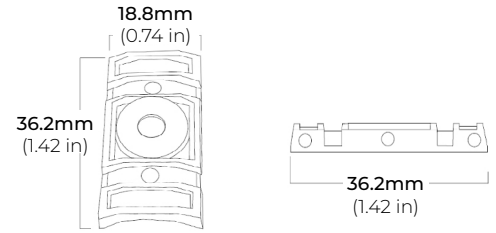

INFINITY JOINER (IJ)

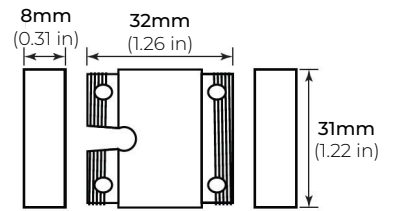
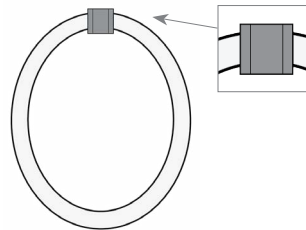

SLQ25-RTS-39-S
39" RIGID TUBE

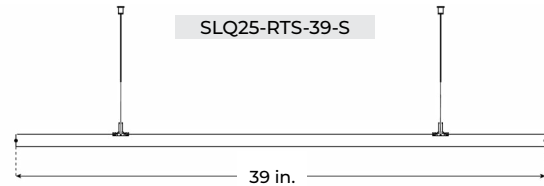

SLQ25-RTS-78-S
78" RIGID TUBE

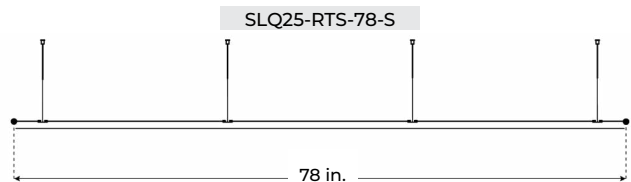

DIMENSIONS

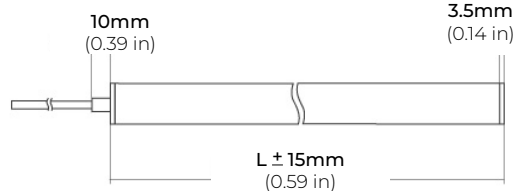
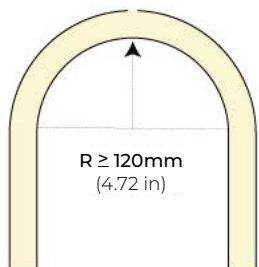

END FEED

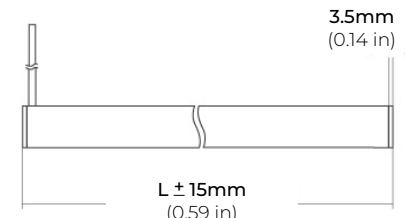

SIDE FEED

SLINQ RGB

RGB FLEXIBLE 360° ROUND NEON SERIES

DMX CONTROLLERS

RGB CT600

MULTI-FUNCTION RGBW WALL CONTROLLER

| | |
|---------------|---------------------------|
| INPUT VOLTAGE | 5V DC, 1A |
| OUTPUT SIGNAL | RF 2.4GHZ + DMX512 |
| CONTROL | 4 ZONES |
| COLOR OPTIONS | Black/ White |
| WORKING TEMP | -20°C ~ 40°C |
| DIMENSIONS | LxWxH (5.19"x7.08"x1.38") |

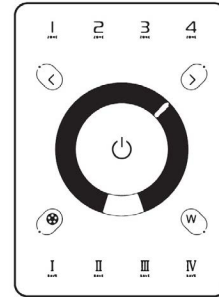

RGB-SCW4

WiFi DMX WALL CONTROLLER

| | |
|-----------------|--|
| INPUT VOLTAGE | 5 - 10V DC, 06A |
| OUTPUT SIGNAL | DMX512 (x2) |
| PROGRAMMABILITY | PC/ MAC |
| COLOR OPTIONS | Black/ White |
| CONNECTIONS | USB/ 8dry contact ports/ Open drain output (for relay) |
| MEMORY | Built-In Flash |
| WORKING TEMP | -10°C ~ 45°C |
| DIMENSIONS | LxWxH (5.75"x4.17"x0.43") |

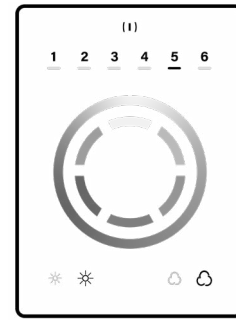

RGB-SDE3

WiFi DMX WALL CONTROLLER

| | |
|-----------------|--|
| INPUT VOLTAGE | 6V DC, 0.6A |
| OUTPUT SIGNAL | DMX512 (x2) |
| PROGRAMMABILITY | PC/ MAC/ Tablet/ Smartphone |
| COLOR OPTIONS | Black/ White |
| CONNECTIONS | USB/ Ethernet/ RS232/ CLock/ 8dry contact ports/ 5V output relay |
| MEMORY | MicroSD Card |
| WORKING TEMP | -20°C ~ 40°C |
| DIMENSIONS | LxWxH (5.75"x4.17"x0.43") |

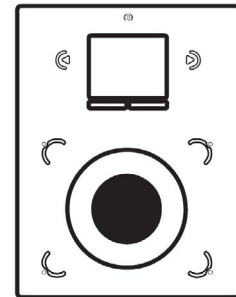

SLINQ RGB

RGB FLEXIBLE 360° ROUND NEON SERIES

DMX DECODERS

RGB-DMX-4C-RJ45 4-CHANNEL DMX DECODER

| | |
|-----------------|------------------------|
| INPUT VOLTAGE | 12V-24V DC |
| OUTPUT CURRENT | 5A X 4CH |
| OUTPUT WATTAGE | 60W(12V), 120W(24V) |
| OUTPUT CHANNELS | 4 |
| DIMENSIONS | LxWxH (7"x1.77"x0.75") |

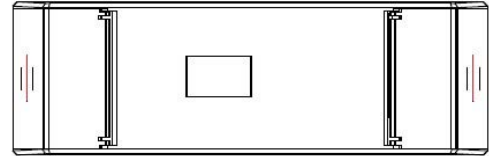

RGB-DMX-5C-XLR 5-CHANNEL DMX DECODER

| | |
|-----------------|--------------------------|
| INPUT VOLTAGE | 12V-24V DC |
| OUTPUT CURRENT | 8A X 5CH |
| OUTPUT WATTAGE | 5 x (96W ~ 192W) |
| OUTPUT CHANNELS | 5 |
| DIMENSIONS | LxWxH (6.45"x2.87"x1.5") |

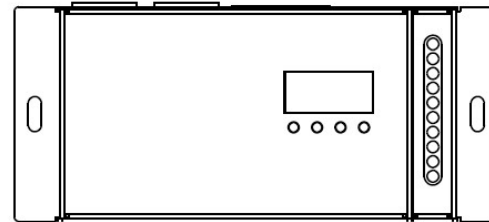

SLINQ RGB

RGB FLEXIBLE 360° ROUND NEON SERIES

NON-DMX CONTROLLERS

RGB-CT550

RGBW WIRELESS RECEIVER / CONTROLLER SYSTEM

| | |
|-----------------|---------------------------|
| REMOTE DISTANCE | 100 Ft. (Line of Sight) |
| FREQUENCY | 2.4 GHz |
| DIMENSIONS | LxWxH (6.38"x1.65"x0.59") |
| WEIGHT | 0.44lbs. |

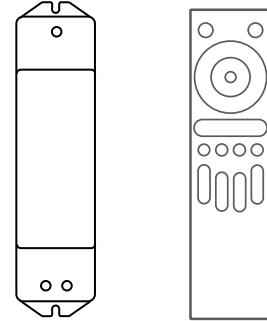

* RGB-CT500-RX
(Sold Separately)

RGB-CT550-RX

RGBW WIRELESS RECEIVER / CONTROLLER SYSTEM

| | |
|----------------|-------------------------------------|
| INPUT VOLTAGE | DC5V ~ DC24V |
| POWER CAPACITY | 100W (5V) 240W (12V) 480W (24V) |
| OUTPUT CURRENT | 5A per Channel (20A Total) |
| WORKING TEMP | -30°C~55°C (-22°F~131°F) |
| DIMENSIONS | LxWxH (6.89"x1.73"x1.18") |

* RGB-CT500-RX (Sold Separately)

RGB-CT700

MASTER RGBW WIFI CONTROLLER

| | |
|----------------|-----------------------------|
| INPUT VOLTAGE | 12-24V DC |
| OUTPUT TYPE | Constant Voltage |
| POWER CAPACITY | 288W (12V) 384W (24V) |
| OUTPUT CURRENT | 5A per Channel (20A Total) |
| WORKING TEMP | -4°F (-20°C) ~ 122°F (50°C) |
| DIMENSIONS | LxWxH (7 x1.8 x 0.8") |

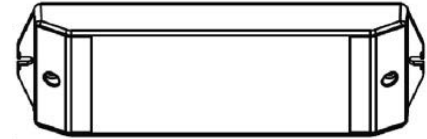

* Paired with RGB-CT705ZR (Sold Separately)

RGB-CT705ZR

SLAVE RGBW WIFI CONTROLLER

| | |
|----------------|-----------------------------|
| INPUT VOLTAGE | 12-24V DC |
| OUTPUT TYPE | Constant Voltage |
| POWER CAPACITY | 288W (12V) 384W (24V) |
| OUTPUT CURRENT | 5A per Channel (20A Total) |
| WORKING TEMP | -4°F (-20°C) ~ 122°F (50°C) |
| DIMENSIONS | LxWxH (7 x0,63 x 0.71") |

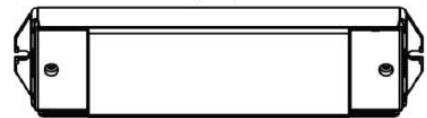

* Paired with RGB-CT700 (Sold Separately)

SLINQ RGB

RGB FLEXIBLE 360° ROUND NEON SERIES

NON-DMX CONTROLLERS (CONTINUED)

RGB-CT840 BLUETOOTH TOUCH PANEL WALL CONTROLLER

| | |
|-------------------|------------------------|
| INPUT VOLTAGE | 12-24V DC |
| ZONES | 4 |
| CONTROL MODE | RGB RGBW |
| WIRELESS PROTOCOL | Bluetooth 5.0 SIG Mesh |
| WORKING TEMP | -20°C ~ 55°C |
| DIMENSIONS | LxWxH (4.7"x3"x1.2") |

** Paired with RGB-CT800-RC (Sold Separately)*



RGB-CT800-RC BLUETOOTH CONSTANT VOLTAGE LED RECEIVER

| | |
|-----------------|---------------------------|
| INPUT VOLTAGE | 12V 24V |
| OUTPUT CURRENT | 4Ax5CH / 5Ax4CH (20A Max) |
| POWER CAPACITY | 240W (12V) 480W (24V) |
| PROGRAMMABILITY | iOS and Android |
| WORKING TEMP | -20°C ~ 55°C |
| DIMENSIONS | LxWxH (6.9 x1.7 x 1.2") |

** Paired with RGB-CT840 (Sold Separately)*



SLINQ RGB

RGB FLEXIBLE 360° ROUND NEON SERIES

NON-DIMMING DRIVERS (COMPATABLE WITH ALL SYSTEMS)

PSHK SERIES

NON-DIMMING CONSTANT VOLTAGE WITH JUNCTION BOX

| | | |
|---------------|---------|------------------------|
| PSHK-30W-24V | CLASS 2 | 6.5" X 3.6" X 1.02" |
| PSHK-60W-24V | CLASS 2 | 7.4" X 3.62" X 1.02" |
| PSHK-96W-24V | CLASS 2 | 8.66" X 3.66" X 1.61" |
| PSHK-150W-24V | | 10.24" X 4.06" X 1.81" |
| PSHK-200W-24V | | 10.24" X 4.06" X 1.81" |
| PSHK-288W-24V | CLASS 2 | 11.85" X 4.25" X 1.82" |
| PSHK-300W-24V | | 10.24" X 4.25" X 1.81" |

