

# LSRE-40

## 4.4W IP67 FLEXIBLE LED NEON SERIES

Project \_\_\_\_\_  
Location \_\_\_\_\_  
Quote/ Ref # \_\_\_\_\_

The **LSRE-40** is a high performance flexible and affordable LED fixture designed as a neon replacement and is also useful in a wide variety of indoor or outdoor applications where a smooth surface or continuous line of light is desired. It is a flexible strip light that can bend around contours or tight curves vertically without being damaged.



### SPECIFICATIONS

POWER CONSUMPTION	4.4W per Ft.
LUMEN OUTPUT	178 Lumens per Ft.
CRI	95+
COLOR TEMPERATURE	27K/ 30K/ 35K/ 40K
DIMMING/ CONTROL	MLV, ELV, 0-10 and TRIAC
MAXIMUM RUN LENGTH	16 Ft.
CUTTABLE	Every 3.94 in. (100mm)
OPERATING VOLTAGE	24V DC
STORAGE TEMPERATURE	-40°F (-40°C) to 176°F (80°C)
OPERATING TEMPERATURE	-4°F (-20°C) to 113°F (45°C)
BEAM ANGLE	110°
IP RATING	IP67
CERTIFICATIONS	UL Listed, CE, RoHS
LUMEN MAINTENANCE	50,000 Hrs.

### FEATURES

- High color consistency and smooth illumination
- Multiple CCT options available
- Continuous run length up to 16 Ft.
- Cuttable every 3.94 in. (100mm)
- Bottom, Side and End Feed options
- UL Listed, CE and RoHS



MODEL	LIGHT SURFACE	COLOR TEMP	VOLTAGE	LENGTH	POWER FEED	FEED LENGTH
LSRE-40	VB Vertical Bend	<b>27K</b> 2700K	<b>24</b> 24V DC	1'XX per Ft.	<b>IP67BF</b> Bottom Feed	<b>HW3</b> 3 Ft. Power Feed
		<b>30K</b> 3000K			<b>IP67SFL</b> Side Feed Left	<b>HW10</b> 10 Ft. Power Feed
		<b>35K</b> 3500K			<b>IP67SFR</b> Side Feed Right	<b>HW15</b> 15 Ft. Power Feed
		<b>40K</b> 4000K			<b>IP67EF</b> End Feed	
				*1 = Custom length per FT. (cuttable every 3.94")		

# LSRE-40

## 4.4W IP67 FLEXIBLE LED NEON SERIES

### DIMENSIONS

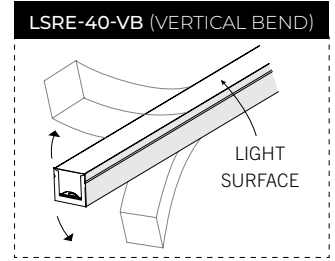
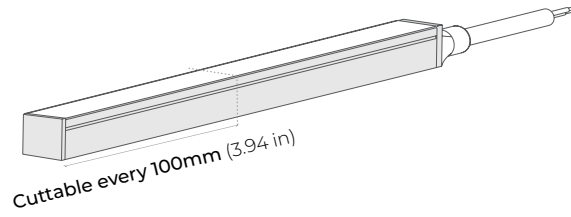
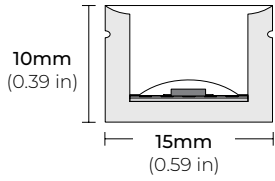

### COMPATIBLE ACCESSORIES

#### MOUNTING ALUMINUM PROFILE

LSRE-40-AC2  
2" PROFILE

LSRE-40-AC39  
39" PROFILE

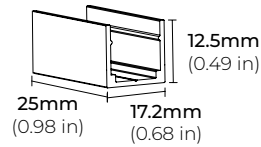

LSRE-40-AC2

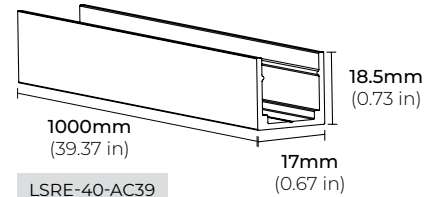

LSRE-40-AC39

### IP67 POWER FEED

IP67BF  
BOTTOM FEED

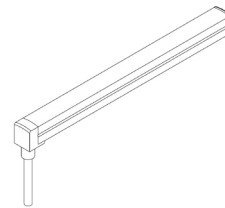

IP67FL  
SIDE LEFT FEED

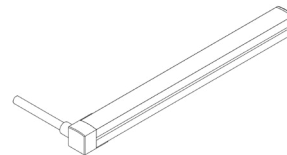

IP67FR  
SIDE RIGHT FEED

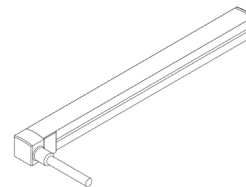

IP67EF  
END FEED

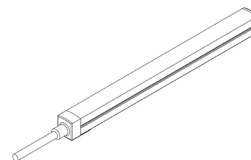

# LSRE-40

## 4.4W IP67 FLEXIBLE LED NEON SERIES

### COMPATIBLE TRANSFORMERS

#### PSDL SERIES TRIAC DIMMABLE

PSDL-30W-24V	CLASS 2	6.5" X 3.63" X 1.03"
PSDL-60W-24V	CLASS 2	7.4" X 3.63" X 1.03"
PSDL-96W-24V	CLASS 2	8.67" X 3.67" X 1.62"
PSDL-150W-24V		8.67" X 3.67" X 1.62"
PSDL-192W-24V	CLASS 2	10.25" X 4.06" X 1.82"
PSDL-200W-24V		10.25" X 4.06" X 1.82"
PSDL-288W-24V	CLASS 2	10.25" X 4.06" X 1.82"
PSDL-300W-24V		10.25" X 4.06" X 1.82"

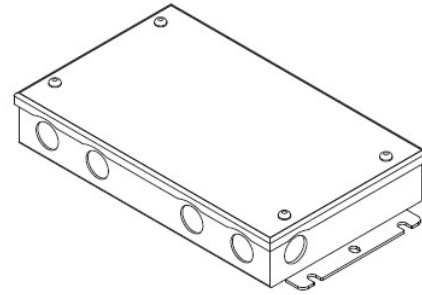

#### PSDH SERIES HIGH PERFORMANCE MAGNETIC LOW VOLTAGE (MLV)

PSDH-48W-24V	CLASS 2	11.25" X 3.37" X 3.25"
PSDH-96W-24V	CLASS 2	11.25" X 3.37" X 3.25"
PSDH-288W-24V	CLASS 2	14.25" X 8.43" X 4.43"

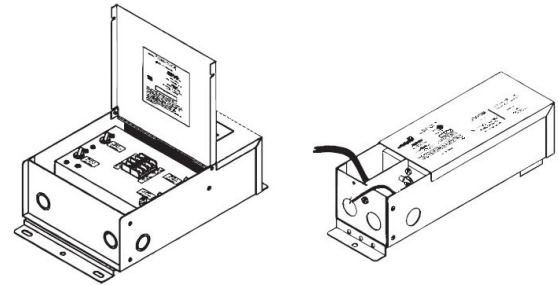

#### PSRX SERIES 4-IN-1 DIMMING DRIVER

PSRX-30W-24V	CLASS 2	6.5" X 3.72" X 1.57"
PSRX-60W-24V	CLASS 2	7.4" X 3.72" X 1.57"
PSRX-96W-24V	CLASS 2	8.66" X 3.72" X 1.57"
PSRX-150W-24V		10.24" X 4.13" X 1.77"
PSRX-192W-24V	CLASS 2	11" X 4" X 1.82"
PSRX-200W-24V		10.24" X 4.13" X 1.77"
PSRX-288W-24V	CLASS 2	11.85" X 4.25" X 1.82"
PSRX-300W-24V		10.94" X 4.33" X 1.77"

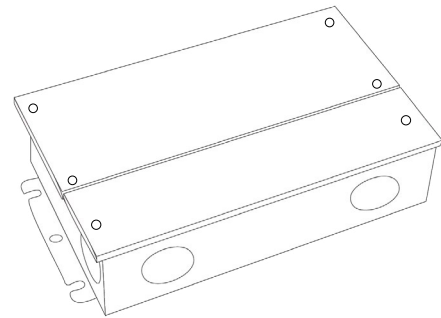

#### PSVT SERIES 0-10V DIMMING DRIVER

PSVT-60W-24V	CLASS 2	7.4" X 3.72" X 1.57"
PSVT-96W-24V	CLASS 2	8.66" X 3.72" X 1.57"
PSVT-200W-24V		10.24" X 4.13" X 1.77"
PSVT-288W-24V	CLASS 2	11.85" X 4.25" X 1.81"
PSVT-300W-24V		10.94" X 4.33" X 1.77"

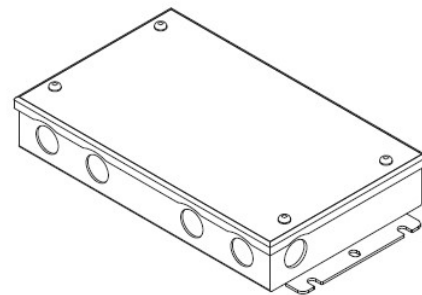

# LSRE-40

## 4.4W IP67 FLEXIBLE LED NEON SERIES

### COMPATIBLE TRANSFORMERS

#### PSDE SERIES

0-10V DIMMING W/ JUNCTION BOX

PSDE-60W-24V-010-JB	CLASS 2	12.1" X 2.36" X 1.4"
PSDE-96W-24V-010-JB	CLASS 2	12.1" X 2.36" X 1.4"

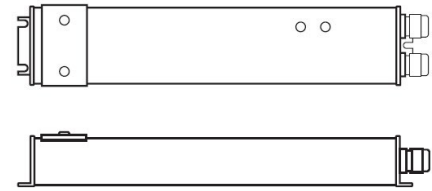

#### LUTRON 1% 3-WIRE DIMMING

L3DA4U1UKL-CV240	CLASS 2	4.89" X 4" X 2.62"
------------------	---------	--------------------

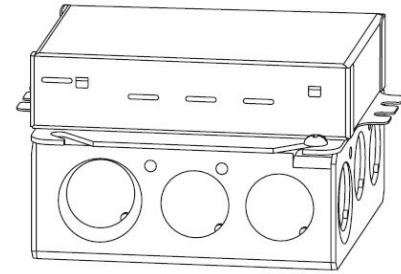

PSDE-96W-24V-ECO	CLASS 2	10.5" X 3.0" X 2.0"
------------------	---------	---------------------

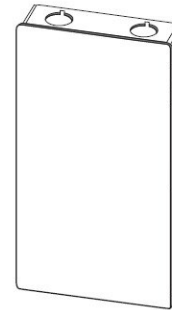

### COMPATIBLE NON-DIMMING DRIVERS

#### PSHK SERIES

NON-DIMMING CONSTANT VOLTAGE WITH JUNCTION BOX

PSHK-30W-24V	CLASS 2	6.5" X 3.6" X 1.02"
PSHK-60W-24V	CLASS 2	7.4" X 3.62" X 1.02"
PSHK-96W-24V	CLASS 2	8.66" X 3.66" X 1.61"
PSHK-150W-24V		10.24" X 4.06" X 1.81"
PSHK-200W-24V		10.24" X 4.06" X 1.81"
PSHK-288W-24V	CLASS 2	11.85" X 4.25" X 1.82"
PSHK-300W-24V		10.24" X 4.25" X 1.81"

