

LSMW-40HF

4.0W OUTDOOR RATED FLEXIBLE LED STRIP

Project _____

Location _____

Quote/ Ref # _____

LSMW-40HF is an outdoor, wet-rated and dimmable flexible LED strip capable of delivering 440 lumens of light output per ft. Rated to last 50,000 hours making it an excellent replacement for traditional halogen lighting. Its low profile design makes it suitable for use in cove lighting, under cabinets, displays, showcases and architectural and aesthetic projects.



SPECIFICATIONS

INPUT VOLTAGE	24V DC
POWER CONSUMPTION	4W/Ft.
NO. OF LEDS	40 LEDs per Ft.
LUMEN OUTPUT	468 Lm/Ft. (3000K)
CRI	95+
COLOR TEMPERATURE	27K / 30K / 35K / 40K / 50K
DIMMING	MLV, ELV, 0-10V and TRIAC
MAXIMUM RUN LENGTH	16 Ft.
CUTTABLE	Every 2.46 in (62.52mm)
BINNING	1.5 Step Macadam Elipse
OPERATING TEMPERATURE	-40°F (-40°C) ~ +140°F (+60°C)
BEAM ANGLE	120°
IP RATING	IP65 wet location (outdoor)
CERTIFICATIONS	UL Listed, TITLE 24 JA8
LUMEN MAINTENANCE	50,000 Hrs.

LUMENS

CCT	LM/ FT	CRI	R9	R13
2700K	468	97	88	99
3000K	468	97	96	98
3500K	497	96	98	96
4000K	507	94	85	97
5000K	532	88	67	92

*Approved for closet / storage space installation per NEC 410.16(A)(3) and 410.16(C)(5)



MODEL	COLOR TEMP	LENGTH	VOLTAGE	PROFILE
LSMW40HF	27K 2700K	16 16 Ft.	24 24V DC	See Page 2 for compatible profiles.
	30K 3000K	25 25 Ft.		
	35K 3500K	32 32 Ft.		
	40K 4000K	1XX per Ft.		
	50K 5000K			

*1 = Custom length per FT.
(Cutttable every 2.46")

* Custom color finishes require powder coating. Allow 7 days leads time.

LSMW-40HF

4.0W OUTDOOR RATED FLEXIBLE LED STRIP

DIMENSIONS

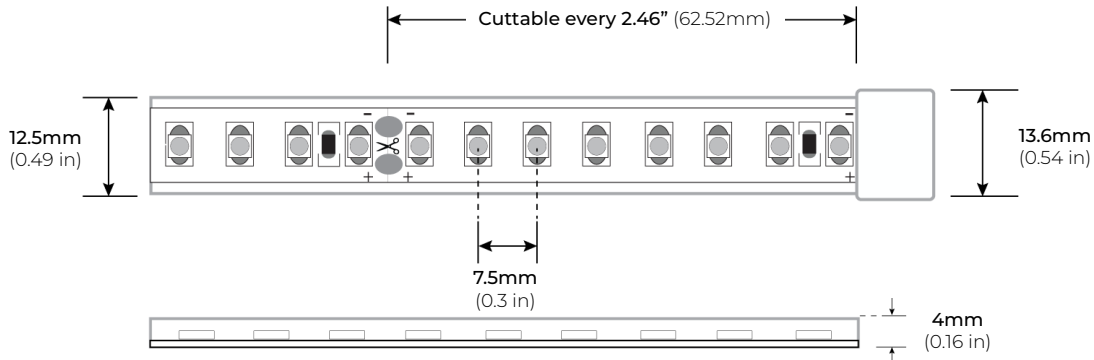

COMPATIBLE ALUMINUM PROFILES

SURFACE PROFILES

ALU-DS100

LENGTHS 39" | 78" | 84"
LENS Clear, Frosted
FINISH Silver

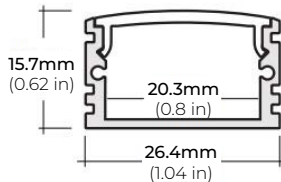

ALP-70

LENGTHS 49.25" | 84" | 98.5"
LENS Frosted
FINISH White | Black | Silver

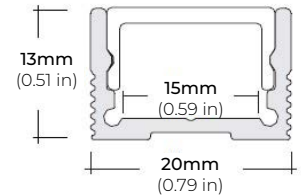

ALP-75C (CORNER)

LENGTHS 49" | 84" | 98"
LENS Frosted
FINISH Black | Silver

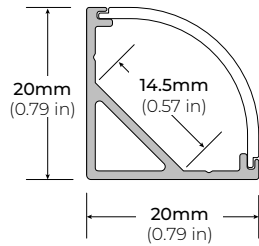

ALP-80

LENGTHS 49.25" | 98.5"
LENS Frosted
FINISH Silver

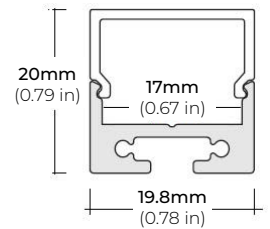

ALP-90

LENGTHS 48" | 96"
LENS Frosted
FINISH Black | Silver

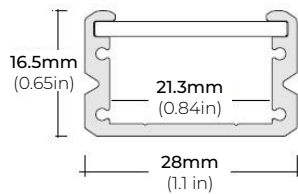

ALP-102

LENGTHS 49" | 98"
LENS Frosted, Black, Asymmetric, Double Asymmetric
FINISH Silver

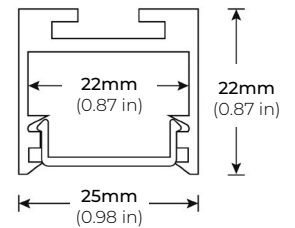

* For more compatible profiles, visit corelightingusa.com

RECESSED PROFILES

ALP-70R

LENGTHS 48" | 98"
LENS Frosted
FINISH Black | Silver

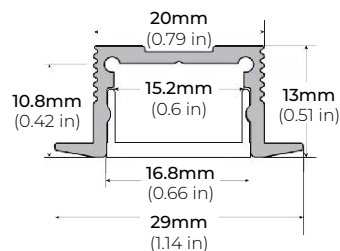

ALP-210RN

LENGTHS 49" | 98"
LENS Frosted
FINISH Silver

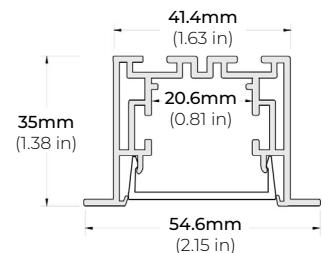

* For more compatible profiles, visit corelightingusa.com

LSMW-40HF

4.0W OUTDOOR RATED FLEXIBLE LED STRIP

COMPATIBLE TRANSFORMERS

PSDL SERIES TRIAC DIMMABLE

PSDL-30W-24V	CLASS 2	6.5" X 3.63" X 1.03"
PSDL-60W-24V	CLASS 2	7.4" X 3.63" X 1.03"
PSDL-96W-24V	CLASS 2	8.67" X 3.67 X 1.62"
PSDL-150W-24V		8.67" X 3.67" X 1.62"
PSDL-192W-24V	CLASS 2	10.25" X 4.06" X 1.82"
PSDL-200W-24V		10.25" X 4.06" X 1.82"
PSDL-288W-24V	CLASS 2	10.25" X 4.06" X 1.82"
PSDL-300W-24V		10.25" X 4.06" X 1.82"

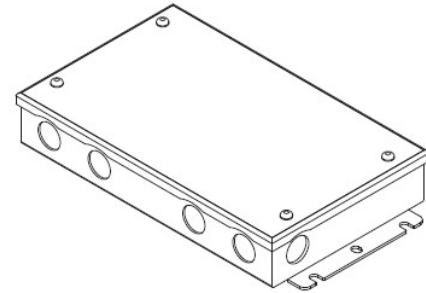

PSDH SERIES HIGH PERFORMANCE MAGNETIC LOW VOLTAGE (MLV)

PSDH-48W-24V	CLASS 2	11.25" X 3.37" X 3.25"
PSDH-96W-24V	CLASS 2	11.25" X 3.37" X 3.25"
PSDH-288W-24V	CLASS 2	14.25" X 8.43" X 4.43"

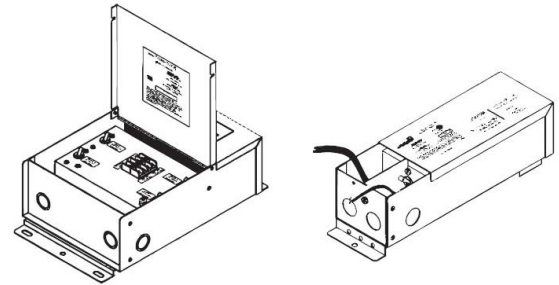

PSRX SERIES 4-IN-1 DIMMING DRIVER

PSRX-30W-24V	CLASS 2	6.5" X 3.72" X 1.57"
PSRX-60W-24V	CLASS 2	7.4" X 3.72" X 1.57"
PSRX-96W-24V	CLASS 2	8.66" X 3.72" X 1.57"
PSRX-150W-24V		10.24" X 4.13" X 1.77"
PSRX-192W-24V	CLASS 2	11" X 4" X 1.82"
PSRX-200W-24V		10.24" X 4.13" X 1.77"
PSRX-288W-24V	CLASS 2	11.85" X 4.25" X 1.82"
PSRX-300W-24V		10.94" X 4.33" X 1.77"

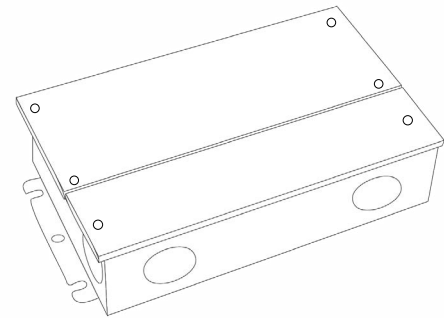

PSVT SERIES 0-10V DIMMING DRIVER

PSVT-60W-24V	CLASS 2	7.4" X 3.72" X 1.57"
PSVT-96W-24V	CLASS 2	8.66" X 3.72" X 1.57"
PSVT-200W-24V		10.24" X 4.13" X 1.77"
PSVT-288W-24V	CLASS 2	11.85" X 4.25" X 1.81"
PSVT-300W-24V		10.94" X 4.33" X 1.77"

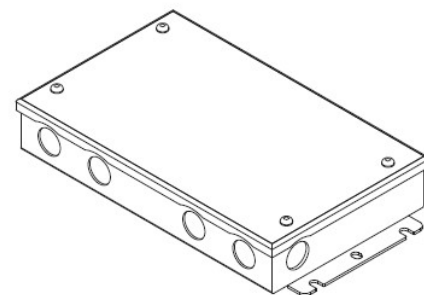

LSMW-40HF

4.0W OUTDOOR RATED FLEXIBLE LED STRIP

COMPATIBLE TRANSFORMERS

PSDE SERIES
0-10V DIMMING W/ JUNCTION BOX

PSDE-60W-24V-010-JB CLASS 2 12.1" X 2.36" X 1.4"
PSDE-96W-24V-010-JB CLASS 2 12.1" X 2.36" X 1.4"

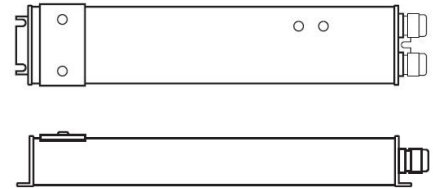

LUTRON 1%
3-WIRE DIMMING

L3DA4U1UKL-CV240 CLASS 2 4.89" X 4" X 2.62"

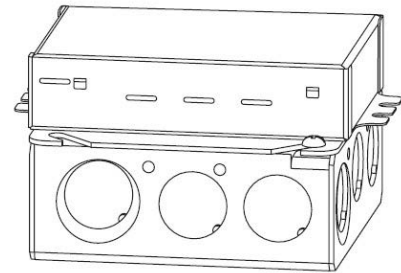

LUTRON 1%

PSDE-96W-24V-ECO CLASS 2 10.5" X 3.0" X 2.0"

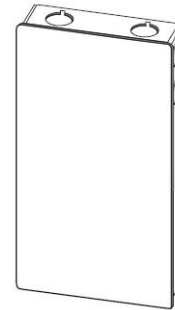

COMPATIBLE NON-DIMMING DRIVERS

PSHK SERIES
NON-DIMMING CONSTANT VOLTAGE WITH JUNCTION BOX

PSHK-30W-24V CLASS 2 6.5" X 3.6" X 1.02"
PSHK-60W-24V CLASS 2 7.4" X 3.62" X 1.02"
PSHK-96W-24V CLASS 2 8.66" X 3.66" X 1.61"
PSHK-150W-24V 10.24" X 4.06" X 1.81"
PSHK-200W-24V 10.24" X 4.06" X 1.81"
PSHK-288W-24V CLASS 2 11.85" X 4.25" X 1.82"
PSHK-300W-24V 10.24" X 4.25" X 1.81"

