

# LSRN-20N

## 2.2W NAUTICAL OUTDOOR FLEXIBLE LED STRIP

Project \_\_\_\_\_  
Location \_\_\_\_\_  
Quote/ Ref # \_\_\_\_\_

**LSRN SERIES** is a high performance, water-resistant LED strip designed for all-weather and harsh environments. It is manufactured with a patented epoxy PVC material that makes the LED strip resistant to saltwater, chlorine, rain, and humidity. The LSRN Series is the perfect solution for lighting areas where exposure to extreme elements cannot be avoided.

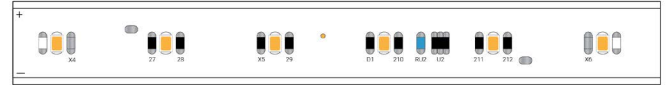

### SPECIFICATIONS

INPUT VOLTAGE	24V DC
POWER CONSUMPTION	2.2W/Ft.
NO. OF LEDS	19 LEDs per Ft.
LUMEN OUTPUT	275 Lm/Ft. (30K)
CRI	90+
COLOR TEMPERATURE	27K / 30K / 40K / RGB
DIMMING	Compatible with CL Dimmers
MAXIMUM RUN LENGTH	32.8 Ft.
FIELD CUTTABLE	NO
BINNING	1.5 Step Macadam Elipse
OPERATING TEMPERATURE	-40°F (-40°C) ~ 122°F (60°C)
BEAM ANGLE	120°
IP RATING	IP65 wet location (outdoor)
CERTIFICATIONS	ETL / UL listed
LUMEN MAINTENANCE	50,000 Hrs

### FEATURES

- 2.2W per Ft.
- 19 LEDs per Ft.
- Water resistant
- Suitable for WET / OUTDOOR applications
- Multiple CCT options available
- Superior COLOR RENDERING INDEX (CRI)
- UL Listed



MODEL	COLOR TEMP	LENGTH	VOLTAGE
LSRN20N	<b>27K</b> 2700K	<b>16</b> 16.4 Ft.	<b>24</b> 24V DC
	<b>30K</b> 3000K	<b>32</b> 32 Ft.	
	<b>40K</b> 4000K	<b>1'PF</b> Per Ft.	
	<b>RGB</b> RGB		
*1 = Custom length per FT. (Cuttable every 6.5")			

# LSRN-20N

## 2.2W NAUTICAL OUTDOOR FLEXIBLE LED STRIP

### DIMENSIONS

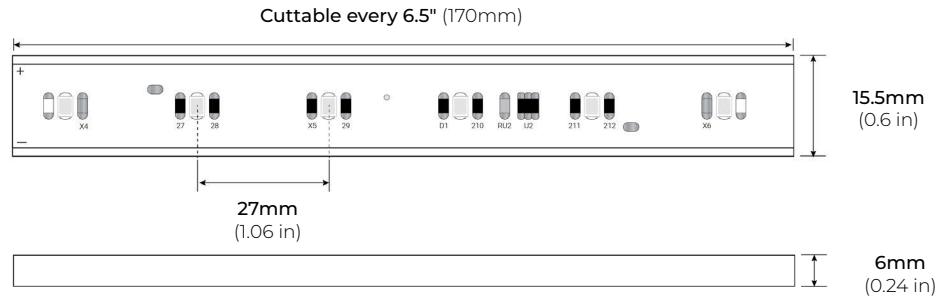

### COMPATIBLE ACCESSORIES

**LSRN-AC2**  
2" ALUMINUM CHANNEL

**LSRN-AC39**  
39" ALUMINUM CHANNEL

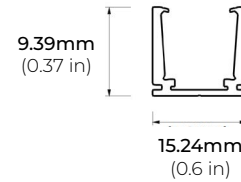

### HARDWIRE CONNECTOR KIT

**LSRN-HW36**  
36" CONNECTOR

**LSRN-HW120**  
120" CONNECTOR

**LSRN-HW200**  
200" CONNECTOR

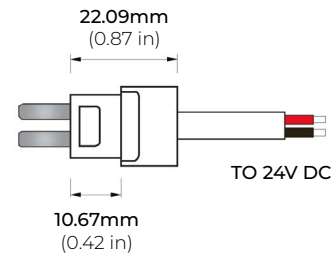

\*Includes 1 Connector, 1 PC cover, 1 Anti-skidding clip, and 1 Heat-shrink tube.

### INTERLINK CABLE KIT

**LSRN-EX2**  
2" LINK CABLE

**LSRN-EX6**  
6" LINK CABLE

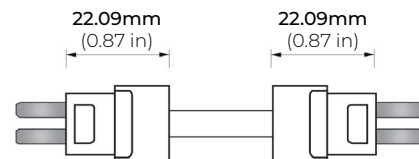

\*Includes 1 Interlink cable, 2 PC covers, 2 Anti-skidding clips, and 2 Heat-shrink tubes.

### SEAMLESS COUPLING KIT

**LSRN-MC**  
MINI COUPLING

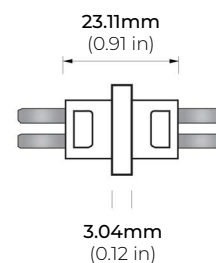

\*Includes 1 Coupling, 2 PC covers, 2 Anti-skidding clips, and 1 Heat-shrink tube.

# LSRN-20N

## 2.2W NAUTICAL OUTDOOR FLEXIBLE LED STRIP

### COMPATIBLE TRANSFORMERS

#### PSDL SERIES TRIAC DIMMABLE

PSDL-30W-24V	CLASS 2	6.5" X 3.63" X 1.03"
PSDL-60W-24V	CLASS 2	7.4" X 3.63" X 1.03"
PSDL-96W-24V	CLASS 2	8.67" X 3.67" X 1.62"
PSDL-150W-24V		8.67" X 3.67" X 1.62"
PSDL-192W-24V	CLASS 2	10.25" X 4.06" X 1.82"
PSDL-200W-24V		10.25" X 4.06" X 1.82"
PSDL-288W-24V	CLASS 2	10.25" X 4.06" X 1.82"
PSDL-300W-24V		10.25" X 4.06" X 1.82"

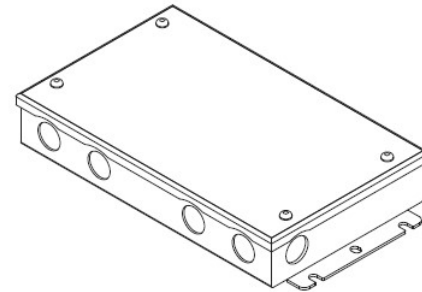

#### PSDH SERIES HIGH PERFORMANCE MAGNETIC LOW VOLTAGE (MLV)

PSDH-48W-24V	CLASS 2	11.25" X 3.38" X 3.38"
PSDH-96W-24V	CLASS 2	11.25" X 3.38" X 3.37"
PSDH-288W-24V	CLASS 2	14.25" X 8.43" X 4.43"

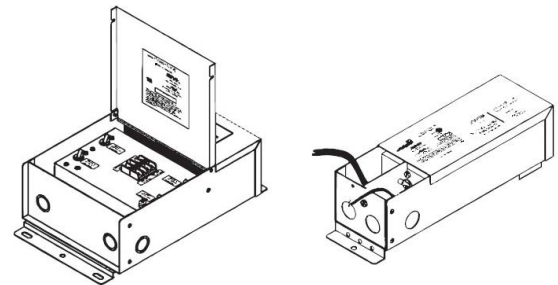

#### PSRX SERIES 4-IN-1 DIMMING DRIVER W/ JUNCTION BOX

PSRX-30W-24V-UNV	CLASS 2	6.5" X 3.7" X 1.57"
PSRX-60W-24V-UNV	CLASS 2	7.4" X 3.72" X 1.57"
PSRX-96W-24V-UNV	CLASS 2	8.66" X 3.72" X 1.57"
PSRX-150W-24V-UNV		10.24" X 4.13" X 1.77"
PSRX-200W-24V-UNV		10.24" X 4.13" X 1.77"
PSRX-300W-24V-UNV		10.94" X 4.33" X 1.77"

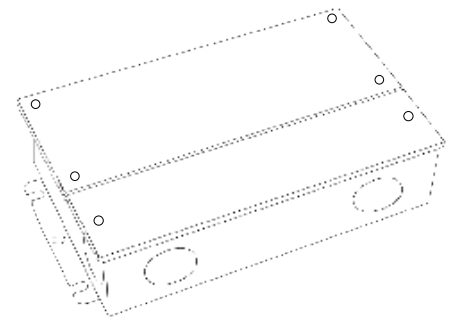

#### PSVT SERIES 0-10V DIMMING DRIVER

PSVT-60W-24V	CLASS 2	7.4" X 3.72" X 1.57"
PSVT-96W-24V	CLASS 2	8.66" X 3.72" X 1.57"
PSVT-200W-24V		10.24" X 4.13" X 1.77"
PSVT-288W-24V	CLASS 2	11.85" X 4.25" X 1.81"
PSVT-300W-24V		10.94" X 4.33" X 1.77"

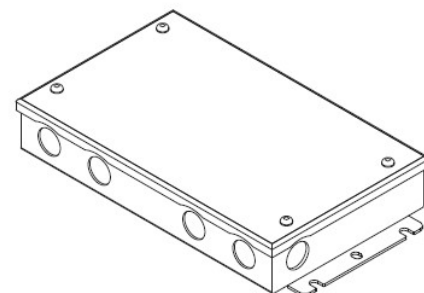

# LSRN-20N

## 2.2W NAUTICAL OUTDOOR FLEXIBLE LED STRIP

### COMPATIBLE TRANSFORMERS

#### PSDE SERIES

0-10V DIMMING W/ JUNCTION BOX

PSDE-60W-24V-010-JB	CLASS 2	12.1" X 2.36" X 1.4"
PSDE-96W-24V-010-JB	CLASS 2	12.1" X 2.36" X 1.4"

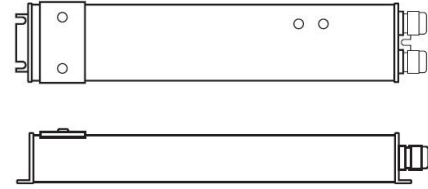

#### LUTRON 1% 3-WIRE DIMMING

L3DA4JTUKL-CV240	CLASS 2	4.89" X 4" X 2.62"
------------------	---------	--------------------

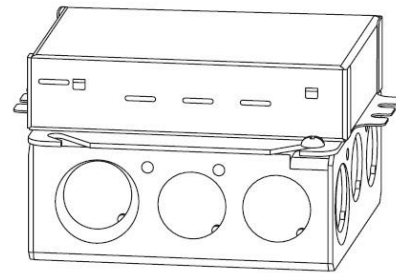

#### LUTRON 1% 3-WIRE DIMMING

PSDE-96W-24V-ECO	CLASS 2	10.5" X 3.0" X 2.0"
------------------	---------	---------------------

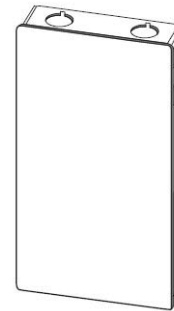

#### PSHK SERIES

NON-DIMMING CONSTANT VOLTAGE WITH JUNCTION BOX

PSHK-30W-24V	CLASS 2	6.5" X 3.6" X 1.02"
PSHK-60W-24V	CLASS 2	7.4" X 3.62" X 1.02"
PSHK-96W-24V	CLASS 2	8.66" X 3.66" X 1.61"
PSHK-150W-24V		10.24" X 4.06" X 1.81"
PSHK-200W-24V		10.24" X 4.06" X 1.81"
PSHK-288W-24V	CLASS 2	11.85" X 4.25" X 1.82"
PSHK-300W-24V		10.24" X 4.25" X 1.81"

