

LSE-300

3.0W ECO SERIES INDOOR FLEXIBLE LED STRIP

Project _____
Location _____
Quote/ Ref # _____

LSE300 is a dimmable flexible LED strip capable of delivering 234 lumens of light output per Ft. Suitable for use in cove lighting, under cabinets, architectural and aesthetic enhancements. It features superior CRI and different color temperature options.

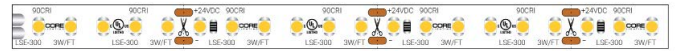

SPECIFICATIONS

INPUT VOLTAGE	12V 24V DC
POWER CONSUMPTION	3W per Ft.
LEDS/ FT.	36 LEDES per Ft.
LUMEN OUTPUT	234 Lumens per Ft.
CRI	90+
COLOR TEMPERATURE	27K/ 30K/ 40K
DIMMING	MLV, ELV, 0-10 and TRIAC
MAXIMUM RUN LENGTH	16 Ft. (12V) 20Ft. (24V)
CUTTABLE	Every 1 In (12V) Every 2 In. (24V)
BINNING	1.5-Step MacAdam Elipse
OPERATING TEMPERATURE	-40°F(-40°C)~140°F(60°C)
BEAM ANGLE	120°
IP RATING	IP54 dry location (Indoor)
CERTIFICATIONS	UL Listed
LUMEN MAINTENANCE	35,000 Hrs.

FEATURES

- 3W per Ft.
- 234 Lumens
- 90+ CRI
- Field Cuttable
- Suitable for accent or ambient lighting
- Multiple CCT options available
- UL Listed



MODEL	COLOR TEMP	LED LENGTH	VOLTAGE	PROFILE
LSE300	27K 2700K	16 16 Ft.	12 12V	See Page 3 - 4 for compatible profiles.
	30K 3000K	100 100 Ft.	24 24V	
	40K 4000K			

* Custom color finishes require powder coating. Allow 7 days leads time.

LSE-300

3.0W ECO SERIES INDOOR FLEXIBLE LED STRIP

DIMENSIONS

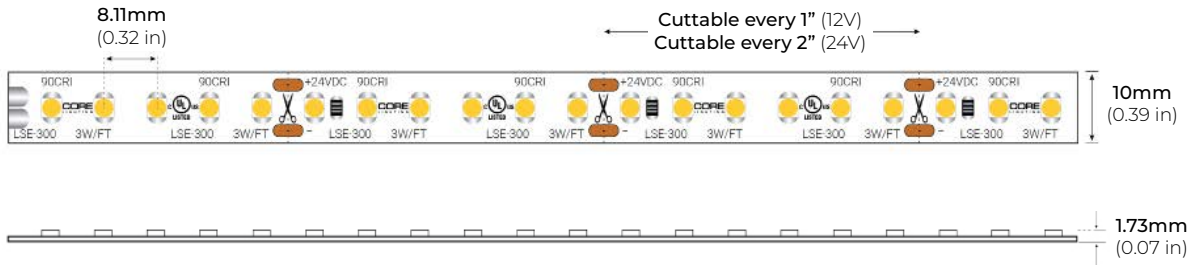

COMPATIBLE CONNECTORS

HP PRO CONNECTORS

QUICK CONNECT SNAP-ON

- LSA-HW8-HP 8" HARDWIRE CONNECTOR
- LSA-HW24-HP 24" HARDWIRE CONNECTOR
- LSA-HW60-HP 60" HARDWIRE CONNECTOR
- LSA-HW120-HP 120" HARDWIRE CONNECTOR

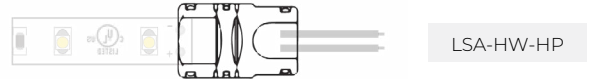

- LSA-EX3-HP 3" LINK
- LSA-EX8-HP 8" LINK
- LSA-EX24-HP 24" LINK

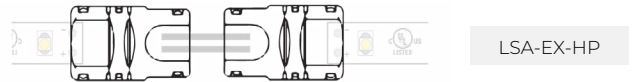

- LSA-MC-HP MINI COUPLING



- LSA-DC24-HP 24" DC CONNECTOR

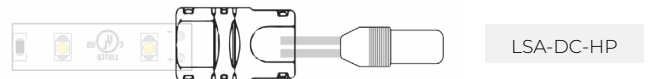

LSE-300

3.0W ECO SERIES INDOOR FLEXIBLE LED STRIP

COMPATIBLE ALUMINUM PROFILES

SURFACE PROFILES

ALU-SF

LENGTHS 39" | 78" | 84" | 98"
LENS Clear, Frosted
FINISH Black | Silver

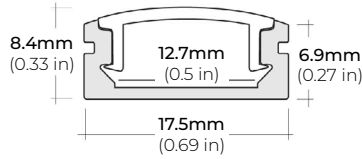

ALU-DS100

LENGTHS 39" | 78" | 84"
LENS Clear, Frosted
FINISH Silver

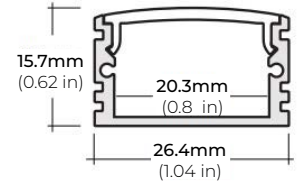

ALP-20

LENGTHS 49" | 84" | 98"
LENS Frosted
FINISH White | Black | Silver

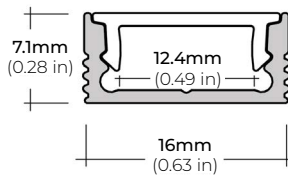

ALP-35

LENGTHS 49" | 98"
LENS Frosted
FINISH White | Black | Silver

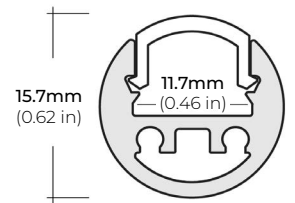

ALP-50C (CORNER)

LENGTHS 48" | 84" | 98"
LENS Frosted
FINISH White | Black | Silver

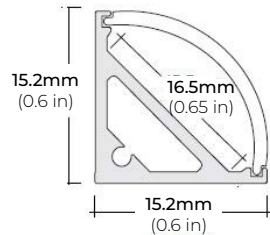

ALP-70

LENGTHS 49" | 84" | 98"
LENS Frosted
FINISH Black | Silver

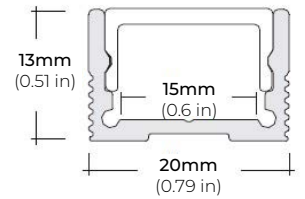

ALP-80

LENGTHS 49" | 98"
LENS Frosted
FINISH Silver

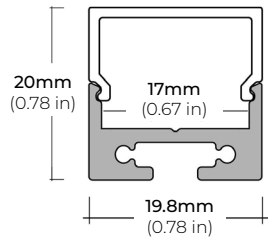

ALP-100C (CORNER)

LENGTHS 48" | 98"
LENS Frosted
FINISH Silver

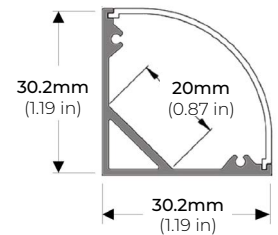

ALP-100K-98 (CORNER)

LENGTHS 48" | 98"
LENS Frosted
FINISH Silver

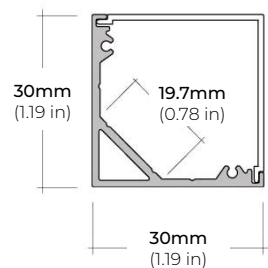

ALP-102

LENGTHS 49" | 98"
LENS Frosted, Black, Asymmetric, Double Asymmetric
FINISH Black | Silver | White

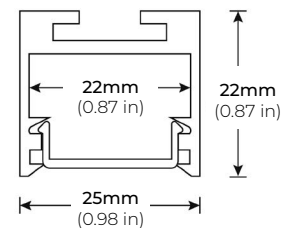

* For more compatible profiles, visit corelightingusa.com

LSE-300

3.0W ECO SERIES INDOOR FLEXIBLE LED STRIP

COMPATIBLE ALUMINUM PROFILES

RECESSED PROFILES

ALP-70R

LENGTHS 48" | 96"
LENS Frosted
FINISH Black | Silver

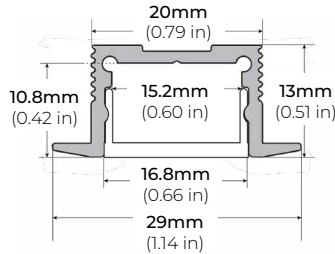

ALP-102R

LENGTHS 49" | 98"
LENS Frosted, Black, Asymmetric, Double Asymmetric
FINISH Silver

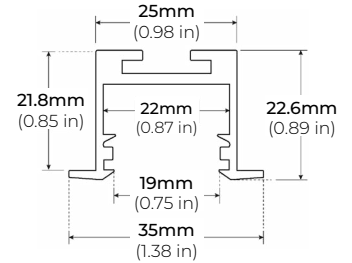

* For more compatible profiles, visit corelightingusa.com

TRIMLESS PROFILES

ALP-1300TL

LENGTHS 48" | 96"
LENS Clear, Frosted
FINISH White

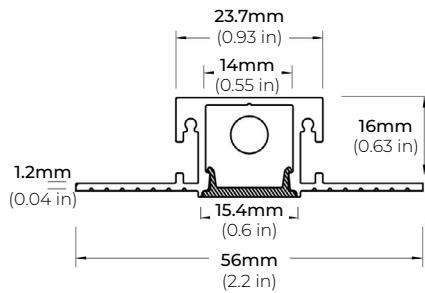

ALP-2300TL

LENGTHS 48" | 96"
LENS Frosted
FINISH White

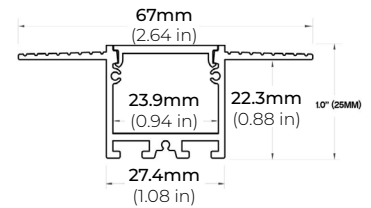

ALP-2400TL

LENGTHS 48" | 96"
LENS Clear, Frosted
FINISH White

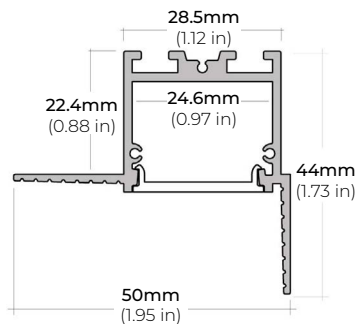

ALP-2700TL

LENGTHS 48" | 96"
LENS Frosted
FINISH White

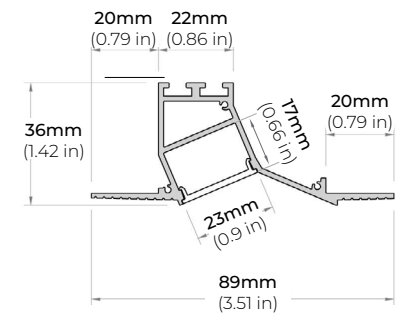

* For more compatible profiles, visit corelightingusa.com

LSE-300

3.0W ECO SERIES INDOOR FLEXIBLE LED STRIP

COMPATIBLE TRANSFORMERS

PSDL SERIES TRIAC DIMMABLE

PSDL-30W-12V	CLASS 2	6.5" X 3.63" X 1.58"
PSDL-60W-12V	CLASS 2	7.4" X 3.63" X 1.58"
PSDL-100W-12V	CLASS 2	8.67" X 3.67 X 1.62"
PSDL-150W-12V		10.25" X 4.06" X 1.82"
PSDL-200W-12V		10.25" X 4.06" X 1.82"
PSDL-300W-12V		10.25" X 4.06" X 1.82"

PSDL-30W-24V	CLASS 2	6.5" X 3.63" X 1.58"
PSDL-60W-24V	CLASS 2	7.4" X 3.63" X 1.58"
PSDL-96W-24V	CLASS 2	8.67" X 3.67 X 1.62"
PSDL-150W-24V		10.25" X 4.06" X 1.82"
PSDL-192W-24V	CLASS 2	11" X 4" X 1.82"
PSDL-200W-24V		10.25" X 4.06" X 1.82"
PSDL-288W-24V	CLASS 2	11.85" X 4.25" X 1.82"
PSDL-300W-24V		10.25" X 4.06" X 1.82"

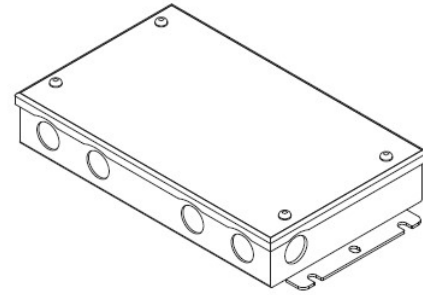

PSDH SERIES HIGH PERFORMANCE MAGNETIC LOW VOLTAGE (MLV)

PSDH-48W-24V	CLASS 2	11.25" X 3.38" X 3.38"
PSDH-96W-24V	CLASS 2	11.25" X 3.38" X 3.37"
PSDH-288W-24V	CLASS 2	14.25" X 8.43" X 4.43"

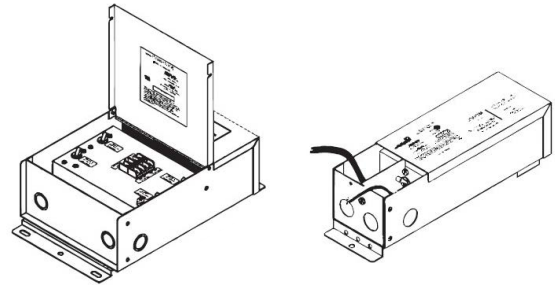

PSRX SERIES 4-IN-1 DIMMING DRIVER W/ JUNCTION BOX

PSRX-30W-12V-UNV	CLASS 2	6.5" X 3.72" X 1.57"
PSRX-60W-12V-UNV	CLASS 2	7.4" X 3.72" X 1.57"
PSRX-150W-12V-UNV		10.24" X 4.13" X 1.77"
PSRX-30W-24V-UNV	CLASS 2	6.5" X 3.7" X 1.57"
PSRX-60W-24V-UNV	CLASS 2	7.4" X 3.72" X 1.57"
PSRX-96W-24V-UNV	CLASS 2	8.66" X 3.72" X 1.57"
PSRX-150W-24V-UNV		10.24" X 4.13" X 1.77"
PSRX-200W-24V-UNV		10.24" X 4.13" X 1.77"
PSRX-300W-24V-UNV		10.94" X 4.33" X 1.77"

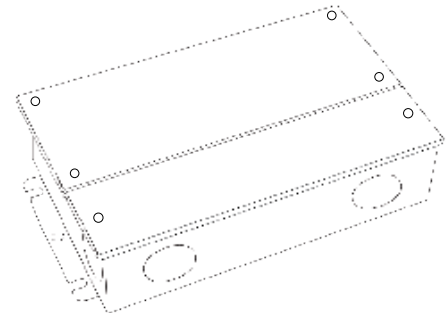

LSE-300

3.0W ECO SERIES INDOOR FLEXIBLE LED STRIP

COMPATIBLE TRANSFORMERS

PSVT SERIES

0-10V DIMMING WITH JUNCTION BOX

PSVT-60W-24V-UNV-010	CLASS 2	7.4" X 3.72" X 1.57"
PSVT-96W-24V-UNV-010	CLASS 2	8.66" X 3.72" X 1.57"
PSVT-200W-24V-UNV-010		10.24" X 4.13" X 1.77"
PSVT-288W-24V-UNV-010	CLASS 2	11.85" X 4.25" X 1.81"
PSVT-300W-24V-UNV-010		10.94" X 4.33" X 1.77"

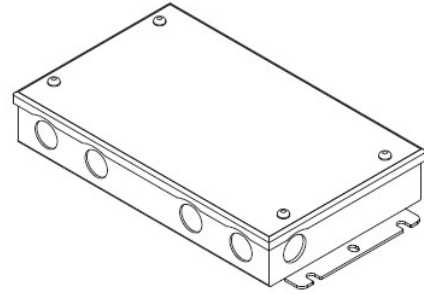

PSDE SERIES

0-10V DIMMING W/ JUNCTION BOX

PSDE-60W-24V-010-JB	CLASS 2	12.1" X 2.36" X 1.4"
PSDE-96W-24V-010-JB	CLASS 2	12.1" X 2.36" X 1.4"

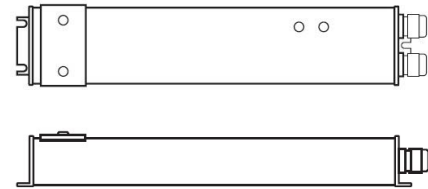

LUTRON 1%

3-WIRE DIMMING

L3DA4U1UKL-CV240	CLASS 2	4.89" X 4" X 2.62"
------------------	---------	--------------------

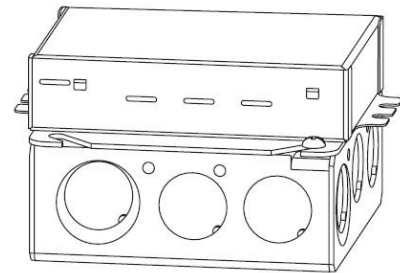

LUTRON 1%

3-WIRE DIMMING

PSDE-96W-24V-ECO	CLASS 2	10.5" X 3.0" X 2.0"
------------------	---------	---------------------

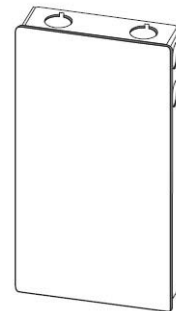

LSE-300

3.0W ECO SERIES INDOOR FLEXIBLE LED STRIP

COMPATIBLE NON-DIMMING DRIVERS

PSHK SERIES

NON-DIMMING CONSTANT VOLTAGE WITH JUNCTION BOX

PSHK-30W-24V	CLASS 2	6.5" X 3.6" X 1.02"
PSHK-60W-24V	CLASS 2	7.4" X 3.62" X 1.02"
PSHK-96W-24V	CLASS 2	8.66" X 3.66" X 1.61"
PSHK-150W-24V		10.24" X 4.06" X 1.81"
PSHK-200W-24V		10.24" X 4.06" X 1.81"
PSHK-288W-24V	CLASS 2	11.85" X 4.25" X 1.82"
PSHK-300W-24V		10.94" X 4.25" X 1.81"

