

# LFO-90DB

## 7.6W DUAL BEND OPTIC LED STRIP

Project \_\_\_\_\_

Location \_\_\_\_\_

Quote/ Ref # \_\_\_\_\_

**LFO-90DB** is a 24V flexible indoor and outdoor optical LED strip. With its unique design, the LFO-90DB is able to bend horizontally or vertically, making it easy to create customized lighting arrangements. Its linear design and multiple angle options are ideal for creating a dramatic accent wall or simply adding a touch of warmth to your living space. Available in multiple color temperatures, this LED strip is the perfect choice for your decorative lighting needs.



### SPECIFICATIONS

<b>POWER CONSUMPTION</b>	7.6W per Ft.
<b>LUMEN OUTPUT</b>	686 Lm/Ft.
<b>CRI</b>	90+
<b>COLOR TEMPERATURE</b>	27K/ 30K/ 40K
<b>DIMMING/ CONTROL</b>	MLV, ELV, 0-10 and TRIAC
<b>MAXIMUM RUN LENGTH</b>	16.4 Ft.
<b>CUTTABLE</b>	Every 9.84 in. (250mm)
<b>OPERATING VOLTAGE</b>	24V DC
<b>OPERATING TEMPERATURE</b>	-4°F (-20°C) to 113°F (45°C)
<b>BEAM ANGLE</b>	10°/ 15°/ 20°/ 25°/ 30°/ 40°/ 50°/ 25°x50°/ 45°x 30°
<b>IP RATING</b>	IP67
<b>CERTIFICATIONS</b>	CE, RoHS, UL Listed
<b>LUMEN MAINTENANCE</b>	50,000 Hrs.

### FEATURES

- 7.6W/ Ft.
- 24V DC
- 90+ CRI
- Continuous Run up to 16.4 Ft.
- Flexible, Silicone encapsulated
- Dual Bend Capabilities
- CE, RoHS, UL Listed



MODEL	COLOR TEMP	OPTIC		LENGTH	VOLTAGE	POWER FEED	FEED LENGTH
LFO-90DB	<b>27K</b> 2700K	<b>10</b> 10°	<b>40</b> 40°	1XX per Ft.	24 24V DC	<b>BF</b> Bottom Feed	<b>HW3</b> 3 Ft. Power Feed
	<b>30K</b> 3000K	<b>15</b> 15°	<b>50</b> 50°			<b>SFL</b> Side Feed Left	<b>HW10</b> 10 Ft. Power Feed
	<b>40K</b> 4000K	<b>20</b> 20°	<b>2550</b> 25° x 50°			<b>SFR</b> Side Feed Right	<b>HW15</b> 15 Ft. Power Feed
		<b>25</b> 25°	<b>4530</b> 45° x 30°			<b>EF</b> End Feed	
		<b>30</b> 30°					

\*1 = Custom length per FT. (cuttable every 9.84")

# LFO-90DB

## 7.6W DUAL BEND OPTIC LED STRIP

### DIMENSIONS

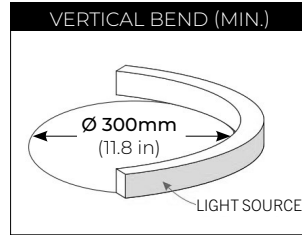
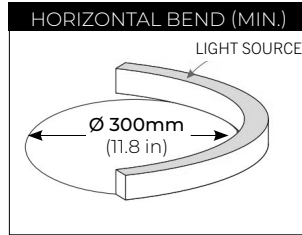
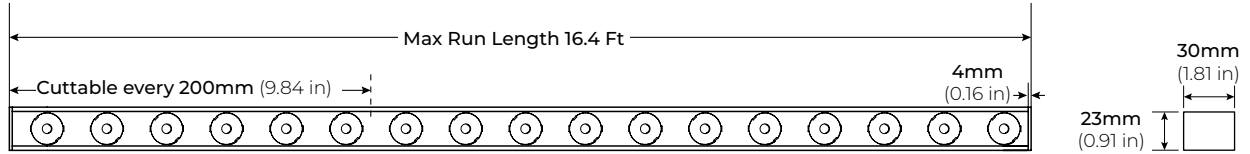

### COMPATIBLE ACCESSORIES

**LFO90-MB**  
ALUMINUM MOUNTING CLIP  
50 X 34 X 26mm (L x W x H)

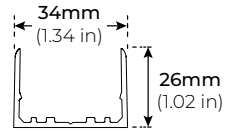
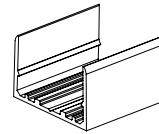

**LFO90-AC39**  
ALUMINUM PROFILE  
1000 X 34 X 26mm (L x W x H)

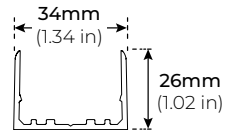
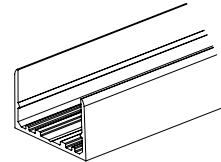

**LFO90-BKT-ADJ**  
ADJUSTABLE BRACKET

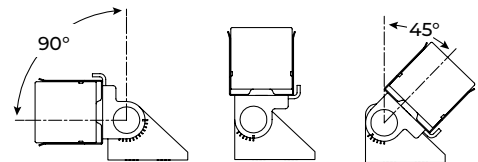

# LFO-90DB

## 7.6W DUAL BEND OPTIC LED STRIP

### OPTICS

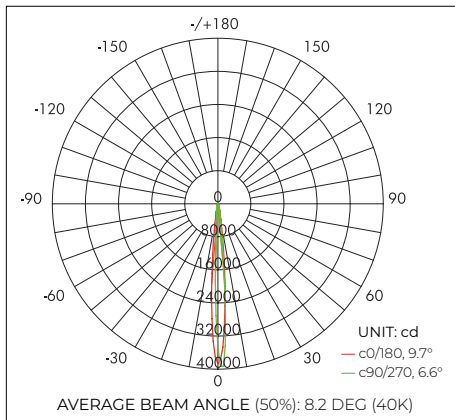

10°

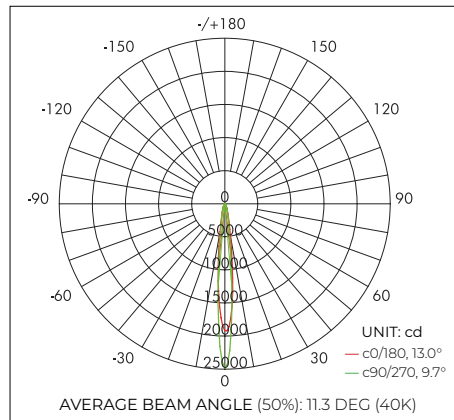

15°

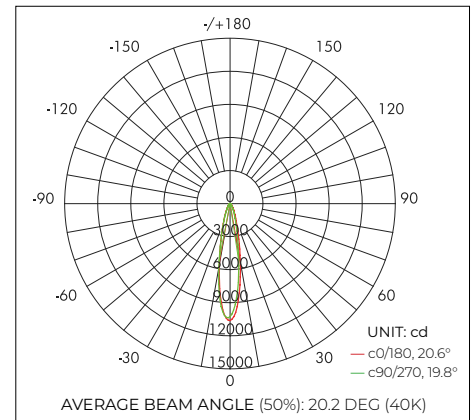

20°

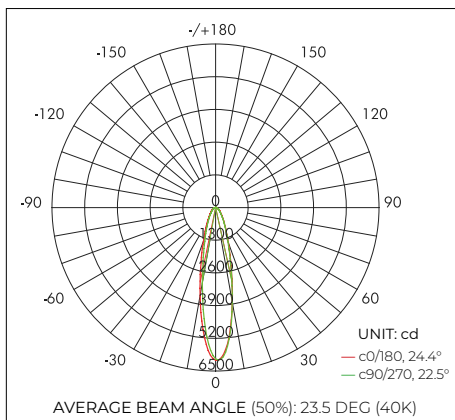

25°

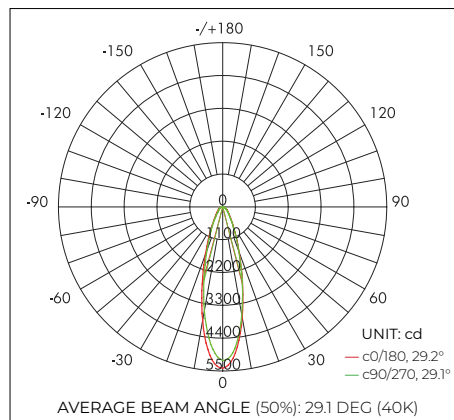

30°

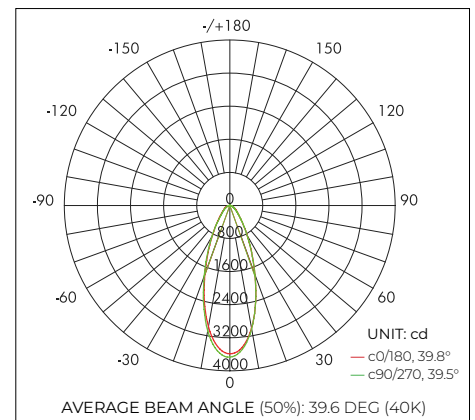

40°

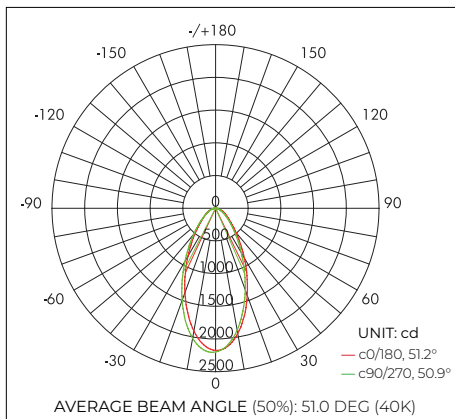

50°

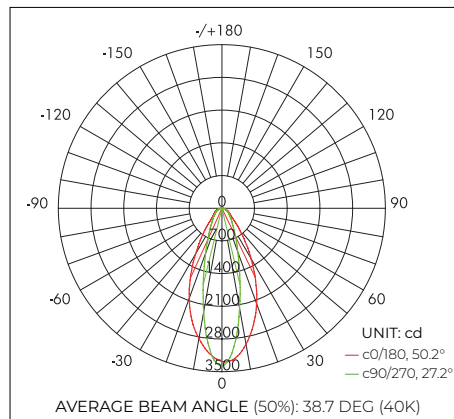

25° X 50°

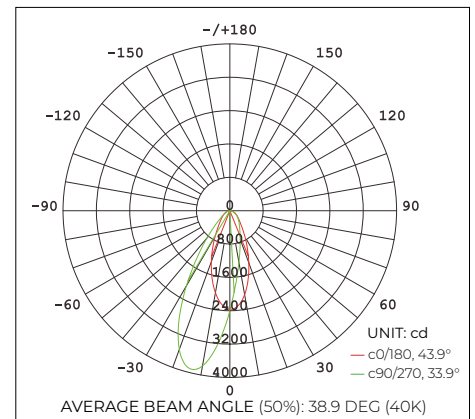

45° X 30°

# LFO-90DB

## 7.6W DUAL BEND OPTIC LED STRIP

### POWER FEED

---

**BF**  
BOTTOM FEED



**SFL**  
SIDE LEFT FEED

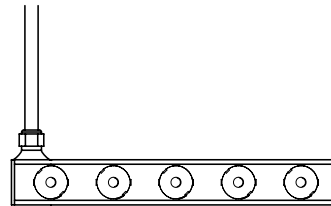

**SFR**  
SIDE RIGHT FEED

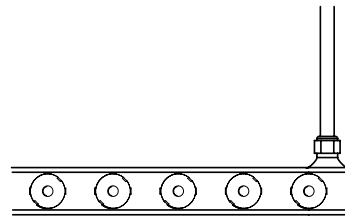

**EF**  
END FEED

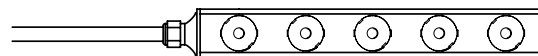

# LFO-90DB

## 7.6W DUAL BEND OPTIC LED STRIP

### LIGHT DISTRIBUTION

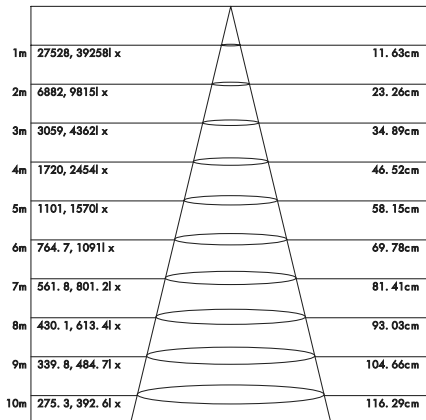

**10°**  
(4000K)

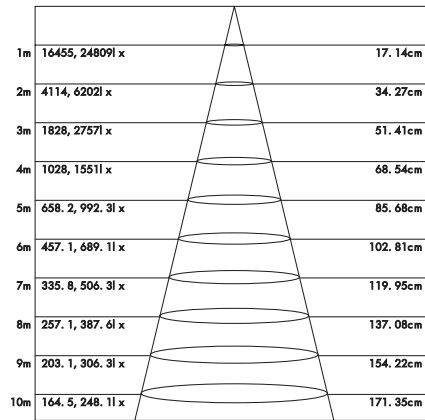

**15°**  
(4000K)

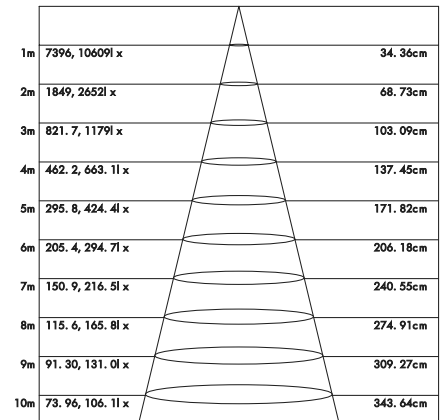

**20°**  
(4000K)

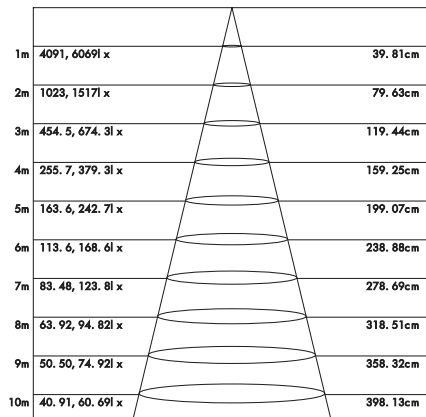

**25°**  
(4000K)

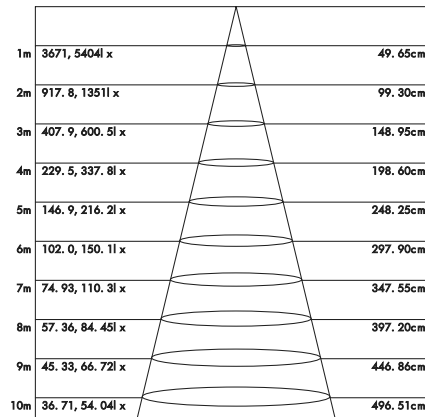

**30°**  
(4000K)

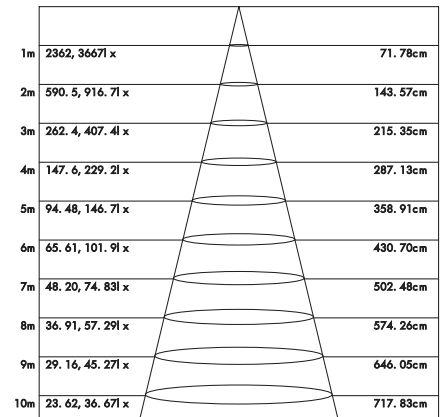

**40°**  
(4000K)

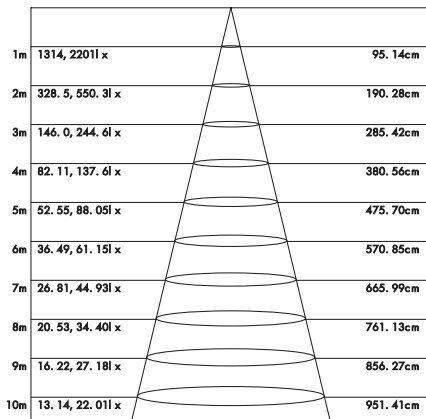

**50°**  
(4000K)

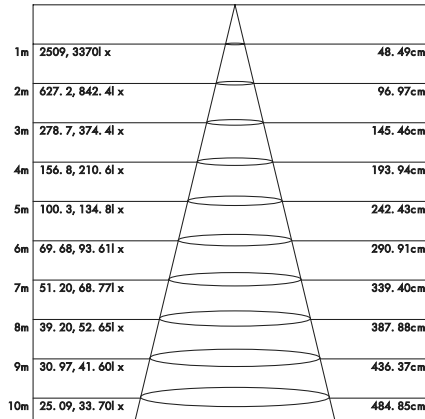

**25° X 50°**  
(4000K)

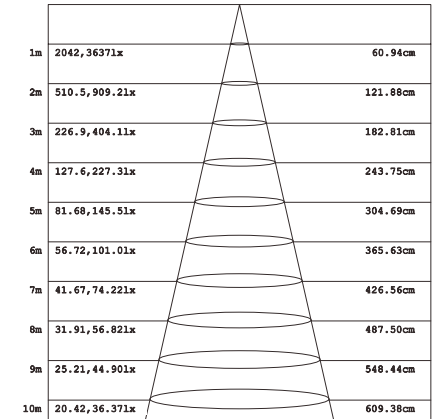

**45° X 30°**  
(4000K)

# LFO-90DB

## 7.6W DUAL BEND OPTIC LED STRIP

### COMPATIBLE TRANSFORMERS

#### PSDL SERIES TRIAC DIMMABLE

PSDL-30W-24V	CLASS 2	6.5" X 3.63" X 1.03"
PSDL-60W-24V	CLASS 2	7.4" X 3.63" X 1.03"
PSDL-96W-24V	CLASS 2	8.67" X 3.67 X 1.62"
PSDL-150W-24V		8.67" X 3.67" X 1.62"
PSDL-192W-24V	CLASS 2	10.25" X 4.06" X 1.82"
PSDL-200W-24V		10.25" X 4.06" X 1.82"
PSDL-288W-24V	CLASS 2	10.25" X 4.06" X 1.82"
PSDL-300W-24V		10.25" X 4.06" X 1.82"

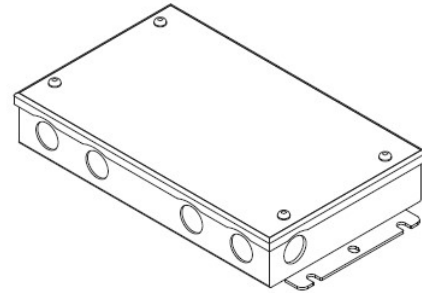

#### PSDH SERIES HIGH PERFORMANCE MAGNETIC LOW VOLTAGE (MLV)

PSDH-48W-24V	CLASS 2	11.25" X 3.37" X 3.25"
PSDH-96W-24V	CLASS 2	11.25" X 3.37" X 3.25"
PSDH-288W-24V	CLASS 2	14.25" X 8.43" X 4.43"

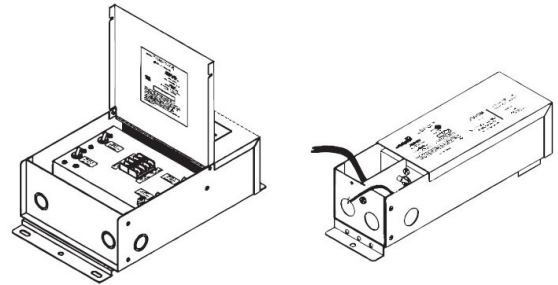

#### PSRX SERIES 4-IN-1 DIMMING DRIVER

PSRX-30W-24V	CLASS 2	6.5" X 3.72" X 1.57"
PSRX-60W-24V	CLASS 2	7.4" X 3.72" X 1.57"
PSRX-96W-24V	CLASS 2	8.66" X 3.72" X 1.57"
PSRX-150W-24V		10.24" X 4.13" X 1.77"
PSRX-192W-24V	CLASS 2	11" X 4" X 1.82"
PSRX-200W-24V		10.24" X 4.13" X 1.77"
PSRX-288W-24V	CLASS 2	11.85" X 4.25" X 1.82"
PSRX-300W-24V		10.94" X 4.33" X 1.77"

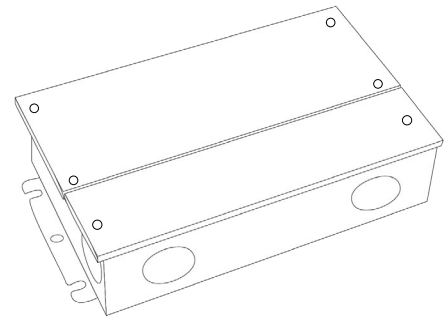

#### PSVT SERIES 0-10V DIMMING DRIVER

PSVT-60W-24V	CLASS 2	7.4" X 3.72" X 1.57"
PSVT-96W-24V	CLASS 2	8.66" X 3.72" X 1.57"
PSVT-200W-24V		10.24" X 4.13" X 1.77"
PSVT-288W-24V	CLASS 2	11.85" X 4.25" X 1.81"
PSVT-300W-24V		10.94" X 4.33" X 1.77"

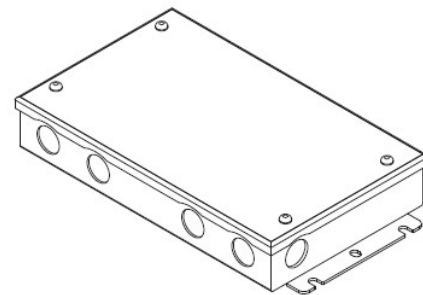

# LFO-90DB

## 7.6W DUAL BEND OPTIC LED STRIP

### COMPATIBLE TRANSFORMERS

#### PSDE SERIES

0-10V DIMMING W/ JUNCTION BOX

PSDE-60W-24V-010-JB	CLASS 2	12.1" X 2.36" X 1.4"
PSDE-96W-24V-010-JB	CLASS 2	12.1" X 2.36" X 1.4"

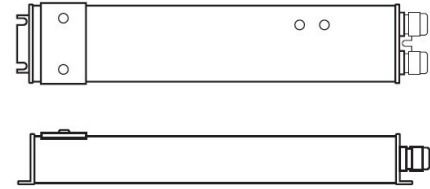

#### LUTRON 1%

3-WIRE DIMMING

L3DA4U1UKL-CV240	CLASS 2	4.89" X 4" X 2.62"
------------------	---------	--------------------

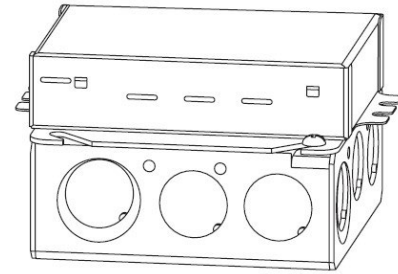

#### LUTRON 1%

3-WIRE DIMMING

PSDE-96W-24V-ECO	CLASS 2	10.5" X 3.0" X 2.0"
------------------	---------	---------------------

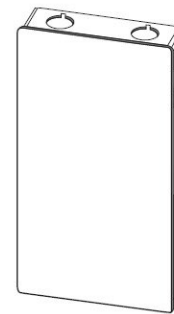

### NON-DIMMING DRIVERS (COMPATABLE WITH ALL SYSTEMS)

#### PSHK SERIES

NON-DIMMING CONSTANT VOLTAGE WITH JUNCTION BOX

PSHK-30W-24V	CLASS 2	6.5" X 3.6" X 1.02"
PSHK-60W-24V	CLASS 2	7.4" X 3.62" X 1.02"
PSHK-96W-24V	CLASS 2	8.66" X 3.66" X 1.61"
PSHK-150W-24V		10.24" X 4.06" X 1.81"
PSHK-200W-24V		10.24" X 4.06" X 1.81"
PSHK-288W-24V	CLASS 2	11.85" X 4.25" X 1.82"
PSHK-300W-24V		10.24" X 4.25" X 1.81"

