

LSP-50

4.4W INDOOR FLEXIBLE LED STRIP

Project _____

Location _____

Quote/ Ref # _____

LSP-50 is a dimmable flexible LED strip capable of delivering 380 Lumens of light output per Ft. This LED strip is rated to last 50,000 hours making it an excellent replacement for halogen lighting. Its innovative low profile design makes it suitable for use in cove lighting, under cabinets architectural and aesthetic enhancements.



SPECIFICATIONS

INPUT VOLTAGE	12V 24V DC
POWER CONSUMPTION	4.4W/Ft.
NO. OF LEDS	18 LEDs per Ft.
LUMEN OUTPUT	380 Lm/Ft.
CRI	95+
COLOR TEMPERATURE	25K / 27K / 30K / 35K / 40K / 50K / 60K
DIMMING	MLV, ELV, 0-10 and TRIAC
MAXIMUM RUN LENGTH	16 Ft. (12V) 24 Ft. (24V)
CUTTABLE	Every 1.97 in (50mm) (12V) Every 3.93 in (99.75mm) (24V)
BINNING	1.5 Step Macadam Elipse
OPERATING TEMPERATURE	-40°F (-40°C) ~ +140°F (+60°C)
BEAM ANGLE	120°
IP RATING	IP45 dry location (Indoor)
CERTIFICATIONS	UL Listed, TITLE 24 JA8
LUMEN MAINTENANCE	50,000 Hrs.

*Approved for closet / storage space installation per NEC 410.16(A)(3) and 410.16(C)(5)



MODEL	COLOR TEMP	LENGTH	VOLTAGE	PROFILE
LSP50	25K 2500K	16 16 Ft.	12 12V	<i>See Page 3 for compatible profiles.</i>
	27K 2700K	100 100 Ft.	24 24V DC	
	30K 3000K	1XX per Ft.		
	35K 3500K			
	40K 4000K			
	50K 5000K			
	60K 6000K			
		*1 = Custom length per FT. (12V Strip cuttable every 1.97") (24V Strip cuttable every 3.93")		* Custom color finishes require powder coating. Allow 7 days leads time.

LSP-50

4.4W INDOOR FLEXIBLE LED STRIP

DIMENSIONS

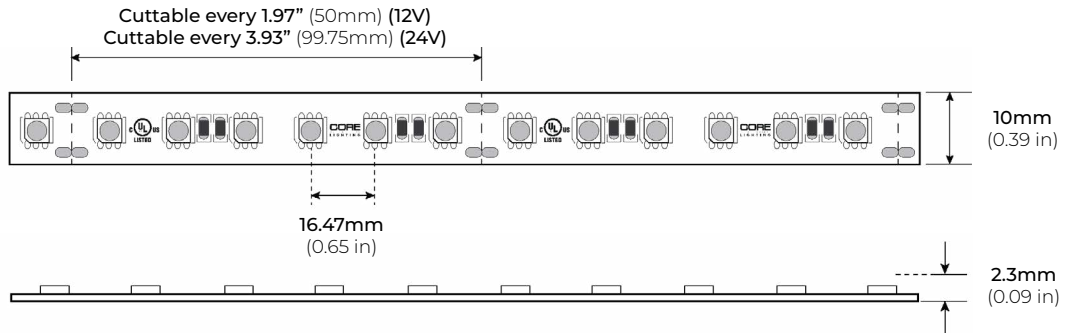

COMPATIBLE CONNECTORS

HP PRO CONNECTORS

QUICK CONNECT SNAP-ON

- LSA-HW8-HP 8" HARDWIRE CONNECTOR
- LSA-HW24-HP 24" HARDWIRE CONNECTOR
- LSA-HW60-HP 60" HARDWIRE CONNECTOR
- LSA-HW120-HP 120" HARDWIRE CONNECTOR

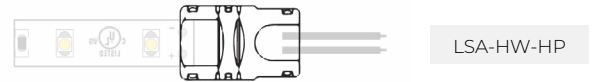

- LSA-EX3-HP 3" LINK
- LSA-EX8-HP 8" LINK
- LSA-EX24-HP 24" LINK

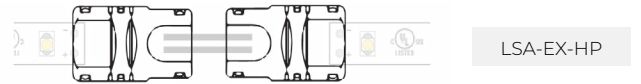

- LSA-MC-HP MINI COUPLING



- LSA-DC24-HP 24" DC CONNECTOR

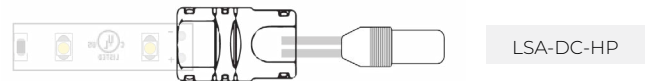

LSA-TB

SOLDERLESS LED STRIP/ WIRE BLOCK CONNECTOR

- LSA-TB-HWC 6A HARDWIRE CONNECTOR
- LSA-TB-MC STRIP TO STRIP COUPLING
- LSA-TB-HWP-10A 10A HARDWIRE CONNECTOR

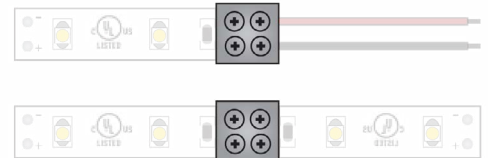

LSP-50

4.4W INDOOR FLEXIBLE LED STRIP

COMPATIBLE ALUMINUM PROFILES

SURFACE PROFILES

ALU-SF

LENGTHS 39" | 78" | 84" | 98"
LENS Clear, Frosted
FINISH Black | Silver

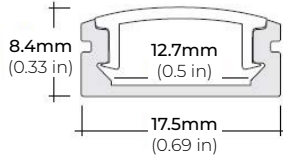

ALU-CN (CORNER)

LENGTHS 39" | 78" | 84" | 96"
LENS Clear, Frosted
FINISH Silver

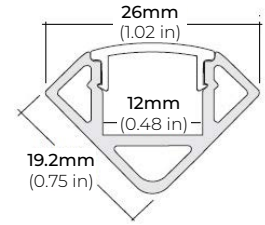

ALU-DS100

LENGTHS 39" | 78" | 84"
LENS Clear, Frosted
FINISH Silver

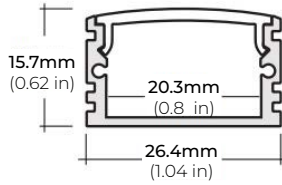

ALP-20

LENGTHS 49" | 84" | 98"
LENS Frosted
FINISH White | Black | Silver

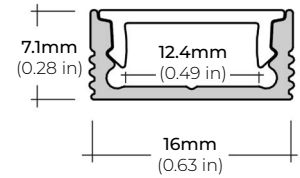

ALP-35

LENGTHS 48" | 96"
LENS Frosted
FINISH White | Black | Silver

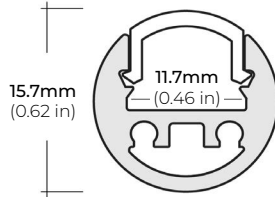

ALP-50C (CORNER)

LENGTHS 48" | 84" | 98"
LENS Frosted
FINISH Black | Silver

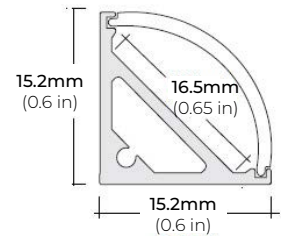

ALP-60

LENGTHS 49" | 84" | 98"
LENS Frosted
FINISH White | Black | Silver

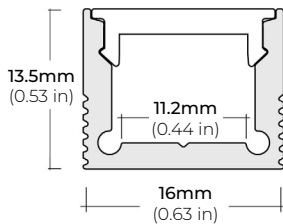

ALP-65

LENGTHS 48" | 84"
LENS Clear
FINISH Silver

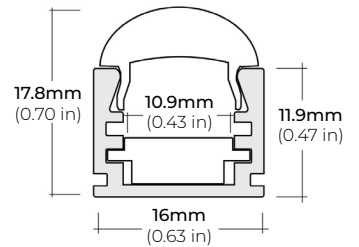

ALP-70

LENGTHS 49" | 84" | 98"
LENS Frosted
FINISH Black | Silver

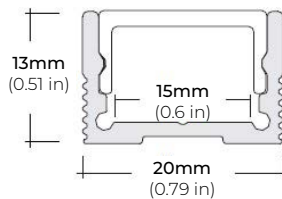

ALP-80

LENGTHS 49" | 98"
LENS Frosted
FINISH Silver

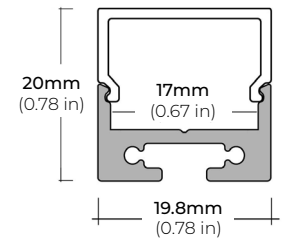

* For more compatible profiles, visit corelightingusa.com

RECESSED PROFILES

ALP-20R

LENGTHS 49" | 98"
LENS Frosted
FINISH White | Black | Silver

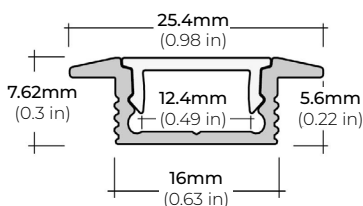

ALP-60R

LENGTHS 49" | 84" | 98"
LENS Frosted
FINISH White | Black | Silver

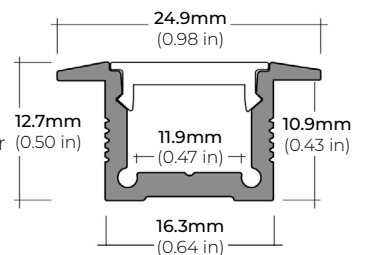

* For more compatible profiles, visit corelightingusa.com

LSP-50

4.4W INDOOR FLEXIBLE LED STRIP

COMPATIBLE TRANSFORMERS

PSDL SERIES TRIAC DIMMABLE

PSDL-30W-12V	CLASS 2	6.5" X 3.63" X 1.58"
PSDL-60W-12V	CLASS 2	7.4" X 3.63" X 1.58"
PSDL-100W-12V	CLASS 2	8.67" X 3.67 X 1.62"
PSDL-150W-12V		10.25" X 4.06" X 1.82"
PSDL-200W-12V		10.25" X 4.06" X 1.82"
PSDL-300W-12V		10.25" X 4.06" X 1.82"

PSDL-30W-24V	CLASS 2	6.5" X 3.63" X 1.58"
PSDL-60W-24V	CLASS 2	7.4" X 3.63" X 1.58"
PSDL-96W-24V	CLASS 2	8.67" X 3.67 X 1.62"
PSDL-150W-24V		10.25" X 4.06" X 1.82"
PSDL-192W-24V	CLASS 2	11" X 4" X 1.82"
PSDL-200W-24V		10.25" X 4.06" X 1.82"
PSDL-288W-24V	CLASS 2	11.85" X 4.25" X 1.82"
PSDL-300W-24V		10.25" X 4.06" X 1.82"

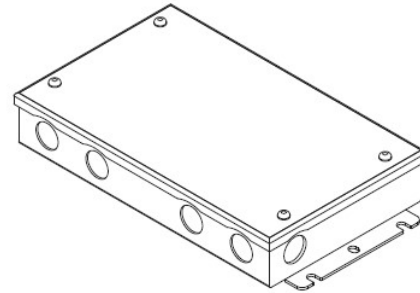

PSDH SERIES HIGH PERFORMANCE MAGNETIC LOW VOLTAGE (MLV)

PSDH-48W-24V	CLASS 2	11.25" X 3.37" X 3.25"
PSDH-96W-24V	CLASS 2	11.25" X 3.37" X 3.25"
PSDH-288W-24V	CLASS 2	14.25" X 8.43" X 4.43"

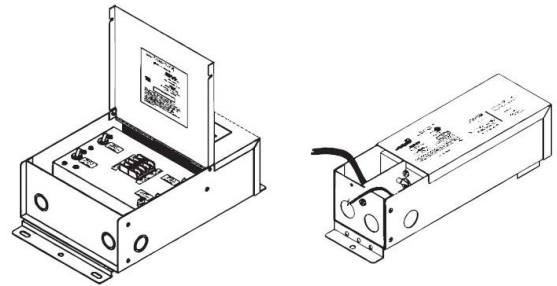

PSRX SERIES 4-IN-1 DIMMING DRIVER W/ JUNCTION BOX

PSRX-30W-12V-UNV	CLASS 2	6.5" X 3.72" X 1.57"
PSRX-60W-12V-UNV	CLASS 2	7.4" X 3.72" X 1.57"
PSRX-150W-12V-UNV		10.24" X 4.13" X 1.77"
PSRX-30W-24V-UNV	CLASS 2	6.5" X 3.7" X 1.57"
PSRX-60W-24V-UNV	CLASS 2	7.4" X 3.72" X 1.57"
PSRX-96W-24V-UNV	CLASS 2	8.66" X 3.72" X 1.57"
PSRX-150W-24V-UNV		10.24" X 4.13" X 1.77"
PSRX-200W-24V-UNV		10.24" X 4.13" X 1.77"
PSRX-300W-24V-UNV		10.94" X 4.33" X 1.77"

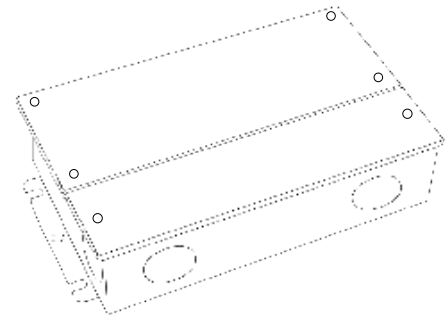

LSP-50

4.4W INDOOR FLEXIBLE LED STRIP

COMPATIBLE TRANSFORMERS

PSVT SERIES 0-10V DIMMING DRIVER

PSVT-60W-24V	CLASS 2	7.4" X 3.72" X 1.57"
PSVT-96W-24V	CLASS 2	8.66" X 3.72" X 1.57"
PSVT-200W-24V		10.24" X 4.13" X 1.77"
PSVT-288W-24V	CLASS 2	11.85" X 4.25" X 1.81"
PSVT-300W-24V		10.94" X 4.33" X 1.77"

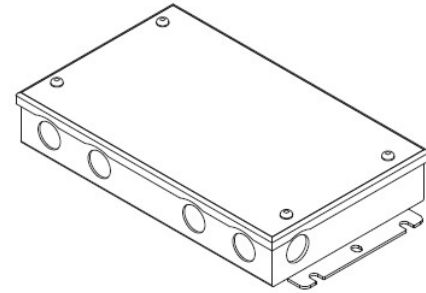

PSDE SERIES 0-10V DIMMING W/ JUNCTION BOX

PSDE-60W-24V-010-JB	CLASS 2	12.1" X 2.36" X 1.4"
PSDE-96W-24V-010-JB	CLASS 2	12.1" X 2.36" X 1.4"

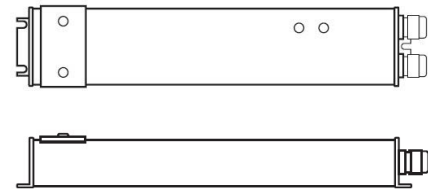

LUTRON 1% 3-WIRE DIMMING

L3DA4U1UKL-CV240	CLASS 2	4.0" X 1.5" X 4.0"
------------------	---------	--------------------

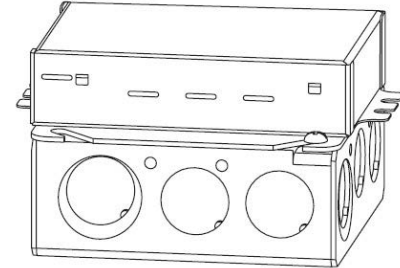

LUTRON 1% 3-WIRE DIMMING

PSDE-96W-24V-ECO	CLASS 2	10.5" X 3.0" X 2.0"
------------------	---------	---------------------

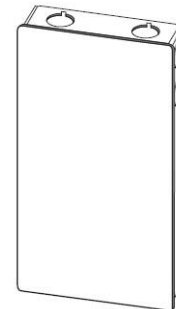

LSP-50

4.4W INDOOR FLEXIBLE LED STRIP

COMPATIBLE NON-DIMMING DRIVERS

PSHK SERIES

NON-DIMMING CONSTANT VOLTAGE WITH JUNCTION BOX

PSHK-30W-24V	CLASS 2	6.5" X 3.6" X 1.02"
PSHK-60W-24V	CLASS 2	7.4" X 3.62" X 1.02"
PSHK-96W-24V	CLASS 2	8.66" X 3.66" X 1.61"
PSHK-150W-24V		10.24" X 4.06" X 1.81"
PSHK-200W-24V		10.24" X 4.06" X 1.81"
PSHK-288W-24V	CLASS 2	11.85" X 4.25" X 1.82"
PSHK-300W-24V		10.24" X 4.25" X 1.81"

