

# LSMW-55WD

## 5.5W OUTDOOR AUTO WARM-DIM FLEXIBLE LED STRIP

Project \_\_\_\_\_  
Location \_\_\_\_\_  
Quote/ Ref # \_\_\_\_\_

**LSMW-55WD** is a new warm-dim LED strip with smart chip technology. Using a standard wall box dimmer, LED light source automatically shifts color temperature from 3000K to 1800K as it is being dimmed. LSMW-55WD provides Warm-Dim technology at a fraction of the price without the need for any special lighting control system.

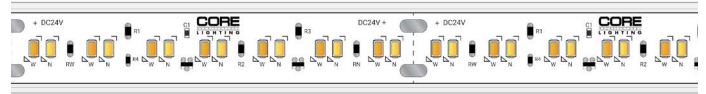

### SPECIFICATIONS

INPUT VOLTAGE	24V DC
POWER CONSUMPTION	5.5W/Ft.
NO. OF LEDS	64 LEDs per Ft.
LUMEN OUTPUT	348 Lm/Ft.
CRI	95+
DIMMING	MLV, ELV, 0-10 and TRIAC
MAXIMUM RUN LENGTH	16 Ft.
CUTTABLE	Every 2.4 in (61.1mm)
BINNING	1.5 Step Macadam Elipse
OPERATING TEMPERATURE	-40°F (-40°C) ~ 140°F (60°C)
BEAM ANGLE	120°
IP RATING	IP65 wet location (Outdoor)
CERTIFICATIONS	UL Listed, TITLE 24 JA8
LUMEN MAINTENANCE	50,000 Hrs.



MODEL	COLOR TEMP	LENGTH	VOLTAGE	PROFILE
LSMW55WD	18K/27K 1800K/2700K	16 16 Ft.	24V 24 Volts	See Page 2 for compatible profiles.
	18K/30K 1800K/3000K	1XX per Ft.		

\*1 = Custom length per FT.  
(Cuttable every 2.4")

\* Custom color finishes require powder coating. Allow 7 days leads time.

# LSMW-55WD

## 5.5W OUTDOOR AUTO WARM-DIM FLEXIBLE LED STRIP

### DIMENSIONS

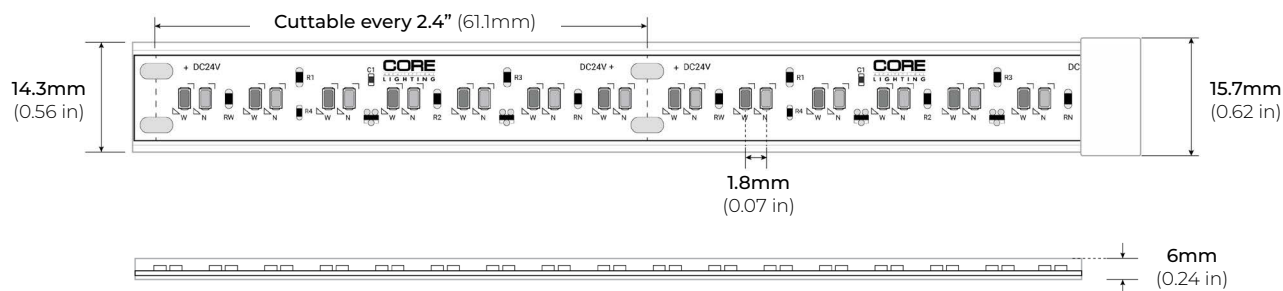

### COMPATIBLE ALUMINUM PROFILES

#### SURFACE PROFILES

##### ALU-DS100

LENGTHS 39" | 78" | 84"  
LENS Clear, Frosted  
FINISH Silver

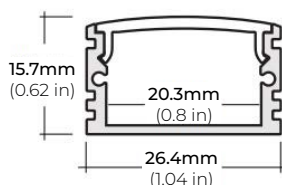

##### ALP-82

LENGTHS 49" | 98"  
LENS Frosted  
FINISH White | Black | Silver

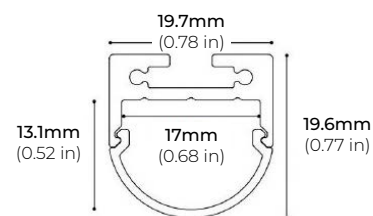

##### ALP-85

LENGTHS 48" | 98"  
LENS Frosted  
FINISH Black | Silver

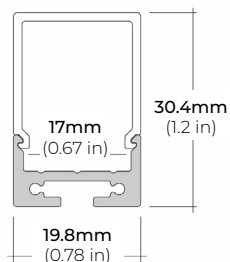

##### ALP-90

LENGTHS 48" | 96"  
LENS Frosted  
FINISH Black | Silver

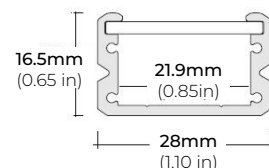

##### ALP-130

LENGTHS 49" | 84" | 98"  
LENS Frosted  
FINISH Black | Silver

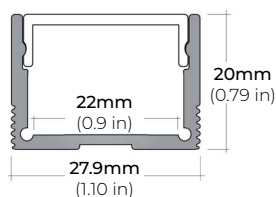

##### ALP-150LX

LENGTHS 49" | 98"  
LENS Frosted  
FINISH White | Black

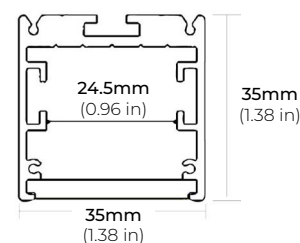

\* For more compatible profiles, visit [corelightingusa.com](http://corelightingusa.com)

#### RECESSED PROFILES

##### ALP-210RN

LENGTHS 49" | 98"  
LENS Frosted  
FINISH Silver

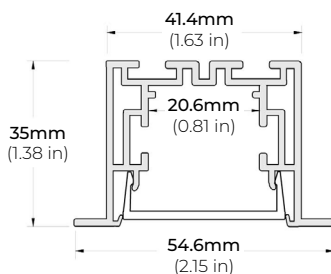

##### ALP-230RN

LENGTHS 49" | 98"  
LENS Frosted  
FINISH Silver

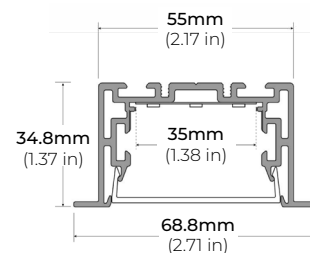

\* For more compatible profiles, visit [corelightingusa.com](http://corelightingusa.com)

# LSMW-55WD

## 5.5W OUTDOOR AUTO WARM-DIM FLEXIBLE LED STRIP

### COMPATIBLE TRANSFORMERS

#### PSDL SERIES TRIAC DIMMABLE

PSDL-30W-24V	CLASS 2	6.5" X 3.63" X 1.58"
PSDL-60W-24V	CLASS 2	7.4" X 3.63" X 1.58"
PSDL-96W-24V	CLASS 2	8.67" X 3.67 X 1.62"
PSDL-150W-24V		10.25" X 4.06" X 1.82"
PSDL-192W-24V	CLASS 2	11" X 4" X 1.82"
PSDL-200W-24V		10.25" X 4.06" X 1.82"
PSDL-288W-24V	CLASS 2	11.85" X 4.25" X 1.82"
PSDL-300W-24V		10.25" X 4.06" X 1.82"

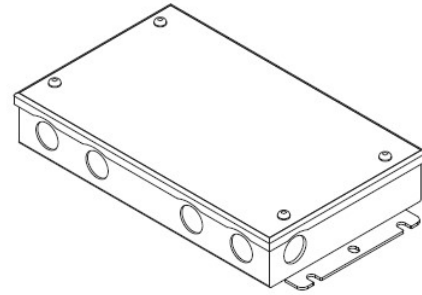

#### PSDH SERIES HIGH PERFORMANCE MAGNETIC LOW VOLTAGE (MLV)

PSDH-48W-24V	CLASS 2	11.25" X 3.38" X 3.38"
PSDH-96W-24V	CLASS 2	11.25" X 3.38" X 3.37"
PSDH-288W-24V	CLASS 2	14.25" X 8.43" X 4.43"

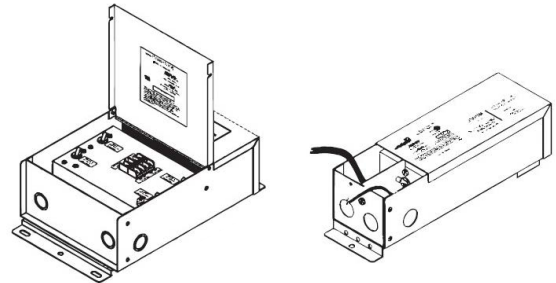

#### PSRX SERIES 4-IN-1 DIMMING DRIVER W/ JUNCTION BOX

PSRX-30W-24V-UNV	CLASS 2	6.5" X 3.7" X 1.57"
PSRX-60W-24V-UNV	CLASS 2	7.4" X 3.72" X 1.57"
PSRX-96W-24V-UNV	CLASS 2	8.66" X 3.72" X 1.57"
PSRX-150W-24V-UNV		10.24" X 4.13" X 1.77"
PSRX-200W-24V-UNV		10.24" X 4.13" X 1.77"
PSRX-300W-24V-UNV		10.94" X 4.33" X 1.77"

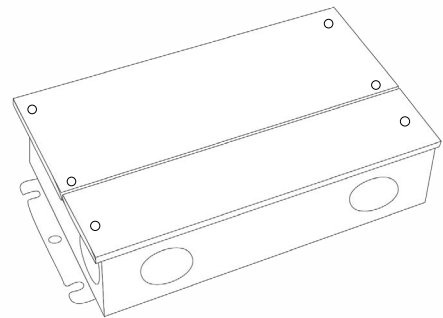

#### PSVT SERIES 0-10V DIMMING WITH JUNCTION BOX

PSVT-60W-24V-UNV-010	CLASS 2	7.4" X 3.72" X 1.57"
PSVT-96W-24V-UNV-010	CLASS 2	8.66" X 3.72" X 1.57"
PSVT-200W-24V-UNV-010		10.24" X 4.13" X 1.77"
PSVT-288W-24V-UNV-010	CLASS 2	11.85" X 4.25" X 1.81"
PSVT-300W-24V-UNV-010		10.94" X 4.33" X 1.77"

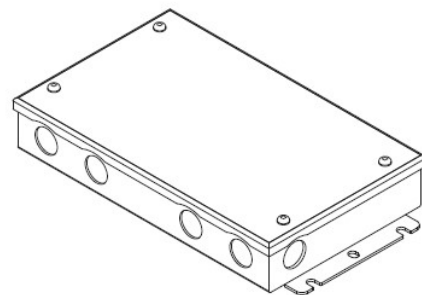

# LSMW-55WD

## 5.5W OUTDOOR AUTO WARM-DIM FLEXIBLE LED STRIP

### COMPATIBLE TRANSFORMERS

PSDE SERIES  
0-10V DIMMING W/ JUNCTION BOX

PSDE-60W-24V-010-JB	CLASS 2	12.1" X 2.36" X 1.4"
PSDE-96W-24V-010-JB	CLASS 2	12.1" X 2.36" X 1.4"

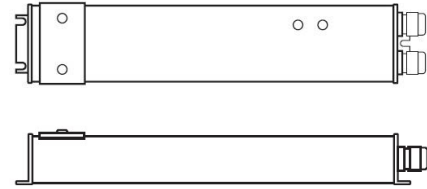

LUTRON 1%  
3-WIRE DIMMING

L3DA4U1UKL-CV240	CLASS 2	4.0" X 1.5" X 4.0"
------------------	---------	--------------------

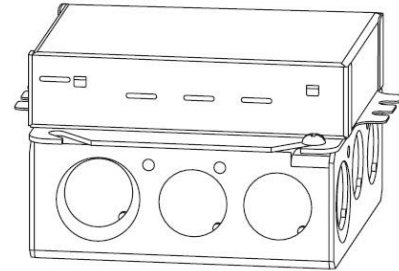

LUTRON 1%  
3-WIRE DIMMING

PSDE-96W-24V-ECO	CLASS 2	10.5" X 3.0" X 2.0"
------------------	---------	---------------------

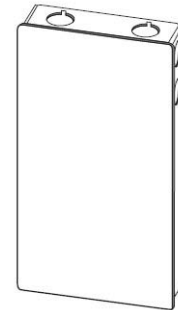

### COMPATIBLE NON-DIMMING DRIVERS

PSHK SERIES  
NON-DIMMING CONSTANT VOLTAGE WITH JUNCTION BOX

PSHK-30W-24V	CLASS 2	6.5" X 3.6" X 1.02"
PSHK-60W-24V	CLASS 2	7.4" X 3.62" X 1.02"
PSHK-96W-24V	CLASS 2	8.66" X 3.66" X 1.61"
PSHK-150W-24V		10.24" X 4.06" X 1.81"
PSHK-200W-24V		10.24" X 4.06" X 1.81"
PSHK-288W-24V	CLASS 2	11.85" X 4.25" X 1.82"
PSHK-300W-24V		10.24" X 4.25" X 1.81"

