

LSM-105

10W HIGH OUTPUT INDOOR FLEXIBLE LED STRIP

Project _____

Location _____

Quote/ Ref # _____

LSM-105 is a high-output, double-row LED strip designed to produce up to 937 Lm/Ft. at 10W/Ft. This field cuttable LED strip features a low profile design that allows it to be attached almost anywhere. Installation is quick and easy. It produces a 120° light beam spread and is available in different color temperatures to fit your specific needs.

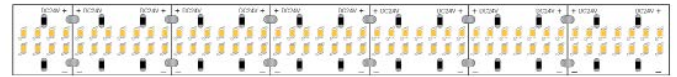

SPECIFICATIONS

INPUT VOLTAGE	24V DC
POWER CONSUMPTION	10W/Ft.
NO. OF LEDS	108 LEDs per Ft.
LUMEN OUTPUT	Up to 937 Lm/Ft.
CRI	98+
COLOR TEMPERATURE	22K/ 25K/ 27K/ 30K/ 35K/ 40K
DIMMING	MLV, ELV, 0-10V and TRIAC
MAXIMUM RUN LENGTH	10 Ft.
CUTTABLE	Every 1.04 in (26.4mm)
BINNING	1.5-Step MacAdam Elipse
OPERATING TEMPERATURE	-40°F (-40°C) to 140°F (+60°C)
BEAM ANGLE	120°
IP RATING	Indoor
CERTIFICATIONS	UL Listed, California TITLE JA8
LUMEN MAINTENANCE	50,000 Hrs.

LUMENS

CCT	LM/ FT	CRI	R9	R13
2200K	762	95	89	97
2500K	783	95	89	97
2700K	854	97	90	100
3000K	895	96	97	96
3500K	916	94	86	95
4000K	937	95	95	96

*Approved for closet / storage space installation per NEC 410.16(A)(3) and 410.16(C)(5)



MODEL	COLOR TEMP	LED LENGTH	VOLTAGE	PROFILE
LSM105	22K 2200K	16 16 Ft.	24 24V DC	See Page 2 for compatible profiles.
	25K 2500K	100 100 Ft.		
	27K 2700K	1XX per Ft.		
	30K 3000K			
	35K 3500K			
	40K 4000K			
		*1 = Custom length per FT. (Cutttable every 1.04")		* Custom color finishes require powder coating. Allow 7 days leads time.

LSM-105

10W HIGH OUTPUT INDOOR FLEXIBLE LED STRIP

DIMENSIONS

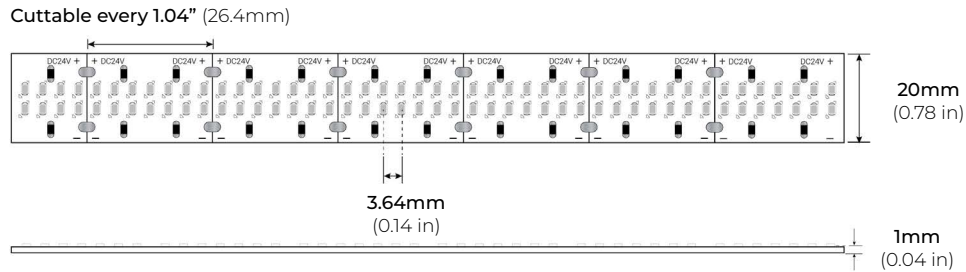

COMPATIBLE ALUMINUM PROFILES

SURFACE PROFILES

ALU-DS100

LENGTHS 39" | 78" | 84"
LENS Clear, Frosted
FINISH Silver

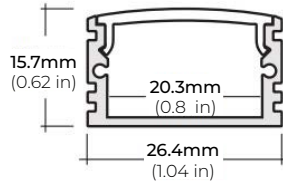

ALP-90

LENGTHS 48" | 96"
LENS Frosted
FINISH Silver

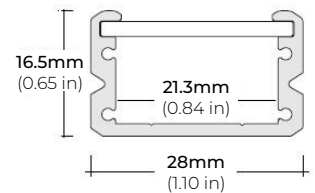

ALP-102

LENGTHS 49" | 98"
LENS Frosted, Black, Asymmetric, Double Asymmetric
FINISH Black | Silver | White

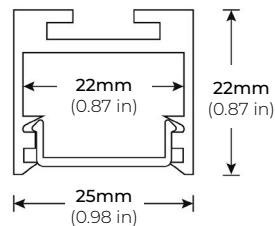

ALP-130

LENGTHS 49" | 84" | 98"
LENS Frosted
FINISH Silver

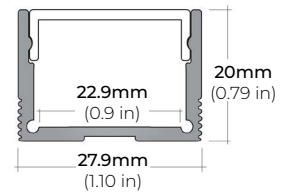

ALP-140

LENGTHS 48" | 98"
LENS Frosted
FINISH Silver

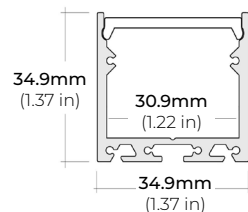

ALP-160

LENGTHS 49" | 98"
LENS Frosted
FINISH Silver

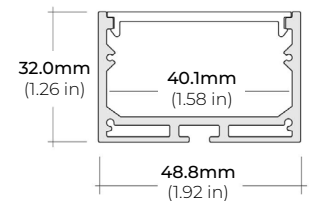

* For more compatible profiles, visit corelightingusa.com

RECESSED PROFILES

ALP-210RN

LENGTHS 49" | 98"
LENS Frosted
FINISH Silver

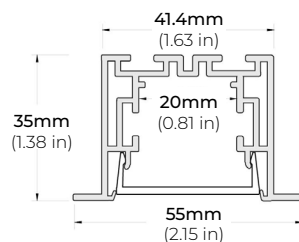

ALP-340R

LENGTHS 49" | 98"
LENS Frosted
FINISH Silver

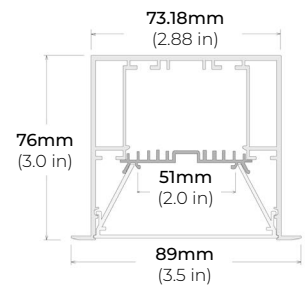

* For more compatible profiles, visit corelightingusa.com

LSM-105

10W HIGH OUTPUT INDOOR FLEXIBLE LED STRIP

COMPATIBLE TRANSFORMERS

PSDL SERIES TRIAC DIMMABLE

PSDL-30W-24V	CLASS 2	6.5" X 3.63" X 1.03"
PSDL-60W-24V	CLASS 2	7.4" X 3.63" X 1.03"
PSDL-96W-24V	CLASS 2	8.67" X 3.67" X 1.62"
PSDL-150W-24V		8.67" X 3.67" X 1.62"
PSDL-192W-24V	CLASS 2	10.25" X 4.06" X 1.82"
PSDL-200W-24V		10.25" X 4.06" X 1.82"
PSDL-288W-24V	CLASS 2	10.25" X 4.06" X 1.82"
PSDL-300W-24V		10.25" X 4.06" X 1.82"

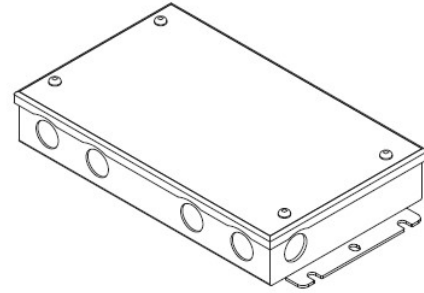

PSDH SERIES HIGH PERFORMANCE MAGNETIC LOW VOLTAGE (MLV)

PSDH-48W-24V	CLASS 2	11.25" X 3.37" X 3.25"
PSDH-96W-24V	CLASS 2	11.25" X 3.37" X 3.25"
PSDH-288W-24V	CLASS 2	14.25" X 8.43" X 4.43"

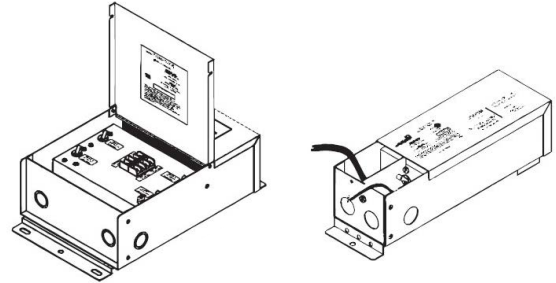

PSRX SERIES 4-IN-1 DIMMING DRIVER

PSRX-30W-24V	CLASS 2	6.5" X 3.72" X 1.57"
PSRX-60W-24V	CLASS 2	7.4" X 3.72" X 1.57"
PSRX-96W-24V	CLASS 2	8.66" X 3.72" X 1.57"
PSRX-150W-24V		10.24" X 4.13" X 1.77"
PSRX-192W-24V	CLASS 2	11" X 4" X 1.82"
PSRX-200W-24V		10.24" X 4.13" X 1.77"
PSRX-288W-24V	CLASS 2	11.85" X 4.25" X 1.82"
PSRX-300W-24V		10.94" X 4.33" X 1.77"

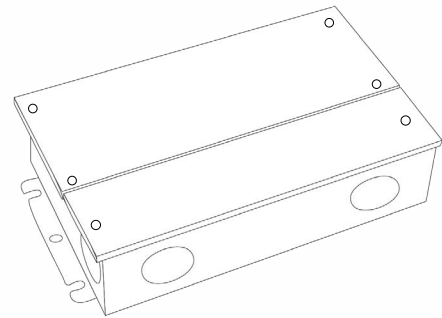

PSVT SERIES 0-10V DIMMING DRIVER

PSVT-60W-24V	CLASS 2	7.4" X 3.72" X 1.57"
PSVT-96W-24V	CLASS 2	8.66" X 3.72" X 1.57"
PSVT-200W-24V		10.24" X 4.13" X 1.77"
PSVT-288W-24V	CLASS 2	11.85" X 4.25" X 1.81"
PSVT-300W-24V		10.94" X 4.33" X 1.77"

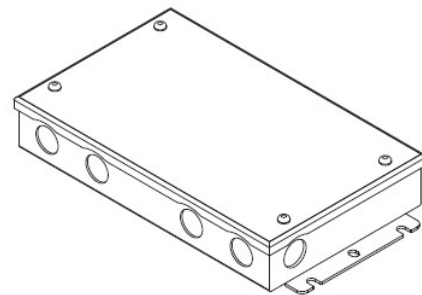

LSM-105

10W HIGH OUTPUT INDOOR FLEXIBLE LED STRIP

COMPATIBLE TRANSFORMERS

PSDE SERIES
0-10V DIMMING W/ JUNCTION BOX

PSDE-60W-24V-010-JB CLASS 2 12.1" X 2.36" X 1.4"
PSDE-96W-24V-010-JB CLASS 2 12.1" X 2.36" X 1.4"

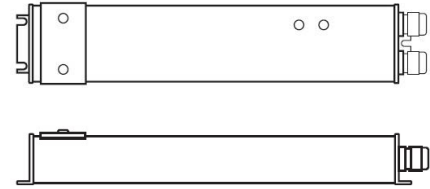

LUTRON 1%
3-WIRE DIMMING

L3DA4U1UKL-CV240 CLASS 2 4.0" X 1.5" X 4.0"

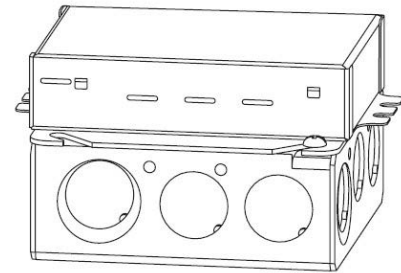

LUTRON 1%

PSDE-96W-24V-ECO CLASS 2 10.5" X 3.0" X 2.0"

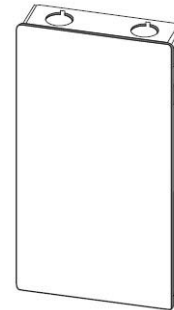

COMPATIBLE NON-DIMMING DRIVERS

PSHK SERIES
NON-DIMMING CONSTANT VOLTAGE WITH JUNCTION BOX

PSHK-30W-24V CLASS 2 6.5" X 3.6" X 1.02"
PSHK-60W-24V CLASS 2 7.4" X 3.62" X 1.02"
PSHK-96W-24V CLASS 2 8.66" X 3.66" X 1.61"
PSHK-150W-24V 10.24" X 4.06" X 1.81"
PSHK-200W-24V 10.24" X 4.06" X 1.81"
PSHK-288W-24V CLASS 2 11.85" X 4.25" X 1.82"
PSHK-300W-24V 10.24" X 4.25" X 1.81"

