

# LNE-50

## 5.3W IP54/ IP67 FLEXIBLE LED NEON SERIES

Project \_\_\_\_\_  
Location \_\_\_\_\_  
Quote/ Ref # \_\_\_\_\_

The **LNE-50 Series** is a high performance flexible and affordable LED fixture designed as a neon replacement and is also useful in a wide variety of indoor or outdoor applications where a smooth surface or continuous line of light is desired. It is a flexible strip light that can bend around contours or tight curves horizontally or vertically without being damaged.

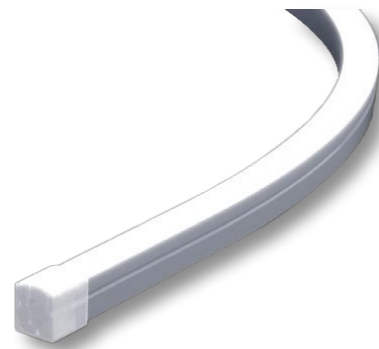

### SPECIFICATIONS

<b>POWER CONSUMPTION</b>	5.3W per Ft.
<b>LUMEN OUTPUT</b>	380 Lumens per Ft. (30K)
<b>CRI</b>	90+
<b>COLOR TEMPERATURE</b>	24K/ 27K/ 30K/ 35K/ 40K/ 50K RD/ GN/ BL/ AM/ PK/ YW
<b>DIMMING/ CONTROL</b>	MLV, ELV, 0-10 and TRIAC
<b>MAXIMUM RUN LENGTH</b>	32 Ft.
<b>CUTTABLE</b>	Every 1.9 in. (50mm)
<b>OPERATING VOLTAGE</b>	24V DC
<b>STORAGE TEMPERATURE</b>	-40°F (-40°C) to 176°F (80°C)
<b>OPERATING TEMPERATURE</b>	-4°F (-20°C) to 113°F (45°C)
<b>HUMIDITY</b>	0-95% Non-Condensing
<b>BEAM ANGLE</b>	120°
<b>IP RATING</b>	IP54/ IP67
<b>CERTIFICATIONS</b>	UL Listed
<b>LUMEN MAINTENANCE</b>	50,000 Hrs.

### FEATURES

- High color consistency and smooth illumination
- Multiple CCT options available
- Continuous run length up to 32 Ft.
- Cuttable every 1.9 in. (50mm)
- Bottom, Side and End Feed options
- UL Listed



MODEL	LIGHT SURFACE	COLOR TEMP	VOLT	LENGTH	IP RATING	POWER FEED	FEED LENGTH	
LNE-50	<b>TP</b> Top Bend	<b>24K</b> 2400K	<b>RD</b> Red	<b>24</b> 24V DC	<b>1'X</b> per Ft.	<b>IP54</b> Damp	<b>HW3</b> 3 Ft. Power Feed	
	<b>SB</b> Side Bend	<b>27K</b> 2700K	<b>GN</b> Green				<b>IP67</b> Wet	<b>SFL</b> Side Feed Left
		<b>30K</b> 3000K	<b>BL</b> Blue			<b>SFR</b> Side Feed Right		<b>HW15</b> 15 Ft. Power Feed
		<b>35K</b> 3500K	<b>AM</b> Amber			<b>EF</b> End Feed		<b>HW30</b> 30 Ft. Power Feed
		<b>40K</b> 4000K	<b>PK</b> Pink					<b>HW50</b> 50 Ft. Power Feed
	<b>50K</b> 5000K	<b>YW</b> Yellow						

\*1' = Custom length per FT. (cuttable every 1.9")

# LNE-50

## 5.3W IP54/ IP67 FLEXIBLE LED NEON SERIES

### DIMENSIONS

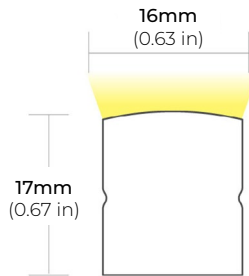

LNE-50-TP (TOP BEND)

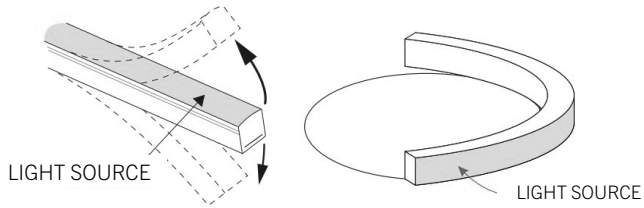

LNE-50-SB (SIDE BEND)

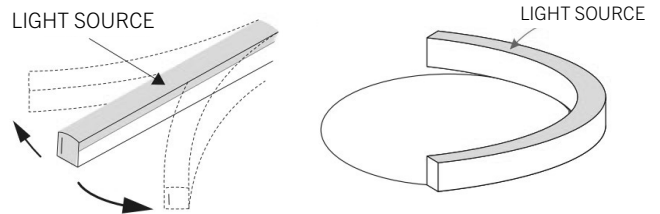

### COMPATIBLE ACCESSORIES

#### SELF LOCKING ALUMINUM PROFILE

LNE50-AC2  
2" PROFILE

LNE50-AC39  
39" PROFILE



# LNE-50

## 5.3W IP54/ IP67 FLEXIBLE LED NEON SERIES

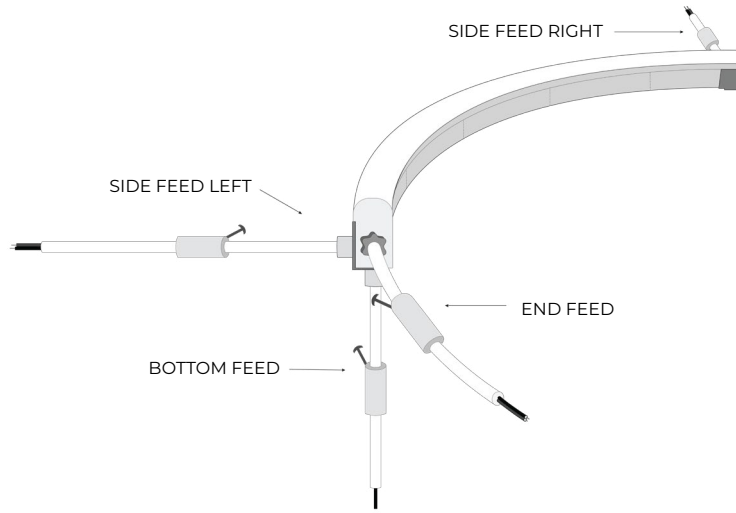

### POWER FEED (IP54)

BF  
BOTTOM FEED

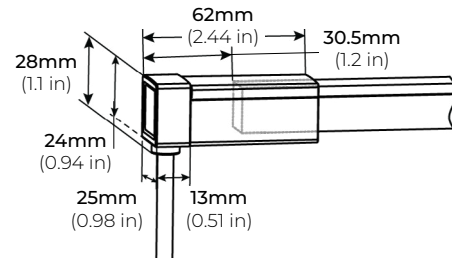

SFL  
SIDE LEFT FEED

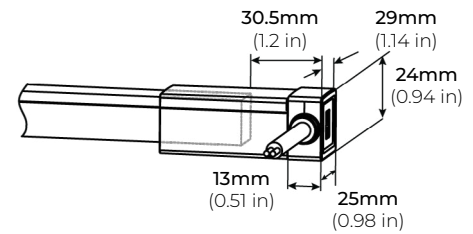

SFR  
SIDE RIGHT FEED

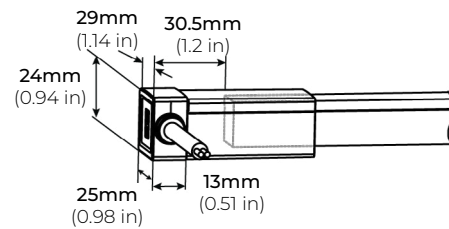

EF  
END FEED

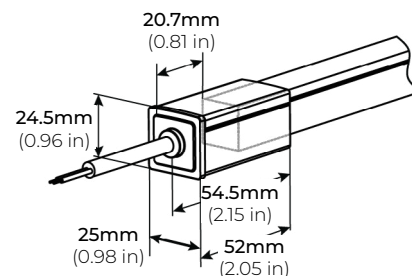

# LNE-50

## 5.3W IP54/ IP67 FLEXIBLE LED NEON SERIES

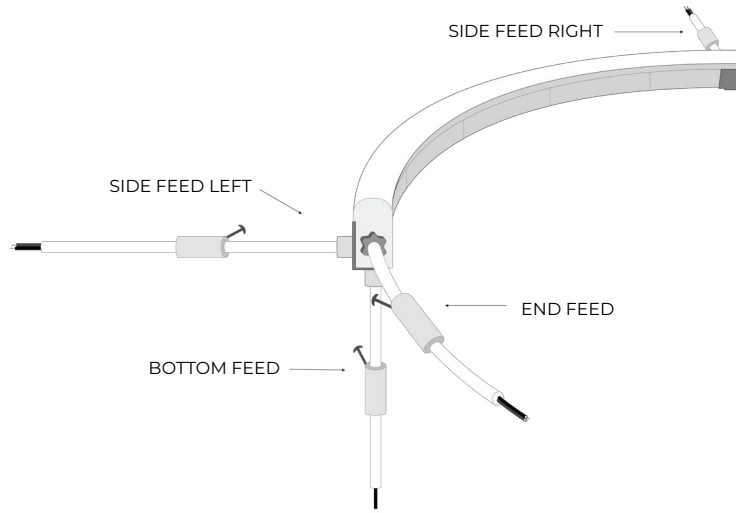

### POWER FEED (IP67)

**BF**  
BOTTOM FEED

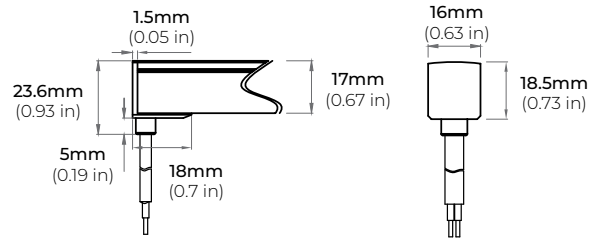

**SFL**  
SIDE LEFT FEED

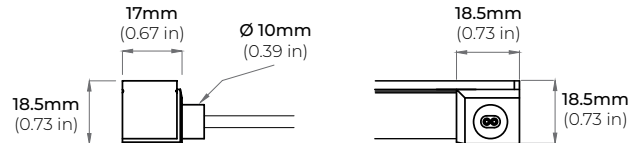

**SFR**  
SIDE RIGHT FEED

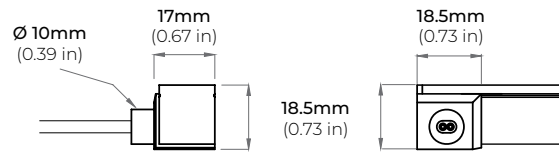

**EF**  
END FEED

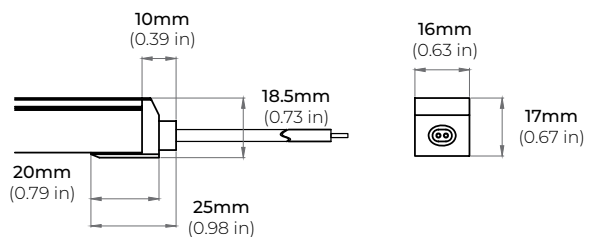

# LNE-50

## 5.3W IP54/ IP67 FLEXIBLE LED NEON SERIES

### COMPATIBLE TRANSFORMERS

#### PSDL SERIES TRIAC DIMMABLE

PSDL-30W-24V	CLASS 2	6.5" X 3.63" X 1.03"
PSDL-60W-24V	CLASS 2	7.4" X 3.63" X 1.03"
PSDL-96W-24V	CLASS 2	8.67" X 3.67" X 1.62"
PSDL-150W-24V		8.67" X 3.67" X 1.62"
PSDL-192W-24V	CLASS 2	10.25" X 4.06" X 1.82"
PSDL-200W-24V		10.25" X 4.06" X 1.82"
PSDL-288W-24V	CLASS 2	10.25" X 4.06" X 1.82"
PSDL-300W-24V		10.25" X 4.06" X 1.82"

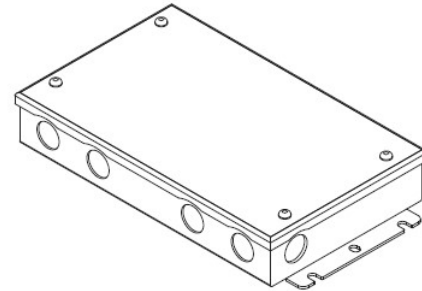

#### PSDH SERIES HIGH PERFORMANCE MAGNETIC LOW VOLTAGE (MLV)

PSDH-48W-24V	CLASS 2	11.25" X 3.37" X 3.25"
PSDH-96W-24V	CLASS 2	11.25" X 3.37" X 3.25"
PSDH-288W-24V	CLASS 2	14.25" X 8.43" X 4.43"

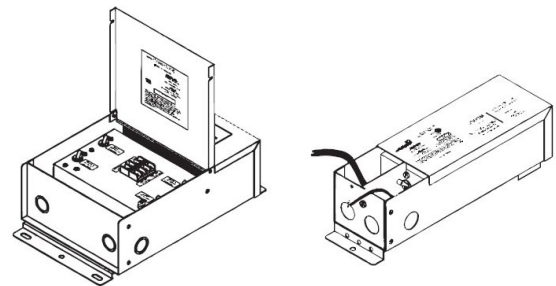

#### PSRX SERIES 4-IN-1 DIMMING DRIVER

PSRX-30W-24V	CLASS 2	6.5" X 3.72" X 1.57"
PSRX-60W-24V	CLASS 2	7.4" X 3.72" X 1.57"
PSRX-96W-24V	CLASS 2	8.66" X 3.72" X 1.57"
PSRX-150W-24V		10.24" X 4.13" X 1.77"
PSRX-192W-24V	CLASS 2	11" X 4" X 1.82"
PSRX-200W-24V		10.24" X 4.13" X 1.77"
PSRX-288W-24V	CLASS 2	11.85" X 4.25" X 1.82"
PSRX-300W-24V		10.94" X 4.33" X 1.77"

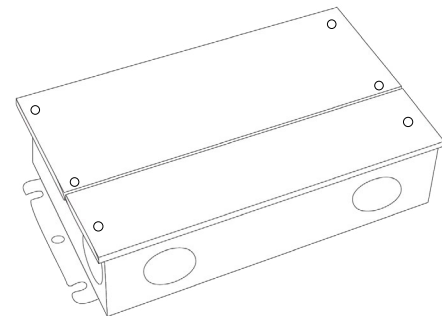

#### PSVT SERIES 0-10V DIMMING DRIVER

PSVT-60W-24V	CLASS 2	7.4" X 3.72" X 1.57"
PSVT-96W-24V	CLASS 2	8.66" X 3.72" X 1.57"
PSVT-200W-24V		10.24" X 4.13" X 1.77"
PSVT-288W-24V	CLASS 2	11.85" X 4.25" X 1.81"
PSVT-300W-24V		10.94" X 4.33" X 1.77"

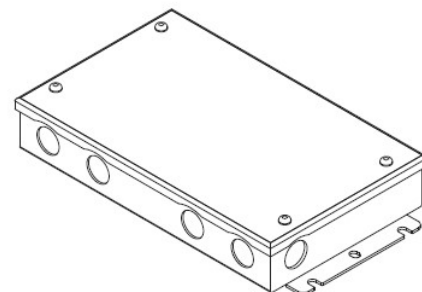

# LNE-50

## 5.3W IP54/ IP67 FLEXIBLE LED NEON SERIES

### COMPATIBLE TRANSFORMERS

#### PSDE SERIES

0-10V DIMMING W/ JUNCTION BOX

PSDE-60W-24V-010-JB	CLASS 2	12.1" X 2.36" X 1.4"
PSDE-96W-24-010-JB	CLASS 2	12.1" X 2.36" X 1.4"

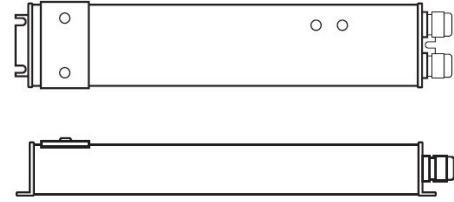

#### LUTRON 1%

3-WIRE DIMMING

L3DA4U1UKL-CV240	CLASS 2	4.89" X 4" X 2.62"
------------------	---------	--------------------

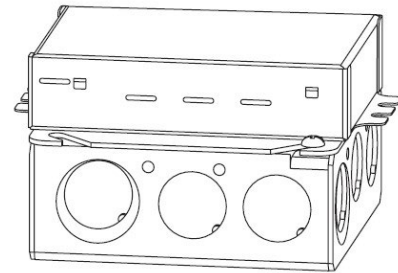

PSDE-96W-24V-ECO	CLASS 2	10.5" X 3.0" X 2.0"
------------------	---------	---------------------

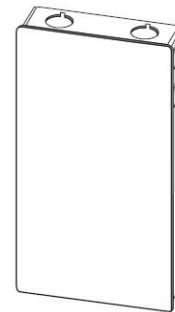

### COMPATIBLE NON-DIMMING DRIVERS

#### PSHK SERIES

NON-DIMMING CONSTANT VOLTAGE WITH JUNCTION BOX

PSHK-30W-24V	CLASS 2	6.5" X 3.6" X 1.02"
PSHK-60W-24V	CLASS 2	7.4" X 3.62" X 1.02"
PSHK-96W-24V	CLASS 2	8.66" X 3.66" X 1.61"
PSHK-150W-24V		10.24" X 4.06" X 1.81"
PSHK-200W-24V		10.24" X 4.06" X 1.81"
PSHK-288W-24V	CLASS 2	11.85" X 4.25" X 1.82"
PSHK-300W-24V		10.24" X 4.25" X 1.81"

