

# LNE-15 DUAL BEND

## 2.5W IP67 FLEXIBLE LED NEON SERIES

Project \_\_\_\_\_

Location \_\_\_\_\_

Quote/ Ref # \_\_\_\_\_

The **LNE-15 Dual Bend** is a flexible LED fixture that offers both high performance and affordability. Specifically designed a neon replacement, this fixture can bend **horizontally and vertically** around contours or tight curves without risk of damage. Able to provide up to 32 feet of continuous line of light, it's an ideal choice for indoor or outdoor applications where a sleek, smooth surface is desired.



### SPECIFICATIONS

POWER CONSUMPTION	Up to 2.5W per Ft.
LUMEN OUTPUT	Up to 210 Lumens per Ft.
CRI	90+
COLOR TEMPERATURE	27K/ 30K/ 35K/ 40K/ 50K
DIMMING/ CONTROL	MLV, ELV, 0-10 and TRIAC
MAXIMUM RUN LENGTH	32 Ft.
CUTTABLE	Every 3.94 in. (100mm)
OPERATING VOLTAGE	24V DC
STORAGE TEMPERATURE	-40°F (-40°C) to 176°F (80°C)
OPERATING TEMPERATURE	-4°F (-20°C) to 113°F (45°C)
BEAM ANGLE	120°
IP RATING	IP67
CERTIFICATIONS	UL Listed
LUMEN MAINTENANCE	50,000 Hrs.

### FEATURES

- High color consistency and smooth illumination
- Multiple CCT options available
- Continuous run length up to 32 Ft.
- Cuttable every 3.94 in. (100mm)
- Bottom, Side and End Feed options
- UL Listed

### LUMENS

CCT	LM/W	LM/ FT.
2700K	72	180
3000K	73	183
4000K	84	210



MODEL	COLOR TEMP	VOLTAGE	LENGTH	POWER FEED	FEED LENGTH
LNE15-DB	<b>27K</b> 2700K	<b>24</b> 24V DC	Please refer to pages 4 for exact lengths with corresponding ordering codes.	<b>BF</b> Bottom Feed	<b>HW3</b> 3 Ft. Power Feed
	<b>30K</b> 3000K			<b>SFL</b> Side Feed Left	<b>HW10</b> 10 Ft. Power Feed
	<b>35K</b> 3500K			<b>SFR</b> Side Feed Right	<b>HW15</b> 15 Ft. Power Feed
	<b>40K</b> 4000K			<b>EF</b> End Feed	<b>HW30</b> 30 Ft. Power Feed
	<b>50K</b> 5000K			<b>HW50</b> 50 Ft. Power Feed	

# LNE-15 DUAL BEND

## 2.5W IP67 FLEXIBLE LED NEON SERIES

### DIMENSIONS

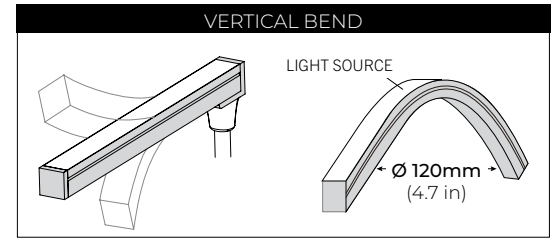
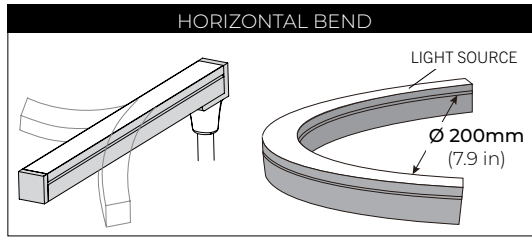
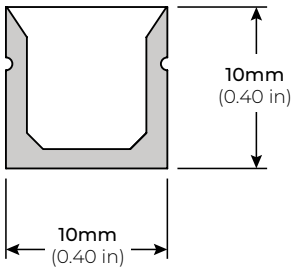

### LIGHT DISTRIBUTION

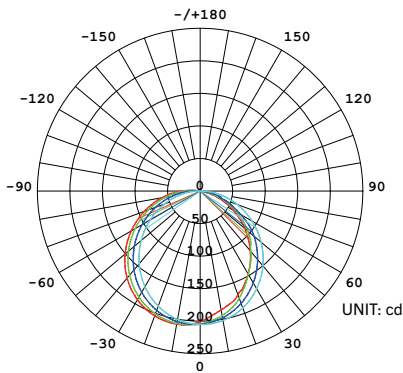

AVERAGE BEAM ANGLE (50%): 111.6°

- c0/180, 111.3 lc= 207.7
- c30/210, 111.4 lc= 206.6
- c60/240, 112.0 lc= 205.2
- c90/270, 111.9 lc= 205.0

LNE15-DB-27K

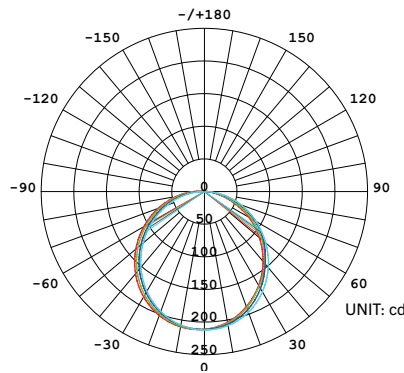

AVERAGE BEAM ANGLE (50%): 111.5°

- c0/180, 111.7 lc= 211.7
- c30/210, 112.0 lc= 211.3
- c60/240, 111.6 lc= 211.3
- c90/270, 110.6 lc= 212.1

LNE15-DB-30K

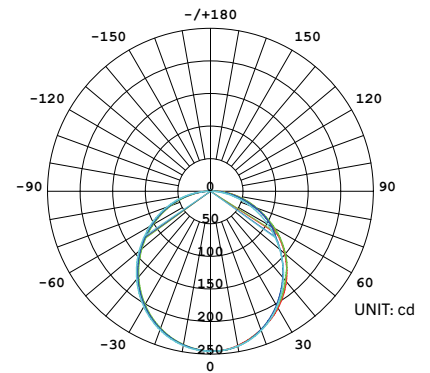

AVERAGE BEAM ANGLE (50%): 110.9°

- c0/180, 111.7 lc= 245.4
- c30/210, 112.0 lc= 245.4
- c60/240, 109.8 lc= 245.3
- c90/270, 110.0 lc= 245.5

LNE15-DB-40K

### COMPATIBLE ACCESSORIES

#### SELF LOCKING ALUMINUM PROFILE

LNE15-AC2  
2" PROFILE

LNE15-AC39  
39" PROFILE

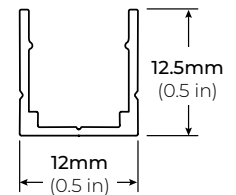
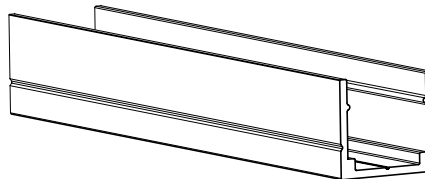

#### FLEXIBLE ALUMINUM PROFILE

LNE15-AFX  
39" PROFILE

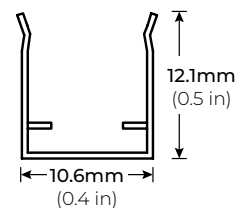
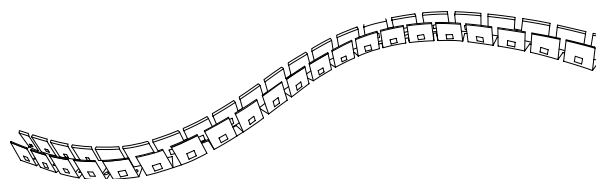

# LNE-15 DUAL BEND

## 2.5W IP67 FLEXIBLE LED NEON SERIES

### POWER FEEDS

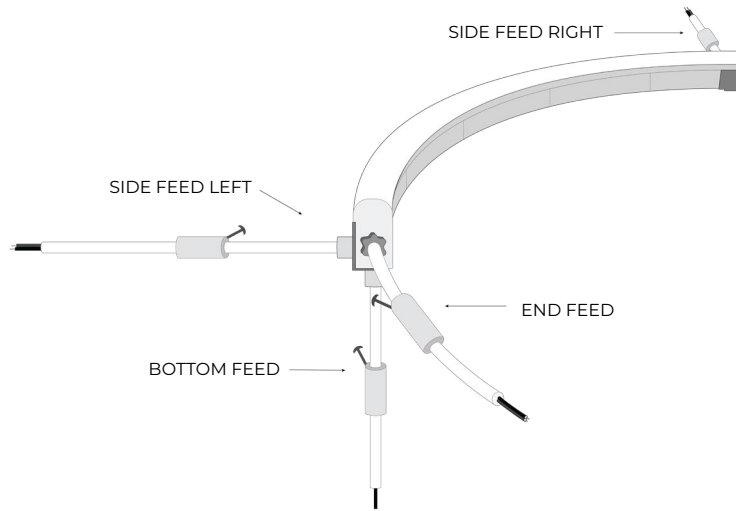

**BF**  
BOTTOM FEED

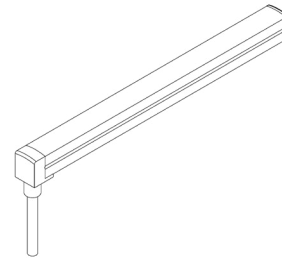

**SFL**  
SIDE LEFT FEED

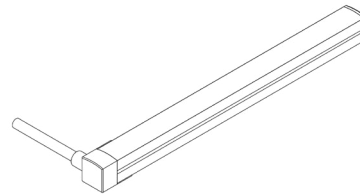

**SFR**  
SIDE RIGHT FEED

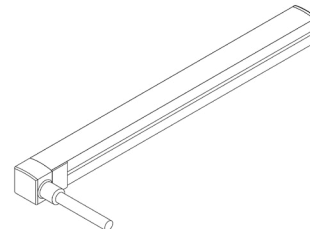

**EF**  
END FEED

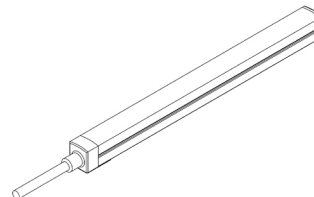

# LNE-15 DUAL BEND



## 2.5W IP67 FLEXIBLE LED NEON SERIES

### CUTTING LENGTH CODES

LNE-15 Dual Bend is cuttable every 3.94" (10CM). Please refer to the chart below to determine actual lengths once LED is cut versus actual lengths required or specified.

Total Length Calculation = Order Code Length + End Feed option Length  
**Example: 59.7" Total Length = Order Code 15 (59.1") + (0.60") End Feed**

POWER FEED OPTION	LENGTH
END FEED	0.60 INCHES

### CUTTING LENGTH INCREMENT TABLE

CODE	LENGTH (CM)	LENGTH (IN)
1	10	3.94
2	20	7.88
3	30	11.82
4	40	15.76
5	50	19.7
6	60	23.64
7	70	27.58
8	80	31.52
9	90	35.46
10	100	39.4
11	110	43.34
12	120	47.28
13	130	51.22
14	140	55.16
15	150	59.1
16	160	63.04
17	170	66.98
18	180	70.92
19	190	74.86
20	200	78.8
21	210	82.74
22	220	86.68
23	230	90.62
24	240	94.56
25	250	98.5
26	260	102.44
27	270	106.38
28	280	110.32
29	290	114.26
30	300	118.2
31	310	122.14
32	320	126.08
33	330	130.02
34	340	133.96
35	350	137.9
36	360	141.84
37	370	145.78
38	380	149.72
39	390	153.66
40	400	157.6

CODE	LENGTH (CM)	LENGTH (IN)
41	410	161.54
42	420	165.48
43	430	169.42
44	440	173.36
45	450	177.3
46	460	181.24
47	470	185.18
48	480	189.12
49	490	193.06
50	500	197
51	510	200.94
52	520	204.88
53	530	208.82
54	540	212.76
55	550	216.7
56	560	220.64
57	570	224.58
58	580	228.52
59	590	232.46
60	600	236.4
61	610	240.34
62	620	244.28
63	630	248.22
64	640	252.16
65	650	256.1
66	660	260.04
67	670	263.98
68	680	267.92
69	690	271.86
70	700	275.8
71	710	279.74
72	720	283.68
73	730	287.62
74	740	291.56
75	750	295.5
76	760	299.44
77	770	303.38
78	780	307.32
79	790	311.26
80	800	315.2

CODE	LENGTH (CM)	LENGTH (IN)
81	810	319.14
82	820	323.08
83	830	327.02
84	840	330.96
85	850	334.9
86	860	338.84
87	870	342.78
88	880	346.72
89	890	350.66
90	900	354.6
91	910	358.54
92	920	362.48
93	930	366.42
94	940	370.36
95	950	374.3
96	960	378.24
97	970	382.18

# LNE-15 DUAL BEND

## 2.5W IP67 FLEXIBLE LED NEON SERIES

### COMPATIBLE TRANSFORMERS

#### PSDL SERIES TRIAC DIMMABLE

PSDL-30W-24V	CLASS 2	6.5" X 3.63" X 1.03"
PSDL-60W-24V	CLASS 2	7.4" X 3.63" X 1.03"
PSDL-96W-24V	CLASS 2	8.67" X 3.67" X 1.62"
PSDL-150W-24V		8.67" X 3.67" X 1.62"
PSDL-192W-24V	CLASS 2	10.25" X 4.06" X 1.82"
PSDL-200W-24V		10.25" X 4.06" X 1.82"
PSDL-288W-24V	CLASS 2	10.25" X 4.06" X 1.82"
PSDL-300W-24V		10.25" X 4.06" X 1.82"

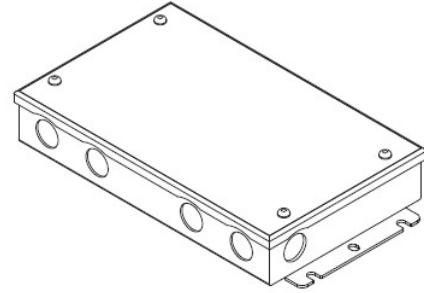

#### PSDH SERIES HIGH PERFORMANCE MAGNETIC LOW VOLTAGE (MLV)

PSDH-48W-24V	CLASS 2	11.25" X 3.37" X 3.25"
PSDH-96W-24V	CLASS 2	11.25" X 3.37" X 3.25"
PSDH-288W-24V	CLASS 2	14.25" X 8.43" X 4.43"

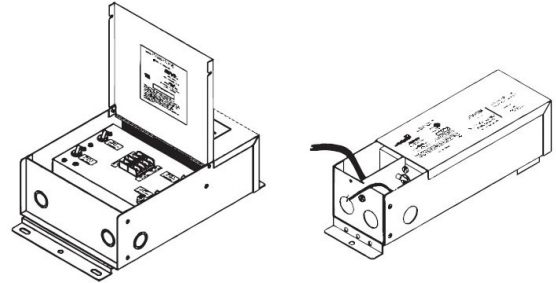

#### PSRX SERIES 4-IN-1 DIMMING DRIVER

PSRX-30W-24V	CLASS 2	6.5" X 3.72" X 1.57"
PSRX-60W-24V	CLASS 2	7.4" X 3.72" X 1.57"
PSRX-96W-24V	CLASS 2	8.66" X 3.72" X 1.57"
PSRX-150W-24V		10.24" X 4.13" X 1.77"
PSRX-192W-24V	CLASS 2	11" X 4" X 1.82"
PSRX-200W-24V		10.24" X 4.13" X 1.77"
PSRX-288W-24V	CLASS 2	11.85" X 4.25" X 1.82"
PSRX-300W-24V		10.94" X 4.33" X 1.77"

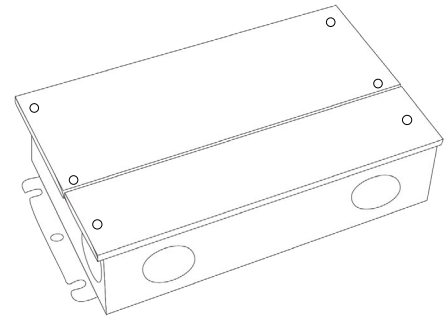

#### PSVT SERIES 0-10V DIMMING DRIVER

PSVT-60W-24V	CLASS 2	7.4" X 3.72" X 1.57"
PSVT-96W-24V	CLASS 2	8.66" X 3.72" X 1.57"
PSVT-200W-24V		10.24" X 4.13" X 1.77"
PSVT-288W-24V	CLASS 2	11.85" X 4.25" X 1.81"
PSVT-300W-24V		10.94" X 4.33" X 1.77"

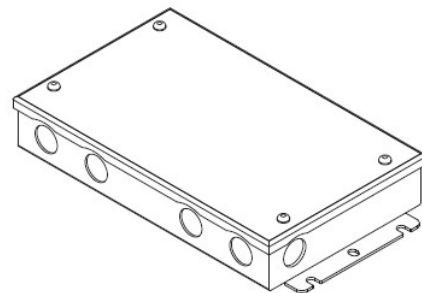

# LNE-15

## 2.5W IP67 FLEXIBLE LED NEON SERIES

### COMPATIBLE TRANSFORMERS

#### PSDE SERIES

0-10V DIMMING W/ JUNCTION BOX

PSDE-60W-24V-010-JB	CLASS 2	12.1" X 2.36" X 1.4"
PSDE-96W-24-010-JB	CLASS 2	12.1" X 2.36" X 1.4"

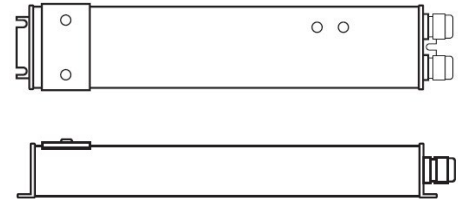

#### LUTRON 1%

3-WIRE DIMMING

L3DA4U1UKL-CV240	CLASS 2	4.0" X 1.5" X 4.0"
------------------	---------	--------------------

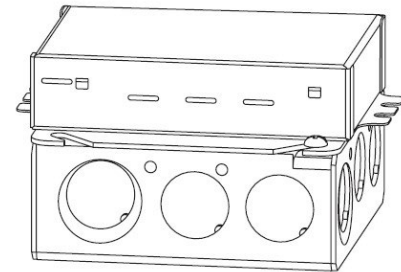

PSDE-96W-24V-ECO	CLASS 2	10.5" X 3.0" X 2.0"
------------------	---------	---------------------

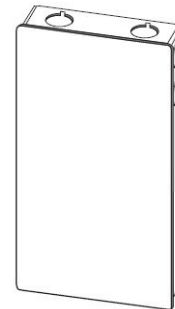

### COMPATIBLE NON-DIMMING DRIVERS

#### PSHK SERIES

NON-DIMMING CONSTANT VOLTAGE WITH JUNCTION BOX

PSHK-30W-24V	CLASS 2	6.5" X 3.6" X 1.02"
PSHK-60W-24V	CLASS 2	7.4" X 3.62" X 1.02"
PSHK-96W-24V	CLASS 2	8.66" X 3.66" X 1.61"
PSHK-150W-24V		10.24" X 4.06" X 1.81"
PSHK-200W-24V		10.24" X 4.06" X 1.81"
PSHK-288W-24V	CLASS 2	11.85" X 4.25" X 1.82"
PSHK-300W-24V		10.24" X 4.25" X 1.81"

