

LNT-45 BLACK

3.7W IP67/68 FLEXIBLE LED NEON SERIES

Project _____
Location _____
Quote/ Ref # _____

LNT-45 Black is a high performance flexible LED fixture designed as a neon replacement. Suitable for indoor and outdoor applications, the LNT-45 Black easily bends around contours and tight curves without being damaged. It allows for easy installation with its factory sealed terminators and self-locking male and female barrel connectors.



SPECIFICATIONS

INPUT VOLTAGE	24V DC Constant Voltage
POWER CONSUMPTION	3.7W per Ft.
LUMEN OUTPUT	21 Lm/ Ft.
CRI	85+
COLOR TEMPERATURE	22K/ 27K/ 30K/ 35K/ 40K/ 50K
DIMMING/ CONTROL	MLV, ELV, 0-10 and TRIAC
MAXIMUM RUN LENGTH	32 Ft.
CUTTABLE	Every 55.6mm (2.19 in)
POWER FACTOR	≤ 1
STORAGE TEMPERATURE	-40°F (-40°C) to 140°F (60°C)
OPERATING TEMPERATURE	-40°F (-40°C) to 131°F (55°C)
BEAM ANGLE	160°
HUMIDITY	0-95% Non Condensing
IP RATING	IP67/ IP68
CERTIFICATIONS	UL Listed
LUMEN MAINTENANCE	50,000 Hrs.

FEATURES

- High color consistency
- Smooth illumination
- Black Protective Jacket
- Continuous run length up to 32 Ft.
- Waterproof, submersible under water
- Bottom, Side and End Feed options
- UL Listed



MODEL	LENS	COLOR TEMP	VOLTAGE	LENGTH	POWER FEED	FEED LENGTH	
LNT-45BK	F Flat	22K 2700K	24 24V DC	Please refer to page 5 for exact lengths with corresponding ordering codes.	BF Bottom Feed	HW3 3 Ft. Power Feed	
		27K 2700K				HW10 10 Ft. Power Feed	
		30K 3000K				HW15 15 Ft. Power Feed	
		35K 3500K				SFR Side Feed Right	
		40K 4000K					EF End Feed
		50K 5000K					
60K 6000K	HW50 50 Ft. Power Feed						

LNT-45 BLACK

3.7W IP67/68 FLEXIBLE LED NEON SERIES

DIMENSIONS

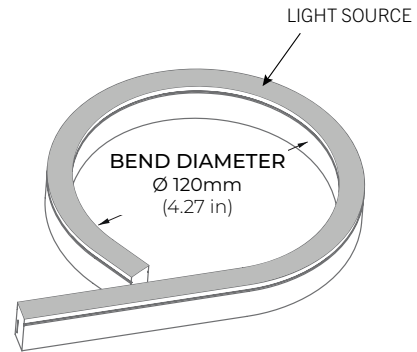
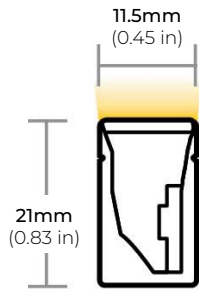

HORIZONTAL BEND

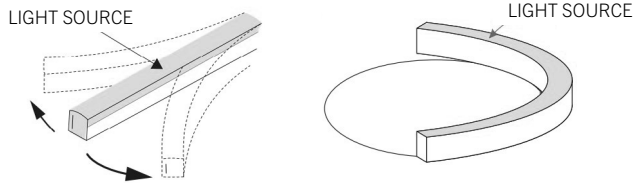

* LED strip only bends along horizontal axis. Bending the LED strip vertically (perpendicular) to the light surface risks damage to the LED strip. Do **NOT** bend more than the indicated bend radius (shown above). Doing so will damage the LED strip.

COMPATIBLE ACCESSORIES

SELF LOCKING ALUMINUM PROFILE

LNT45-AC2
2" PROFILE

LNT45-AC39
39" PROFILE

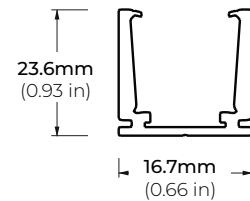
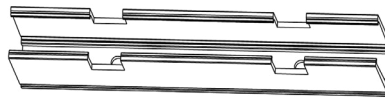

FLEXIBLE ALUMINUM CHANNEL

LNT45-AFX
39" CHANNEL

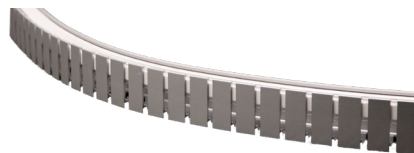

PLASTIC PROFILE

LNT45-PC39
39" PROFILE

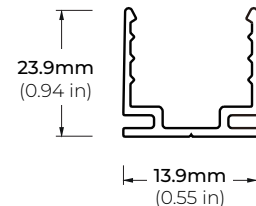

LNT45-BKT-ADJ
ADJUSTABLE BRACKET

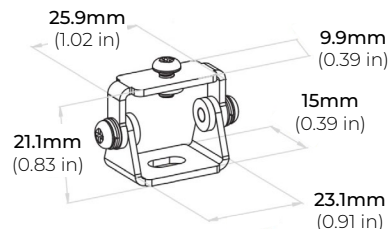

LNT-45 BLACK

3.7W IP67/68 FLEXIBLE LED NEON SERIES

COMPATIBLE ACCESSORIES

EF
END FEED

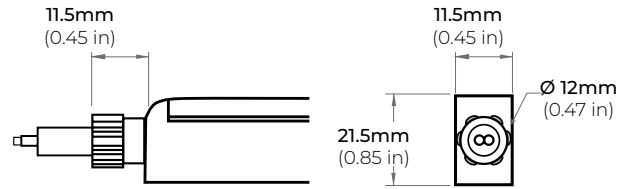
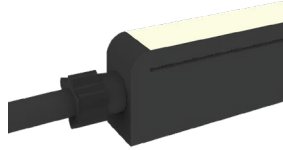

SFL
SIDE FEED LEFT

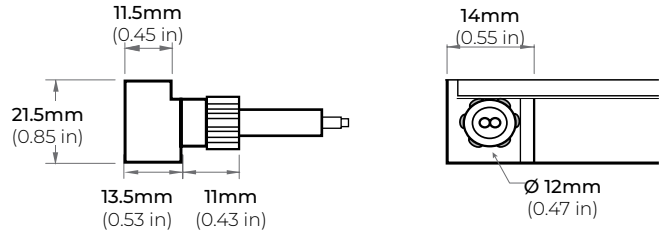
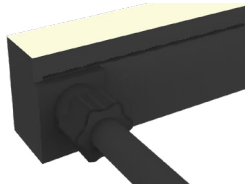

SFR
SIDE FEED RIGHT

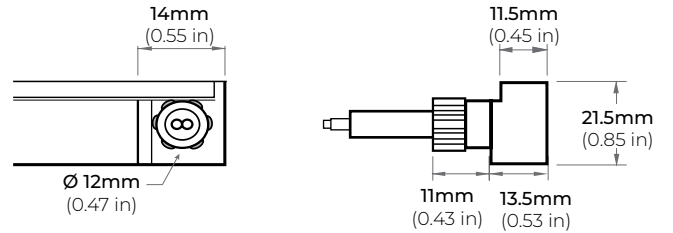
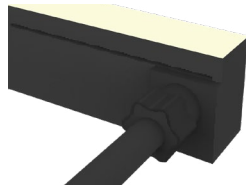

BF
BOTTOM FEED

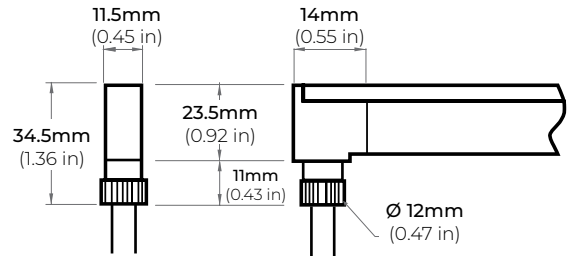

EC
END CAP

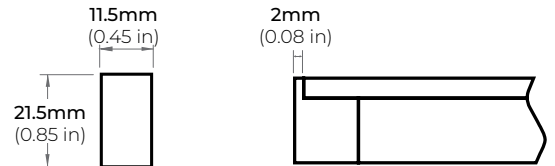
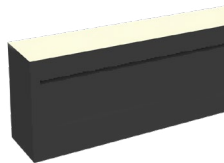

LNT-45 BLACK



3.7W IP67/68 FLEXIBLE LED NEON SERIES

CUTTING LENGTH CODES

LNT-45 Black is cuttable every 2.19" (5.6CM). Please refer to the chart below to determine actual lengths once LED is cut versus actual lengths required or specified.

Total Length Calculation = Order Code Length + End Feed option Length
Example: 33.95" Total Length = Order Code 15 (32.85") + (1.1") End Feed

POWER FEED OPTION	
END FEED	1.1"
BOTTOM FEED	0.20"
SIDE FEED	0.20"

CUTTING LENGTH INCREMENT TABLE

CODE	LENGTH (CM)	LENGTH (IN)
1	5.6	2.19
2	11.2	4.38
3	16.8	6.57
4	22.4	8.76
5	28	10.95
6	33.6	13.14
7	39.2	15.33
8	44.8	17.52
9	50.4	19.71
10	56	21.9
11	61.6	24.09
12	67.2	26.28
13	72.8	28.47
14	78.4	30.66
15	84	32.85
16	89.6	35.04
17	95.2	37.23
18	100.8	39.42
19	106.4	41.61
20	112	43.8
21	117.6	45.99
22	123.2	48.18
23	128.8	50.37
24	134.4	52.56
25	140	54.75
26	145.6	56.94
27	151.2	59.13
28	156.8	61.32
29	162.4	63.51
30	168	65.7
31	173.6	67.89
32	179.2	70.08
33	184.8	72.27
34	190.4	74.46
35	196	76.65
36	201.6	78.84
37	207.2	81.03
38	212.8	83.22
39	218.4	85.41
40	224	87.6

CODE	LENGTH (CM)	LENGTH (IN)
41	229.6	89.79
42	235.2	91.98
43	240.8	94.17
44	246.4	96.36
45	252	98.55
46	257.6	100.74
47	263.2	102.93
48	268.8	105.12
49	274.4	107.31
50	280	109.5
51	285.6	111.69
52	291.2	113.88
53	296.8	116.07
54	302.4	118.26
55	308	120.45
56	313.6	122.64
57	319.2	124.83
58	324.8	127.02
59	330.4	129.21
60	336	131.4
61	341.6	133.59
62	347.2	135.78
63	352.8	137.97
64	358.4	140.16
65	364	142.35
66	369.6	144.54
67	375.2	146.73
68	380.8	148.92
69	386.4	151.11
70	392	153.3
71	397.6	155.49
72	403.2	157.68
73	408.8	159.87
74	414.4	162.06
75	420	164.25
76	425.6	166.44
77	431.2	168.63
78	436.8	170.82
79	442.4	173.01
80	448	175.2

CODE	LENGTH (CM)	LENGTH (IN)
81	453.6	177.39
82	459.2	179.58
83	464.8	181.77
84	470.4	183.96
85	476	186.15
86	481.6	188.34
87	487.2	190.53
88	492.8	192.72
89	498.4	194.91
90	504	197.1
91	509.6	199.29
92	515.2	201.48
93	520.8	203.67
94	526.4	205.86
95	532	208.05
96	537.6	210.24
97	543.2	212.43
98	548.8	214.62
99	554.4	216.81
100	560	219

LNT-45 BLACK

3.7W IP67/68 FLEXIBLE LED NEON SERIES

COMPATIBLE TRANSFORMERS

PSDL SERIES TRIAC DIMMABLE

PSDL-30W-24V	CLASS 2	6.5" X 3.63" X 1.03"
PSDL-60W-24V	CLASS 2	7.4" X 3.63" X 1.03"
PSDL-96W-24V	CLASS 2	8.67" X 3.67" X 1.62"
PSDL-150W-24V		8.67" X 3.67" X 1.62"
PSDL-192W-24V	CLASS 2	10.25" X 4.06" X 1.82"
PSDL-200W-24V		10.25" X 4.06" X 1.82"
PSDL-288W-24V	CLASS 2	10.25" X 4.06" X 1.82"
PSDL-300W-24V		10.25" X 4.06" X 1.82"

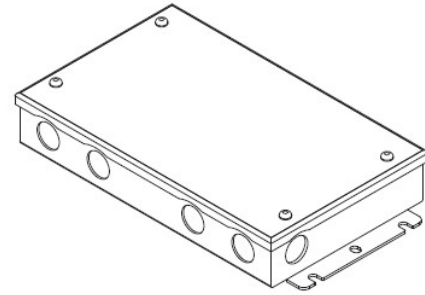

PSDH SERIES HIGH PERFORMANCE MAGNETIC LOW VOLTAGE (MLV)

PSDH-48W-24V	CLASS 2	11.25" X 3.37" X 3.25"
PSDH-96W-24V	CLASS 2	11.25" X 3.37" X 3.25"
PSDH-288W-24V	CLASS 2	14.25" X 8.43" X 4.43"

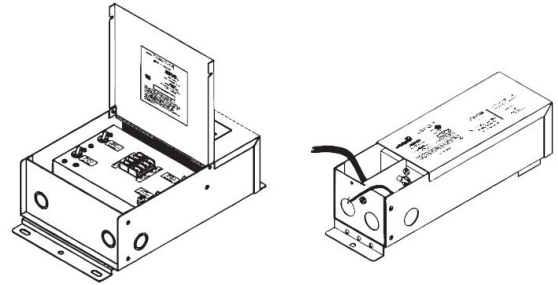

PSRX SERIES 4-IN-1 DIMMING DRIVER

PSRX-30W-24V	CLASS 2	6.5" X 3.72" X 1.57"
PSRX-60W-24V	CLASS 2	7.4" X 3.72" X 1.57"
PSRX-96W-24V	CLASS 2	8.66" X 3.72" X 1.57"
PSRX-150W-24V		10.24" X 4.13" X 1.77"
PSRX-192W-24V	CLASS 2	11" X 4" X 1.82"
PSRX-200W-24V		10.24" X 4.13" X 1.77"
PSRX-288W-24V	CLASS 2	11.85" X 4.25" X 1.82"
PSRX-300W-24V		10.94" X 4.33" X 1.77"

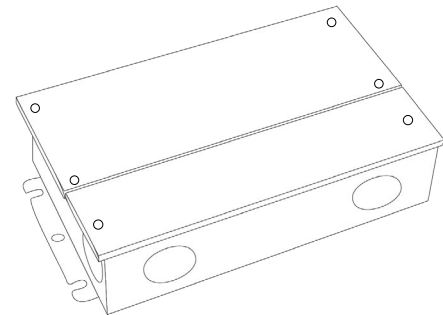

PSVT SERIES 0-10V DIMMING DRIVER

PSVT-60W-24V	CLASS 2	7.4" X 3.72" X 1.57"
PSVT-96W-24V	CLASS 2	8.66" X 3.72" X 1.57"
PSVT-200W-24V		10.24" X 4.13" X 1.77"
PSVT-288W-24V	CLASS 2	11.85" X 4.25" X 1.81"
PSVT-300W-24V		10.94" X 4.33" X 1.77"

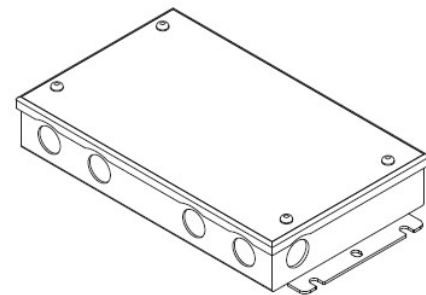

LNT-45 BLACK

3.7W IP67/68 FLEXIBLE LED NEON SERIES

COMPATIBLE TRANSFORMERS

PSDE SERIES

0-10V DIMMING W/ JUNCTION BOX

PSDE-60W-24V-010-JB	CLASS 2	12.1" X 2.36" X 1.4"
PSDE-96W-24-010-JB	CLASS 2	12.1" X 2.36" X 1.4"

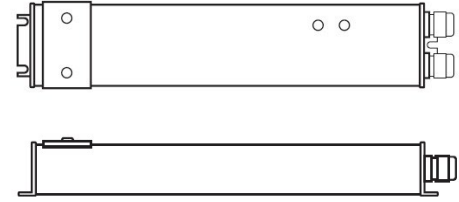

LUTRON 1%

3-WIRE DIMMING

L3DA4U1UKL-CV240	CLASS 2	4.89" X 4" X 2.62"
------------------	---------	--------------------

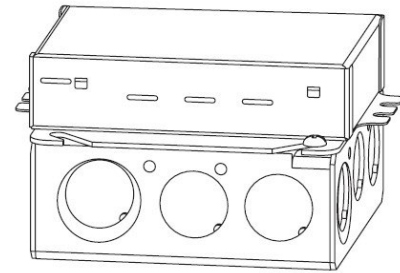

PSDE-96W-24V-ECO	CLASS 2	10.5" X 3.0" X 2.0"
------------------	---------	---------------------

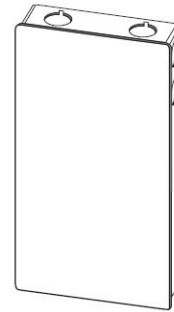

COMPATIBLE NON-DIMMING DRIVERS

PSHK SERIES

NON-DIMMING CONSTANT VOLTAGE WITH JUNCTION BOX

PSHK-30W-24V	CLASS 2	6.5" X 3.6" X 1.02"
PSHK-60W-24V	CLASS 2	7.4" X 3.62" X 1.02"
PSHK-96W-24V	CLASS 2	8.66" X 3.66" X 1.61"
PSHK-150W-24V		10.24" X 4.06" X 1.81"
PSHK-200W-24V		10.24" X 4.06" X 1.81"
PSHK-288W-24V	CLASS 2	11.85" X 4.25" X 1.82"
PSHK-300W-24V		10.24" X 4.25" X 1.81"

