

LNT-20 HB/VB SERIES

1.5W IP65 FLEXIBLE LED NEON SERIES

Project _____

Location _____

Quote/ Ref # _____

The **LNT-20HBVB** is a high performance, flexible LED strip designed as a neon replacement, useful in a wide variety of indoor or outdoor applications where a smooth surface or continuous line of light is desired. It can bend around contours or tight curves horizontally or vertically without being damaged. It allows for easy installation with its factory sealed terminators and self locking male and female barrel connectors. Fully encapsulated UV protected and wet location rated.

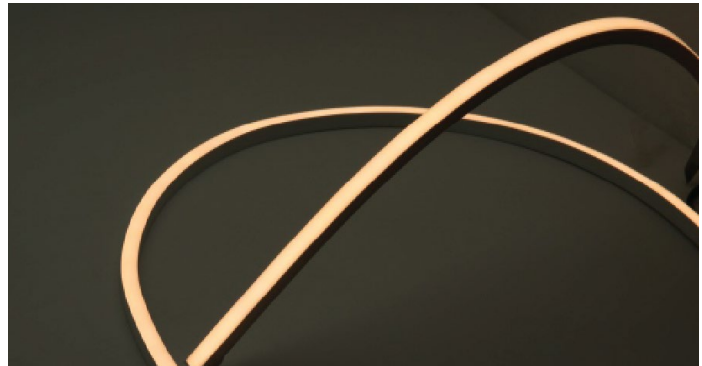

SPECIFICATIONS

INPUT VOLTAGE	24V DC Constant Voltage
POWER CONSUMPTION	1.5W per Ft.
LUMEN OUTPUT	47Lm/ Ft.
CRI	90+
COLOR TEMPERATURE	22K/ 24K/ 27K/ 30K/ 35K/ 40K/ 50K/ RD/ GN/ BL/ AM
DIMMING/ CONTROL	MLV, ELV, 0-10V and TRIAC
MAXIMUM RUN LENGTH	32 Ft.
CUTTABLE	Every 83.3mm (3.28 in)
POWER FACTOR	≤ 1
STORAGE TEMPERATURE	-40°F (-40°C) to 140°F (60°C)
OPERATING TEMPERATURE	-40°F (-40°C) to 131°F (55°C)
BEAM ANGLE	160°
HUMIDITY	0-95% Non Condensing
IP RATING	IP65
CERTIFICATIONS	UL Listed
LUMEN MAINTENANCE	50,000 Hrs.

FEATURES

- High color consistency
- Multiple CCT options available
- Ideal for indoor and outdoor use
- Continuous run length up to 32 Ft.
- Dimmable with CORE dimmable drivers
- UL Listed



MODEL	SURFACE	COLOR TEMP	VOLTAGE	LENGTH	POWER FEED	FEED LENGTH		
LNT-20	HB Horizontal Bend	22K 2200K	RD* Red	24 24V DC	Please refer to page 4 for exact lengths with corresponding ordering codes.	IP65BF Bottom Feed	HW3 3' Power Feed	
		24K 2400K	GN* Green				HW10 10' Power Feed	
		27K 2700K	BL* Blue				HW16 16' Power Feed	
	VB Vertical Bend	30K 3000K	AM* Amber				IP65SFL Side Feed Left	HW32 32' Power Feed
		35K 3500K					IP65SFR Side Feed Right	HW50 50' Power Feed
		40K 4000K					IP65EF End Feed	
		50K 5000K						

LNT-20 HB/VB SERIES

1.5W IP65 FLEXIBLE LED NEON SERIES

DIMENSIONS

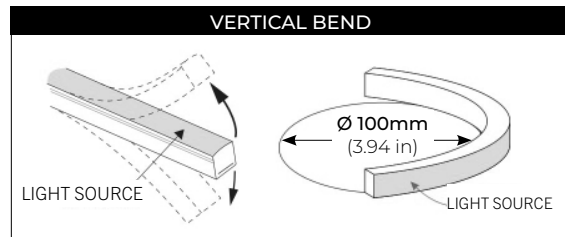
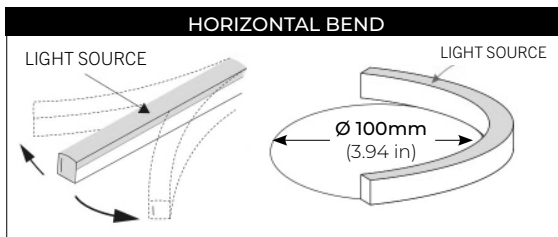
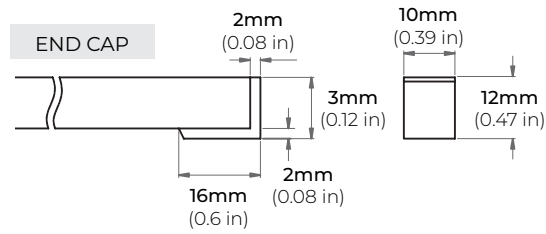
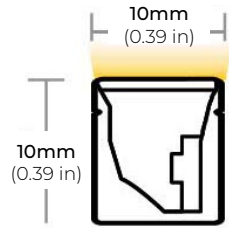

MOUNTING ACCESSORIES

ALUMINUM PROFILE

LNT20-AC2
2" PROFILE

LNT20-AC39
39" PROFILE

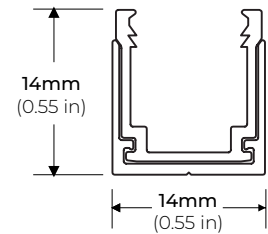

FLEXIBLE ALUMINUM PROFILE

LNT20-AFX
39" PROFILE

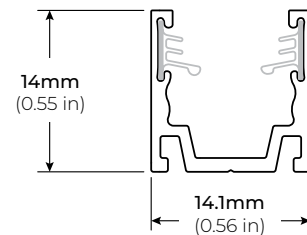
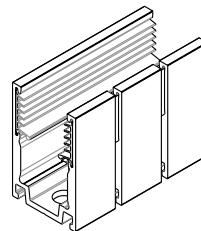

LNT-20 HB/VB SERIES

1.5W IP65 FLEXIBLE LED NEON SERIES

IP65 POWER FEED

IP65EF
END FEED

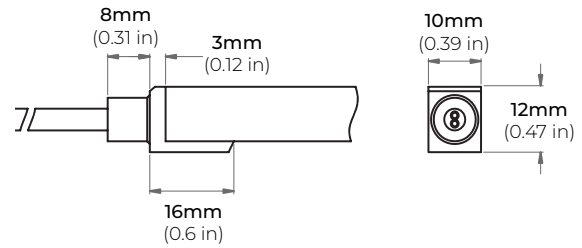

IP65SFL
SIDE FEED LEFT

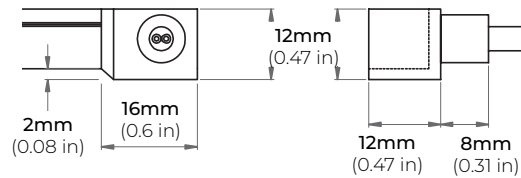

IP65SFR
SIDE FEED RIGHT

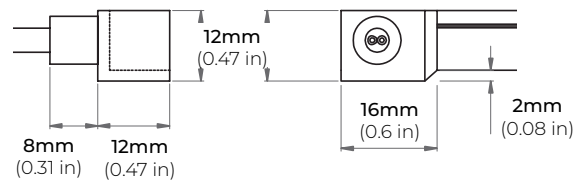

IP65BF
BOTTOM FEED

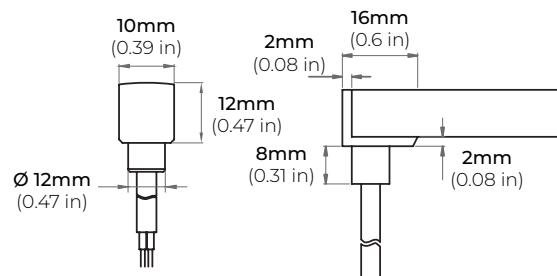

LNT-20 HB/VB SERIES

1.5W IP65 FLEXIBLE LED NEON SERIES

CUTTING LENGTH CODES

LNT-20 is **FACTORY CUT ONLY** every 3.28" (8.33CM). Please refer to the chart below to determine actual lengths once LED is cut versus actual lengths required or specified.

Total Length Calculation = Order Code Length + End Feed option Length
Example: 49.8" Total Length = Order Code 15 (49.2) + (0.60") IP65 Side Feed

POWER FEED OPTION	IP65
END FEED	0.91"
BOTTOM FEED	0.60"
SIDE FEED	0.60"

CUTTING LENGTH INCREMENT TABLE

CODE	LENGTH (CM)	LENGTH (IN)
1	8.33	3.28
2	16.66	6.56
3	24.99	9.84
4	33.32	13.12
5	41.65	16.4
6	49.98	19.68
7	58.31	22.96
8	66.64	26.24
9	74.97	29.52
10	83.3	32.8
11	91.63	36.08
12	99.96	39.36
13	108.29	42.64
14	116.62	45.92
15	124.95	49.2
16	133.28	52.48
17	141.61	55.76
18	149.94	59.04
19	158.27	62.32
20	166.6	65.6
21	174.93	68.88
22	183.26	72.16
23	191.59	75.44
24	199.92	78.72
25	208.25	82
26	216.58	85.28
27	224.91	88.56
28	233.24	91.84
29	241.57	95.12
30	249.9	98.4
31	258.23	101.68
32	266.56	104.96
33	274.89	108.24
34	283.22	111.52
35	291.55	114.8
36	299.88	118.08
37	308.21	121.36
38	316.54	124.64
39	324.87	127.92
40	333.2	131.2

CODE	LENGTH (CM)	LENGTH (IN)
41	341.53	134.48
42	349.86	137.76
43	358.19	141.04
44	366.52	144.32
45	374.85	147.6
46	383.18	150.88
47	391.51	154.16
48	399.84	157.44
49	408.17	160.72
50	416.5	164
51	424.83	167.28
52	433.16	170.56
53	441.49	173.84
54	449.82	177.12
55	458.15	180.4
56	466.48	183.68
57	474.81	186.96
58	483.14	190.24
59	491.47	193.52
60	499.8	196.8
61	508.13	200.08
62	516.46	203.36
63	524.79	206.64
64	533.12	209.92
65	541.45	213.2
66	549.78	216.48
67	558.11	219.76
68	566.44	223.04
69	574.77	226.32
70	583.1	229.6
71	591.43	232.88
72	599.76	236.16
73	608.09	239.44
74	616.42	242.72
75	624.75	246
76	633.08	249.28
77	641.41	252.56
78	649.74	255.84
79	658.07	259.12
80	666.4	262.4

CODE	LENGTH (CM)	LENGTH (IN)
81	674.73	265.68
82	683.06	268.96
83	691.39	272.24
84	699.72	275.52
85	708.05	278.8
86	716.38	282.08
87	724.71	285.36
88	733.04	288.64
89	741.37	291.92
90	749.7	295.2
91	758.03	298.48
92	766.36	301.76
93	774.69	305.04
94	783.02	308.32
95	791.35	311.6
96	799.68	314.88
97	808.01	318.16
98	816.34	321.44
99	824.67	324.72
100	833	328
101	841.33	331.28
102	849.66	334.56
103	857.99	337.84
104	866.32	341.12
105	874.65	344.4
106	882.98	347.68
107	891.31	350.96
108	899.64	354.24
109	907.97	357.52
110	916.3	360.8
111	924.63	364.08
112	932.96	367.36
113	941.29	370.64
114	949.62	373.92
115	957.95	377.2
116	966.28	380.48
117	974.61	383.76

LNT-20 HB/VB SERIES

1.5W IP65 FLEXIBLE LED NEON SERIES

COMPATIBLE TRANSFORMERS

PSDL SERIES TRIAC DIMMABLE

PSDL-30W-24V	CLASS 2	6.5" X 3.63" X 1.58"
PSDL-60W-24V	CLASS 2	7.4" X 3.63" X 1.58"
PSDL-96W-24V	CLASS 2	8.67" X 3.67 X 1.62"
PSDL-150W-24V		10.25" X 4.06" X 1.82"
PSDL-192W-24V	CLASS 2	11" X 4" X 1.82"
PSDL-200W-24V		10.25" X 4.06" X 1.82"
PSDL-288W-24V	CLASS 2	11.85" X 4.25" X 1.82"
PSDL-300W-24V		10.25" X 4.06" X 1.82"

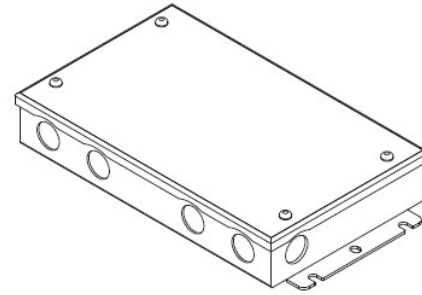

PSDH SERIES HIGH PERFORMANCE MAGNETIC LOW VOLTAGE (MLV)

PSDH-48W-24V	CLASS 2	11.25" X 3.38" X 3.38"
PSDH-96W-24V	CLASS 2	11.25" X 3.38" X 3.37"
PSDH-288W-24V	CLASS 2	14.25" X 8.43" X 4.43"

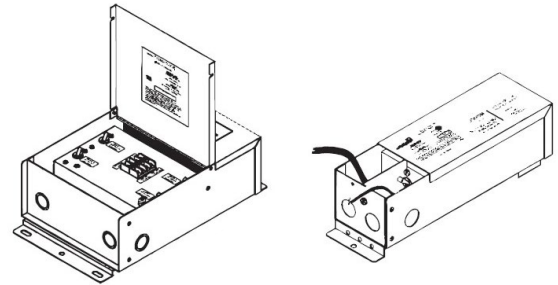

PSRX SERIES 4-IN-1 DIMMING DRIVER

PSRX-30W-24V	CLASS 2	6.5" X 3.72" X 1.57"
PSRX-60W-24V	CLASS 2	7.4" X 3.72" X 1.57"
PSRX-96W-24V	CLASS 2	8.66" X 3.72" X 1.57"
PSRX-150W-24V		10.24" X 4.13" X 1.77"
PSRX-192W-24V	CLASS 2	11" X 4" X 1.82"
PSRX-200W-24V		10.24" X 4.13" X 1.77"
PSRX-288W-24V	CLASS 2	11.85" X 4.25" X 1.82"
PSRX-300W-24V		10.94" X 4.33" X 1.77"

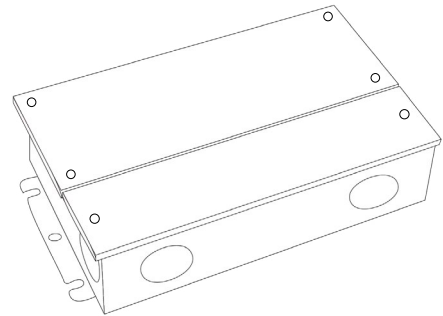

PSVT SERIES 0-10V DIMMING WITH JUNCTION BOX

PSVT-60W-24V-UNV-010	CLASS 2	7.4" X 3.72" X 1.57"
PSVT-96W-24V-UNV-010	CLASS 2	8.66" X 3.72" X 1.57"
PSVT-200W-24V-UNV-010		10.24" X 4.13" X 1.77"
PSVT-288W-24V-UNV-010	CLASS 2	11.85" X 4.25" X 1.81"
PSVT-300W-24V-UNV-010		10.94" X 4.33" X 1.77"

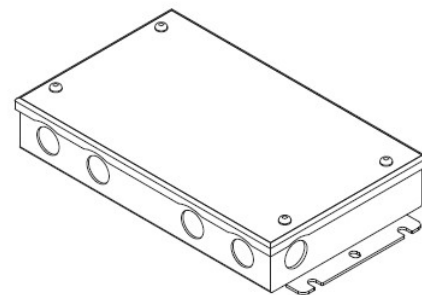

LNT-20 HB/VB SERIES

1.5W IP65 FLEXIBLE LED NEON SERIES

COMPATIBLE TRANSFORMERS

PSDE SERIES

0-10V DIMMING W/ JUNCTION BOX

PSDE-60W-24V-010-JB	CLASS 2	12.1" X 2.36" X 1.4"
PSDE-96W-24V-010-JB	CLASS 2	12.1" X 2.36" X 1.4"

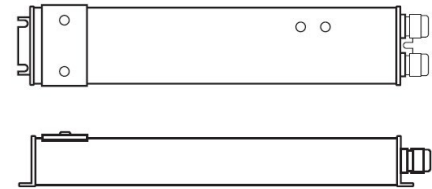

LUTRON 1%

3-WIRE DIMMING

L3DA4U1UKL-CV240	CLASS 2	4.89" X 4" X 2.62"
------------------	---------	--------------------

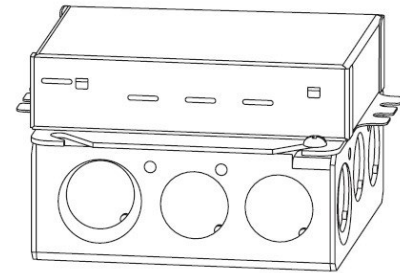

PSDE-96W-24V-ECO	CLASS 2	10.5" X 3.0" X 2.0"
------------------	---------	---------------------

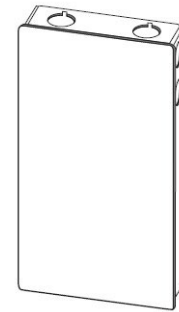

COMPATIBLE NON-DIMMING DRIVERS

PSHK SERIES

NON-DIMMING CONSTANT VOLTAGE WITH JUNCTION BOX

PSHK-30W-24V	CLASS 2	6.5" X 3.6" X 1.02"
PSHK-60W-24V	CLASS 2	7.4" X 3.62" X 1.02"
PSHK-96W-24V	CLASS 2	8.66" X 3.66" X 1.61"
PSHK-150W-24V		10.24" X 4.06" X 1.81"
PSHK-200W-24V		10.24" X 4.06" X 1.81"
PSHK-288W-24V	CLASS 2	11.85" X 4.25" X 1.82"
PSHK-300W-24V		10.24" X 4.25" X 1.81"

