

# LNT-65 RGB

## 3.4W IP67/68 COLOR CHANGING LED NEON SERIES

Project \_\_\_\_\_  
Location \_\_\_\_\_  
Quote/ Ref # \_\_\_\_\_

**LNT-65 RGB** is a high performance flexible LED fixture designed as a neon replacement. Suitable for indoor and outdoor applications, the LNT-65 RGB can bend around contours or tight radiuses without being damaged. It allows for easy installation with its factory sealed terminators and self-locking male and female barrel connectors.

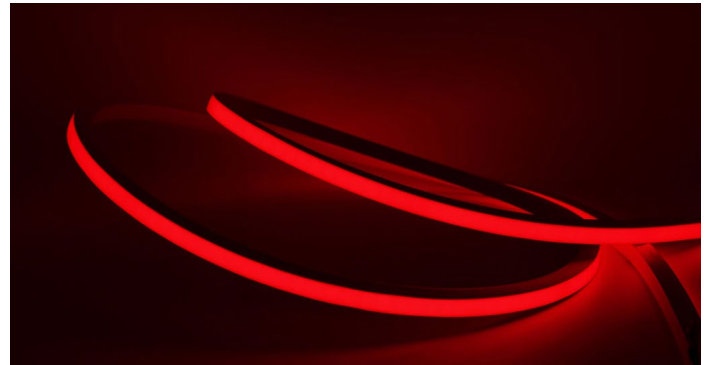

### SPECIFICATIONS

INPUT VOLTAGE	24V DC Constant Voltage
POWER CONSUMPTION	3.4W per Ft.
LUMEN OUTPUT	190 Lm/ Ft.
LED CHIP	NICHIA
CRI	88+
COLOR TEMPERATURE	RGB
DIMMING	Through RGB controller
MAXIMUM RUN LENGTH	32 Ft.
CUTTABLE	Every 55.6mm (2.19 in)
STORAGE TEMPERATURE	-40°F (-40°C) to 176°F (80°C)
OPERATING TEMPERATURE	-4°F (-20°C) to 113°F (45°C)
BEAM ANGLE	160°
HUMIDITY	0-95% Non Condensing
IP RATING	IP67/ IP68
CERTIFICATIONS	UL Listed, UL-676 (IP68)
LUMEN MAINTENANCE	50,000 Hrs.

### FEATURES

- High color consistency and smooth illumination
- Multiple CCT options available
- Bottom, Side and End Feed options
- UL-676 Pool Submersible (IP68 model)
- Waterproof/ Underwater Submersible



MODEL	LENS	SURFACE	COLOR TEMP	VOLT	LENGTH	POWER FEED	FEED LENGTH
LNT-65	F Flat	HB Horizontal Bend	RGB RGB Color Changing	24 24V DC	Please refer to page 4-5 for exact lengths with corresponding ordering codes.	BF Bottom Feed	HW3 3 Ft. Power Feed
		VB Vertical Bend				SFL Side Feed Left	HW10 10 Ft. Power Feed
		SFR Side Feed Right				HW15 15 Ft. Power Feed	
		EF End Feed				HW30 30 Ft. Power Feed	
		HW50 50 Ft. Power Feed					

# LNT-65 RGB

## 3.4W IP67/68 COLOR CHANGING LED NEON SERIES

### DIMENSIONS

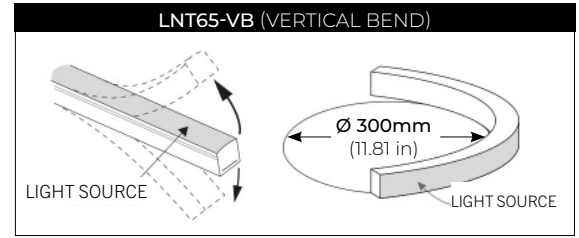
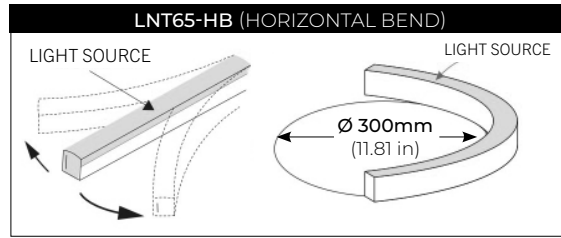
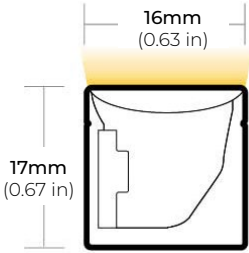

### COMPATIBLE ACCESSORIES

#### SELF LOCKING ALUMINUM PROFILE

LNT65-AC2  
2" PROFILE

LNT65-AC39  
39" PROFILE

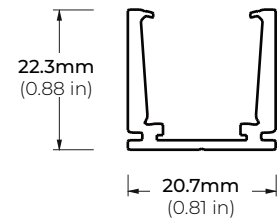
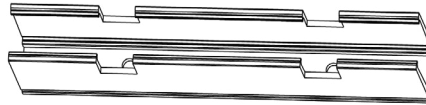

#### PLASTIC PROFILE

LNT65-PC39  
39" PROFILE

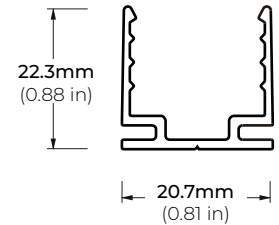
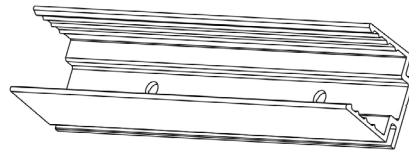

#### RECESSED PROFILE

LNT65-RS39  
39" PROFILE

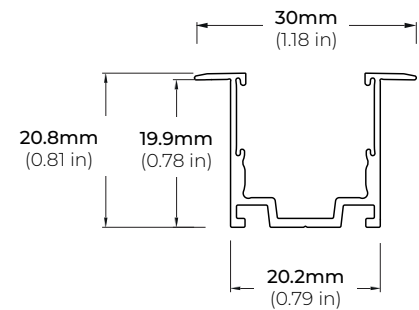
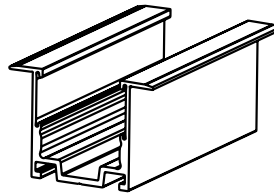

#### FLEXIBLE PROFILE

LNT65-SPX39-WH  
39" PROFILE (WHITE)

LNT65-SPX39-BK  
39" PROFILE (BLACK)

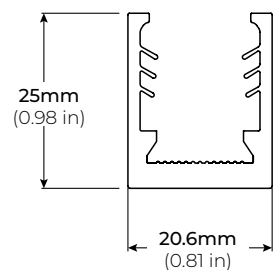
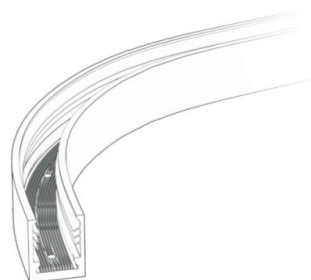

# LNT-65 RGB

## 3.4W IP67/68 COLOR CHANGING LED NEON SERIES

### COMPATIBLE ACCESSORIES

LNT65-BKT-ADJ  
ADJUSTABLE BRACKET

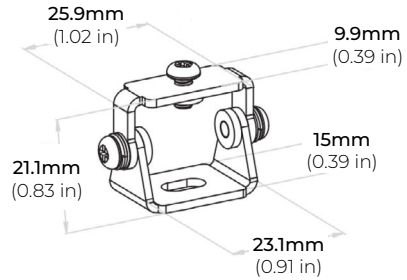

### POWER FEED

BF  
BOTTOM FEED

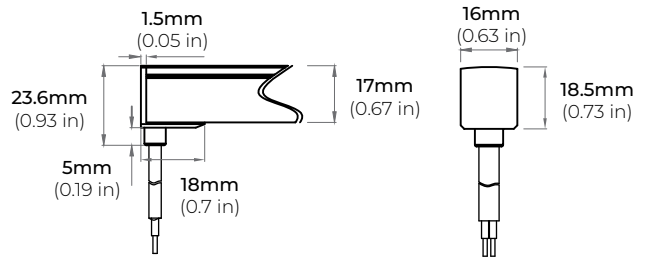

SFL  
SIDE FEED LEFT

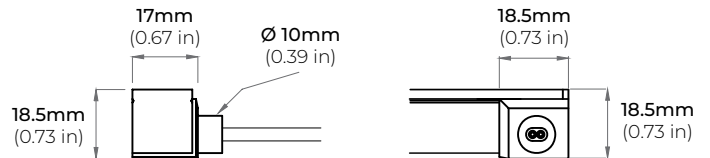

SFR  
SIDE FEED RIGHT

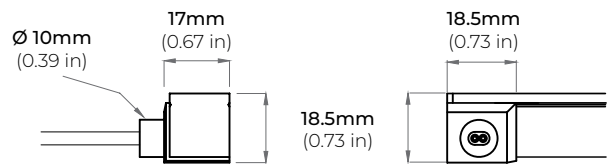
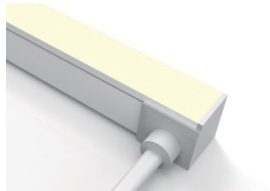

EF  
END FEED

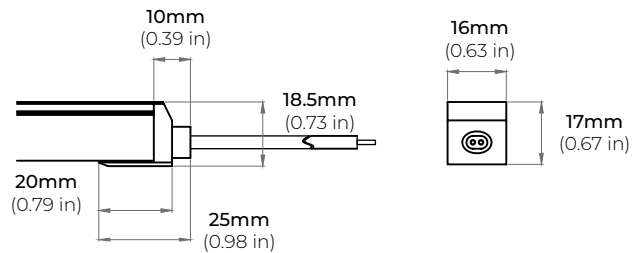

LNT65-EC  
END CAP

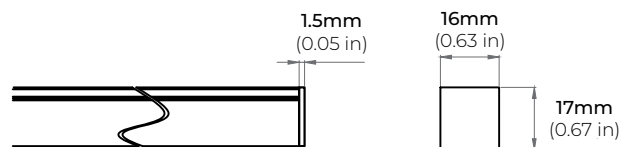
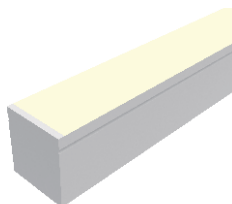

# LNT-65 RGB

## 3.4W IP67/68 COLOR CHANGING LED NEON SERIES

### CUTTING LENGTH CODES

LNT-65 RGB Series is cuttable every 2.19" (5.56CM). Please refer to the chart below to determine actual lengths once LED is cut versus actual lengths required or specified.

Total Length Calculation = Order Code Length + End Feed option Length  
**Example: 65.9" Total Length = Order Code 30 (65.7") + (0.20") Side Feed**

\* Optional lead wire lengths available: 3Ft., 10Ft., 16Ft., 32Ft., 50Ft.

POWER FEED OPTION	
END FEED	1.1"
BOTTOM FEED	0.20"
SIDE FEED	0.20"

### CUTTING LENGTH INCREMENT TABLE

CODE	LENGTH (CM)	LENGTH (IN)
3	16.68	6.57
4	22.24	8.76
5	27.8	10.95
6	33.36	13.14
7	38.92	15.33
8	44.48	17.52
9	50.04	19.71
10	55.6	21.90
11	61.16	24.09
12	66.72	26.28
13	72.28	28.47
14	77.84	30.66
15	83.4	32.85
16	88.96	35.04
17	94.52	37.23
18	100.08	39.42
19	105.64	41.61
20	111.2	43.80
21	116.76	45.99
22	122.32	48.18
23	127.88	50.37
24	133.44	52.56
25	139	54.75
26	144.56	56.94
27	150.12	59.13
28	155.68	61.32
29	161.24	63.51
30	166.8	65.70
31	172.36	67.89
32	177.92	70.08
33	183.48	72.27
34	189.04	74.46
35	194.6	76.65
36	200.16	78.84
37	205.72	81.03
38	211.28	83.22
39	216.84	85.41
40	222.4	87.60
41	227.96	89.79
42	233.52	91.94

CODE	LENGTH (CM)	LENGTH (IN)
43	239.08	94.17
44	244.64	96.36
45	250.2	98.55
46	255.76	100.74
47	261.32	102.93
48	266.88	105.12
49	272.44	107.31
50	278	109.50
51	283.56	111.69
52	289.12	113.88
53	294.68	116.07
54	300.24	118.26
55	305.8	120.45
56	311.36	122.64
57	316.92	124.83
58	322.48	127.02
59	328.04	129.21
60	333.6	131.40
61	339.16	133.59
62	344.72	135.78
63	350.28	137.97
64	355.84	140.16
65	361.4	142.35
66	366.96	144.54
67	372.52	146.73
68	378.08	148.92
69	383.64	151.11
70	389.2	153.30
71	394.76	155.49
72	400.32	157.68
73	405.88	159.87
74	411.44	162.06
75	417	164.25
76	422.56	166.44
77	428.12	168.63
78	433.68	170.82
79	439.24	173.01
80	444.8	175.20
81	450.36	177.39
82	455.92	179.58

CODE	LENGTH (CM)	LENGTH (IN)
83	461.48	181.77
84	467.04	183.96
85	472.6	186.15
86	478.16	188.34
87	483.72	190.53
88	489.28	192.72
89	494.84	194.91
90	500.4	197.10
91	505.96	199.29
92	511.52	201.48
93	517.08	203.67
94	522.64	205.86
95	528.2	208.05
96	533.76	210.24
97	539.32	212.43
98	544.88	214.62
99	550.44	216.81
100	556	219.00
101	561.56	221.19
102	567.12	223.38
103	572.68	225.57
104	578.24	227.76
105	583.8	229.95
106	589.36	232.14
107	594.92	234.33
108	600.48	236.52
109	606.04	238.71
110	611.6	240.90
111	617.16	243.09
112	622.72	245.28
113	628.28	247.47
114	633.84	249.66
115	639.4	251.85
116	644.96	254.04
117	650.52	256.23
118	656.08	258.42
119	661.64	260.61
120	667.2	262.80
121	672.76	264.99
122	678.32	267.18

# LNT-65 RGB

## 3.4W IP67/68 COLOR CHANGING LED NEON SERIES

### CUTTING LENGTH CODES (CONT.)

LNT-65 RGB is cuttable every 2.19" (5.56CM). Please refer to the chart below to determine actual lengths once LED is cut versus actual lengths required or specified.

Total Length Calculation = Order Code Length + End Feed option Length

**Example: 65.9" Total Length = Order Code 30 (65.7") + (0.20") Side Feed**

\* Optional lead wire lengths available: 3Ft., 10Ft., 16Ft., 32Ft., 50Ft.

POWER FEED OPTION	
END FEED	1.1"
BOTTOM FEED	0.20"
SIDE FEED	0.20"

### CUTTING LENGTH INCREMENT TABLE

CODE	LENGTH (CM)	LENGTH (IN)
123	683.88	269.37
124	689.44	271.56
125	695	273.75
126	700.56	275.94
127	706.12	278.13
128	711.68	280.32
129	717.24	282.51
130	722.8	284.70
131	728.36	286.89
132	733.92	289.08
133	739.48	291.27
134	745.04	293.46
135	750.6	295.65
136	756.16	297.84
137	761.72	300.03
138	767.28	302.22
139	772.84	304.41
140	778.4	306.60
141	783.96	308.79
142	789.52	310.98
143	795.08	313.17
144	800.64	315.36
145	806.2	317.55
146	811.76	319.74
147	817.32	321.93
148	822.88	324.12
149	828.44	326.31
150	834	328.50
151	839.56	330.69
152	845.12	332.88
153	850.68	335.07
154	856.24	337.26
155	861.8	339.45
156	867.36	341.64
157	872.92	343.83
158	878.48	346.02
159	884.04	348.21
160	889.6	350.40
161	895.16	352.59
162	900.72	354.78

CODE	LENGTH (CM)	LENGTH (IN)
163	906.28	356.97
164	911.84	359.16
165	917.4	361.35
166	922.96	363.54
167	928.52	365.73
168	934.08	367.92
169	939.64	370.11
170	945.2	372.30
171	950.76	374.49
172	956.32	376.68
173	961.88	378.87
174	967.44	381.06
175	973	383.25
176	978.56	385.44
177	984.12	387.63
178	989.68	389.82
179	995.24	392.01
180	1000.8	394.20

# LNT-65 RGB

## 3.4W IP67/68 COLOR CHANGING LED NEON SERIES

### NON-DIMMING DRIVERS (COMPATIBLE WITH ALL SYSTEMS)

#### PSHK SERIES

NON-DIMMING CONSTANT VOLTAGE WITH JUNCTION BOX

PSHK-30W-24V	CLASS 2	6.5" X 3.6" X 1.02"
PSHK-60W-24V	CLASS 2	7.4" X 3.62" X 1.02"
PSHK-96W-24V	CLASS 2	8.66" X 3.66" X 1.61"
PSHK-150W-24V		10.24" X 4.06" X 1.81"
PSHK-200W-24V		10.24" X 4.06" X 1.81"
PSHK-288W-24V	CLASS 2	11.85" X 4.25" X 1.82"
PSHK-300W-24V		10.24" X 4.25" X 1.81"

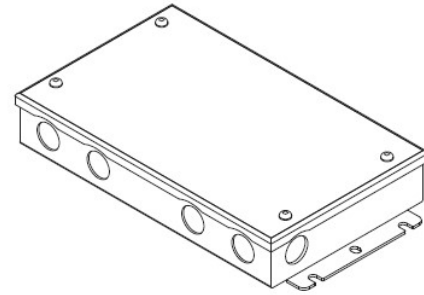

# LNT-65 RGB

## 3.4W IP67/68 COLOR CHANGING LED NEON SERIES

### NON-DMX CONTROLLERS (CONTINUED)

#### RGB-CT840 BLUETOOTH TOUCH PANEL WALL CONTROLLER

INPUT VOLTAGE	12-24V DC
ZONES	4
CONTROL MODE	RGB   RGBW
WIRELESS PROTOCOL	Bluetooth 5.0 SIG Mesh
WORKING TEMP	-20°C ~ 55°C
DIMENSIONS	LxWxH (4.7"x3"x1.2")

*\* Paired with RGB-CT800-RC (Sold Separately)*



#### RGB-CT800-RC BLUETOOTH CONSTANT VOLTAGE LED RECEIVER

INPUT VOLTAGE	12V   24V
OUTPUT CURRENT	4Ax5CH / 5Ax4CH (20A Max)
POWER CAPACITY	240W (12V)   480W (24V)
PROGRAMMABILITY	iOS and Android
WORKING TEMP	-20°C ~ 55°C
DIMENSIONS	LxWxH (6.9 x1.7 x 1.2")

*\* Paired with RGB-CT840 (Sold Separately)*



# LNT-65 RGB

## 3.4W IP67/68 COLOR CHANGING LED NEON SERIES

### NON-DMX CONTROLLERS

#### RGB-CT550

RGBW WIRELESS RECEIVER / CONTROLLER SYSTEM

REMOTE DISTANCE	100 Ft. (Line of Sight)
FREQUENCY	2.4 GHz
DIMENSIONS	LxWxH (6.38"x1.65"x0.59")
WEIGHT	0.44lbs.

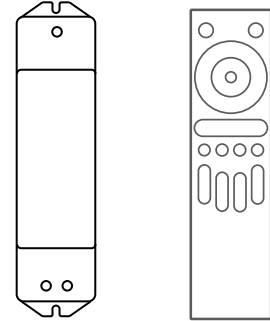

\* RGB-CT500-RX  
(Sold Separately)

#### RGB-CT550-RX

RGBW WIRELESS RECEIVER / CONTROLLER SYSTEM

INPUT VOLTAGE	DC5V ~ DC24V
POWER CAPACITY	100W (5V)   240W (12V)   480W (24V)
OUTPUT CURRENT	5A per Channel (20A Total)
WORKING TEMP	-30°C~55°C (-22°F~131°F)
DIMENSIONS	LxWxH (6.89"x1.73"x1.18")

\* RGB-CT500-RX (Sold Separately)

#### RGB-CT700

MASTER RGBW WIFI CONTROLLER

INPUT VOLTAGE	12-24V DC
OUTPUT TYPE	Constant Voltage
POWER CAPACITY	288W (12V)   384W (24V)
OUTPUT CURRENT	5A per Channel (20A Total)
WORKING TEMP	-4°F (-20°C) ~ 122°F (50°C)
DIMENSIONS	LxWxH (7 x1.8 x 0.8")

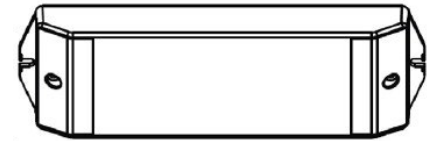

\* Paired with RGB-CT705ZR (Sold Separately)

#### RGB-CT705ZR

SLAVE RGBW WIFI CONTROLLER

INPUT VOLTAGE	12-24V DC
OUTPUT TYPE	Constant Voltage
POWER CAPACITY	288W (12V)   384W (24V)
OUTPUT CURRENT	5A per Channel (20A Total)
WORKING TEMP	-4°F (-20°C) ~ 122°F (50°C)
DIMENSIONS	LxWxH (7 x0,63 x 0.71")

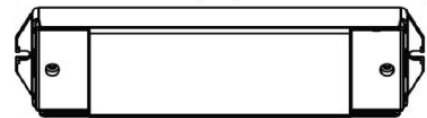

\* Paired with RGB-CT700 (Sold Separately)



# LNT-65 RGB

## 3.4W IP67/68 COLOR CHANGING LED NEON SERIES

### DMX DECODERS

---

#### RGB-DMX-4C-RJ45 4-CHANNEL DMX DECODER

INPUT VOLTAGE 12V-24V DC  
OUTPUT CURRENT 5A X 4CH  
OUTPUT WATTAGE 60W(12V), 120W(24V)  
OUTPUT CHANNELS 4  
DIMENSIONS LxWxH (7"x1.77"x0.75")

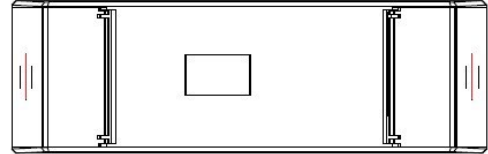

---

#### RGB-DMX-5C-XLR 5-CHANNEL DMX DECODER

INPUT VOLTAGE 12V-24V DC  
OUTPUT CURRENT 8A X 5CH  
OUTPUT WATTAGE 5 x (96W ~ 192W)  
OUTPUT CHANNELS 5  
DIMENSIONS LxWxH (6.45"x2.87"x1.5")

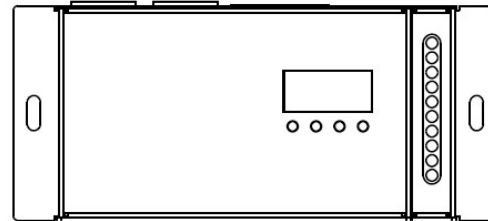

# LNT-65 RGB

## 3.4W IP67/68 COLOR CHANGING LED NEON SERIES

### DMX CONTROLLERS

**RGB CT600**  
MULTI-FUNCTION RGBW WALL CONTROLLER

**INPUT VOLTAGE** 5V DC, 1A  
**OUTPUT SIGNAL** RF 2.4GHZ + DMX512  
**CONTROL** 4 ZONES  
**COLOR OPTIONS** Black/ White  
**WORKING TEMP** -20°C ~ 40°C  
**DIMENSIONS** LxWxH (5.19"x7.08"x1.38")

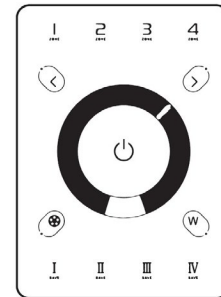

**RGB-SCW4**  
WiFi DMX WALL CONTROLLER

**INPUT VOLTAGE** 5 - 10V DC, 06A  
**OUTPUT SIGNAL** DMX512 (x2)  
**PROGRAMMABILITY** PC/ MAC  
**COLOR OPTIONS** Black/ White  
**CONNECTIONS** USB/ 8dry contact ports/ Open drain output (for relay)  
**MEMORY** Built-In Flash  
**WORKING TEMP** -10°C ~ 45°C  
**DIMENSIONS** LxWxH (5.75"x4.17"x0.43")

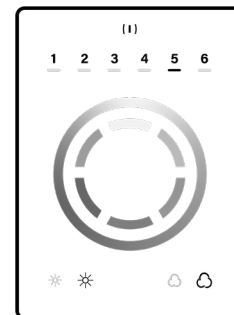

**RGB-SDE3**  
WiFi DMX WALL CONTROLLER

**INPUT VOLTAGE** 6V DC, 0.6A  
**OUTPUT SIGNAL** DMX512 (x2)  
**PROGRAMMABILITY** PC/ MAC/ Tablet/ Smartphone  
**COLOR OPTIONS** Black/ White  
**CONNECTIONS** USB/ Ethernet/ RS232/ CLock/ 8dry contact ports/ 5V output relay  
**MEMORY** MicroSD Card  
**WORKING TEMP** -20°C ~ 40°C  
**DIMENSIONS** LxWxH (5.75"x4.17"x0.43")

