

CURTAIN LED

RETICULAR LED SYSTEM

Project _____

Location _____

Quote/ Ref # _____

The **Curtain LED** is a low voltage, versatile lighting solution featuring multiple rows of LED bars that produce uniform and seamless illumination. Customizable and easy to install, this LED panel system is available in multiple CCT options and is ideal for applications that require both functionality and style.



SPECIFICATIONS

INPUT VOLTAGE	24V DC
POWER CONSUMPTION	1.34W per Bar 86W per Panel
LUMEN OUTPUT	130 Lm. per Bar 8320 Lm. per Panel
NO. OF LEDS	24 LEDs per Bar
BAR COUNT	64 Bars per Panel
CRI	95+
COLOR TEMPERATURE	27K/ 30K/ 35K/ 40K/ 50K
MAXIMUM SIZE	24 x 96 in.
DIMMING	MLV, ELV, 0-10V and TRIAC
CUTTABLE	Cuttable every 0.60"
IP RATING	IP20 (Indoor)
OPERATING TEMPERATURE	-13°F (-25°C) to 140°F (60°C)
WORKING TEMPERATURE	95°F (35°C)
SURFACE TEMPERATURE	LED: 104°F (40°C) PCB: 90°F (32°C)
WEIGHT	3.75 lbs per Array
LUMEN MAINTENANCE	50,000 Hrs.
CERTIFICATIONS	UL Listed, CE, RoHS

FEATURES

- 24 x 96" Panel
- 95+ CRI
- 86W per Panel
- Quick and easy installation
- Multiple CCT Options
- 24V DC



MODEL	COLOR TEMP	COLOR TEMPERATURE	VOLTAGE
CRS	2496 24 x 96 in.	27K 2700K	24 24V DC
		30K 3000K	
		35K 3500K	
		40K 4000K	
		50K 5000K	

CURTAIN LED

RETICULAR LED SYSTEM

DIMENSIONS

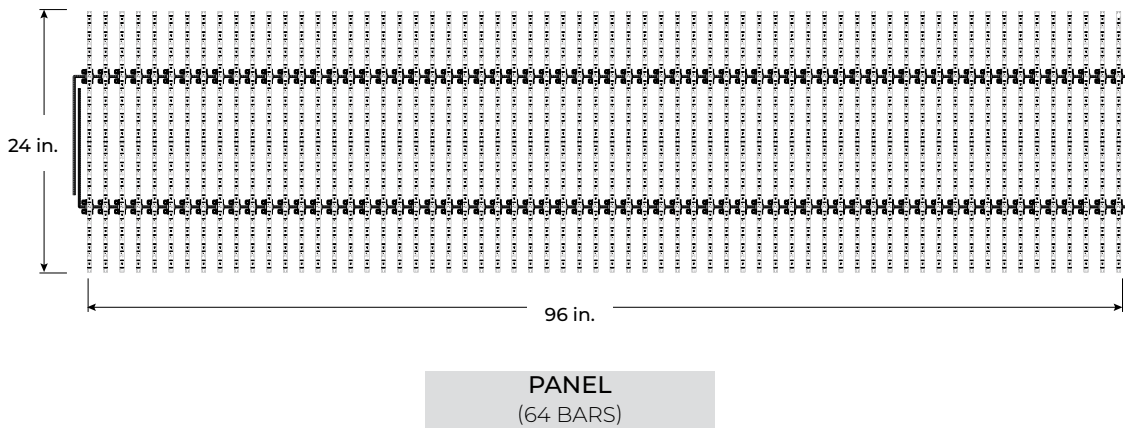
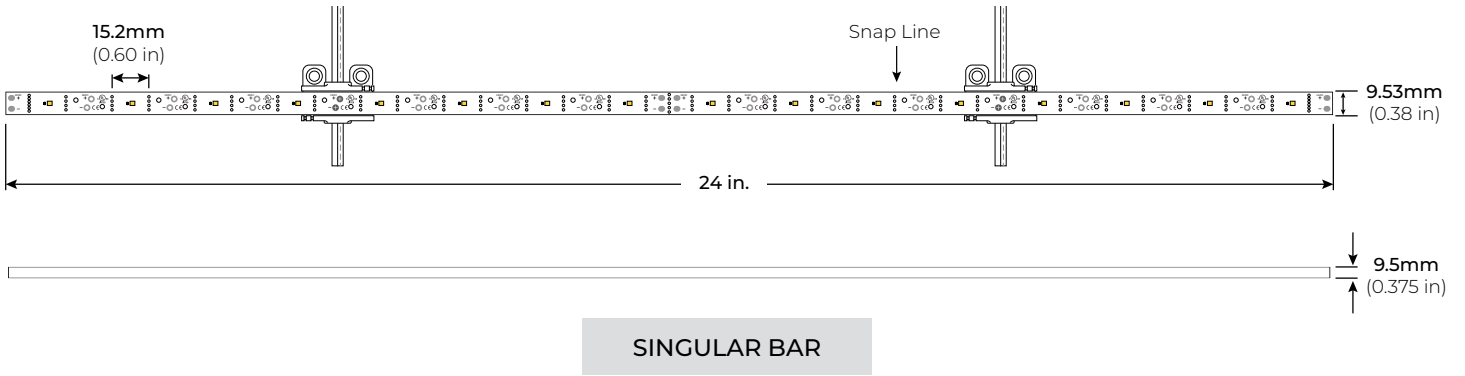

CURTAIN LED

RETICULAR LED SYSTEM

COMPATIBLE TRANSFORMERS

PSDL SERIES TRIAC DIMMABLE

PSDL-30W-24V	CLASS 2	6.5" X 3.63" X 1.03"
PSDL-60W-24V	CLASS 2	7.4" X 3.63" X 1.03"
PSDL-96W-24V	CLASS 2	8.67" X 3.67 X 1.62"
PSDL-150W-24V		8.67" X 3.67" X 1.62"
PSDL-192W-24V	CLASS 2	10.25" X 4.06" X 1.82"
PSDL-200W-24V		10.25" X 4.06" X 1.82"
PSDL-288W-24V	CLASS 2	10.25" X 4.06" X 1.82"
PSDL-300W-24V		10.25" X 4.06" X 1.82"

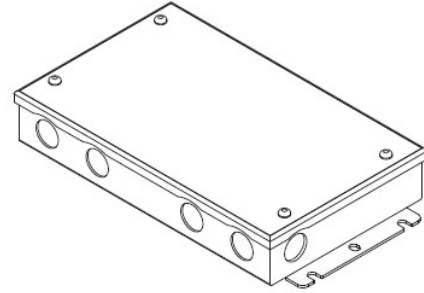

PSDH SERIES HIGH PERFORMANCE MAGNETIC LOW VOLTAGE (MLV)

PSDH-48W-24V	CLASS 2	11.25" X 3.37" X 3.25"
PSDH-96W-24V	CLASS 2	11.25" X 3.37" X 3.25"
PSDH-288W-24V	CLASS 2	14.25" X 8.43" X 4.43"

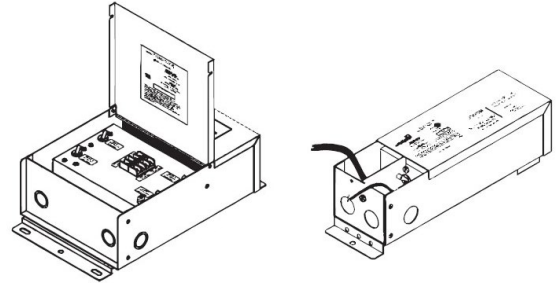

PSRX SERIES 4-IN-1 DIMMING DRIVER

PSRX-30W-24V	CLASS 2	6.5" X 3.72" X 1.57"
PSRX-60W-24V	CLASS 2	7.4" X 3.72" X 1.57"
PSRX-96W-24V	CLASS 2	8.66" X 3.72" X 1.57"
PSRX-150W-24V		10.24" X 4.13" X 1.77"
PSRX-192W-24V	CLASS 2	11" X 4" X 1.82"
PSRX-200W-24V		10.24" X 4.13" X 1.77"
PSRX-288W-24V	CLASS 2	11.85" X 4.25" X 1.82"
PSRX-300W-24V		10.94" X 4.33" X 1.77"

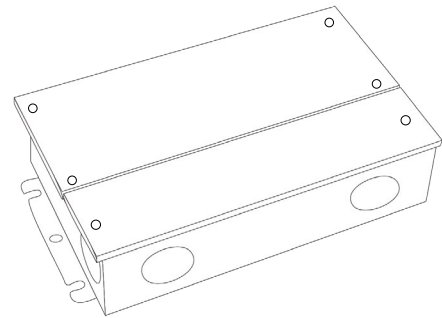

PSVT SERIES 0-10V DIMMING DRIVER

PSVT-60W-24V	CLASS 2	7.4" X 3.72" X 1.57"
PSVT-96W-24V	CLASS 2	8.66" X 3.72" X 1.57"
PSVT-200W-24V		10.24" X 4.13" X 1.77"
PSVT-288W-24V	CLASS 2	11.85" X 4.25" X 1.81"
PSVT-300W-24V		10.94" X 4.33" X 1.77"

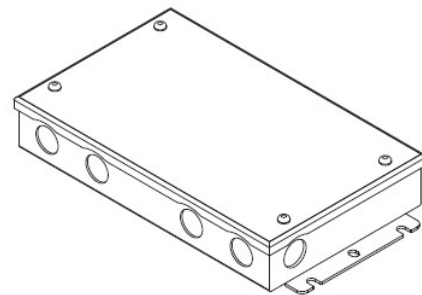

CURTAIN LED

RETICULAR LED SYSTEM

COMPATIBLE TRANSFORMERS

PSDE SERIES
0-10V DIMMING W/ JUNCTION BOX

PSDE-60W-24V-010-JB	CLASS 2	12.1" X 2.36" X 1.4"
PSDE-96W-24V-010-JB	CLASS 2	12.1" X 2.36" X 1.4"

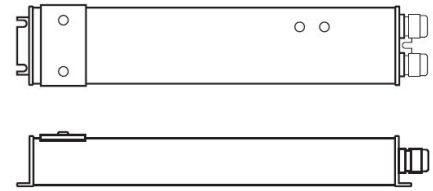

LUTRON 1%
3-WIRE DIMMING

L3DA4U1UKL-CV240	CLASS 2	4.89" X 4" X 2.62"
------------------	---------	--------------------

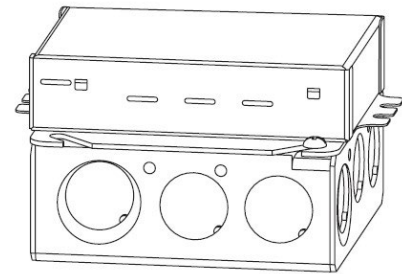

LUTRON 1%

PSDE-96W-24V-ECO	CLASS 2	10.5" X 3.0" X 2.0"
------------------	---------	---------------------

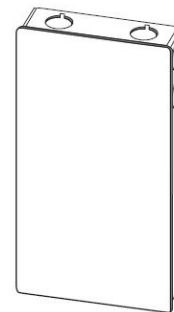

NON-DIMMING DRIVERS (COMPATABLE WITH ALL SYSTEMS)

PSHK SERIES
NON-DIMMING CONSTANT VOLTAGE WITH JUNCTION BOX

PSHK-30W-24V	CLASS 2	6.5" X 3.6" X 1.02"
PSHK-60W-24V	CLASS 2	7.4" X 3.62" X 1.02"
PSHK-96W-24V	CLASS 2	8.66" X 3.66" X 1.61"
PSHK-150W-24V		10.24" X 4.06" X 1.81"
PSHK-200W-24V		10.24" X 4.06" X 1.81"
PSHK-288W-24V	CLASS 2	11.85" X 4.25" X 1.82"
PSHK-300W-24V		10.24" X 4.25" X 1.81"

