

# LSM-15

## 1.5W INDOOR FLEXIBLE LED STRIP

Project \_\_\_\_\_

Location \_\_\_\_\_

Quote/ Ref # \_\_\_\_\_

**LSM-15** series is a great source of light for all indoor ambient lighting applications that allow you to transform your space into a desirable place for gathering. At 1.5 Watts per foot, this LED strip provides over 120 Lumens and is offered in a low profile design that can be attached almost anywhere.

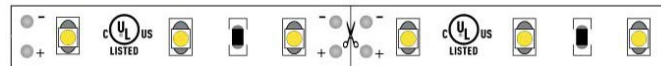

### SPECIFICATIONS

INPUT VOLTAGE	12V   24V DC
POWER CONSUMPTION	1.5W per Ft.
NO. OF LEDS	18 LEDs per Ft.
LUMEN OUTPUT	115 Lm/Ft. (3000K)
CRI	95+
COLOR TEMPERATURE	22K / 24K / 27K / 30K / 35K / 40K / 50K 60K / RD / BL / GR / PK / PR / AM / OR
DIMMING	MLV, ELV, 0-10 and TRIAC
MAXIMUM RUN LENGTH	16.4 Ft. (12V)   24 Ft. (24V)
CUTTABLE	Every 1.98" (50.22mm) (12V) Every 3.91" in. (99.27mm) (24V)
BINNING	1.5 Step Macadam Elipse
OPERATING TEMPERATURE	-40°F (-40°C) ~ +140°F (+60°C)
BEAM ANGLE	120°
IP RATING	Dry location (Indoor)
CERTIFICATIONS	UL Listed, TITLE 24 JA8
LUMEN MAINTENANCE	50,000 Hrs.

### LUMENS

CCT	LM/ FT	CRI	R9	R13
2700K	114	95	86	98
3000K	115	95	86	98
3500K	117	93	83	96
4000K	119	95	98	99
5000K	123	94	96	99
RED	49	-	-	-
GREEN	150	-	-	-
BLUE	33	-	-	-

\*Approved for closet / storage space installation per NEC 410.16(A)(3) and 410.16(C)(5)



MODEL	COLOR TEMP		LENGTH	VOLTAGE	PROFILE
LSM15	<b>22K</b> 2200K	<b>RD</b> Red	<b>16</b> 16 Ft.	<b>12V</b> 12V	See Page 3 for compatible profiles.
	<b>24K</b> 2400K	<b>BL</b> Blue	<b>100</b> 100 Ft.	<b>24V</b> 24V DC	
	<b>27K</b> 2700K	<b>GR</b> Green	<b>1XX</b> per Ft.		
	<b>30K</b> 3000K	<b>PK</b> Pink			
	<b>35K</b> 3500K	<b>PR</b> Purple			
	<b>40K</b> 4000K	<b>AM</b> Amber			
	<b>50K</b> 5000K	<b>OR</b> Orange			
	<b>60K</b> 6000K				

\*1 = Custom length per FT.  
(12V Strip cuttable every 1.98")  
(24V Strip cuttable every 3.91")

\* Custom color finishes require powder coating. Allow 7 days leads time.

# LSM-15

## 1.5W INDOOR FLEXIBLE LED STRIP

### DIMENSIONS

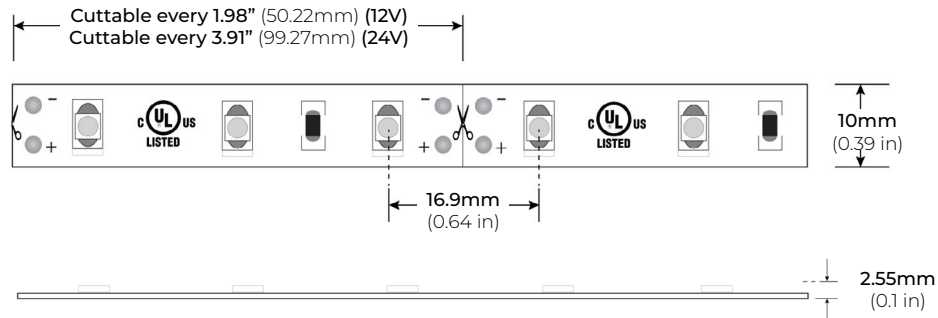

### COMPATIBLE CONNECTORS

#### HP PRO CONNECTORS

QUICK CONNECT SNAP-ON

- LSA-HW8-HP 8" HARDWIRE CONNECTOR
- LSA-HW24-HP 24" HARDWIRE CONNECTOR
- LSA-HW60-HP 60" HARDWIRE CONNECTOR
- LSA-HW120-HP 120" HARDWIRE CONNECTOR

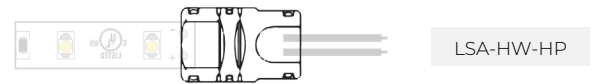

- LSA-EX3-HP 3" LINK
- LSA-EX8-HP 8" LINK
- LSA-EX24-HP 24" LINK

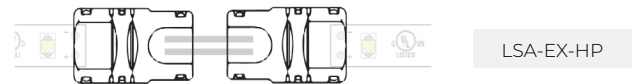

- LSA-MC-HP MINI COUPLING



- LSA-DC24-HP 24" DC CONNECTOR

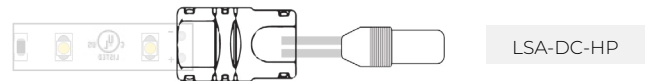

#### LSA-TB

SOLDERLESS LED STRIP/ WIRE BLOCK CONNECTOR

- LSA-TB-HWC 6 AMP HARDWIRE CONNECTOR
- LSA-TB-HWC-3A 3 AMP HARDWIRE CONNECTOR
- LSA-TB-MC STRIP TO STRIP
- LSA-TB-HWP-10A 3 AMP HARDWIRE CONNECTOR

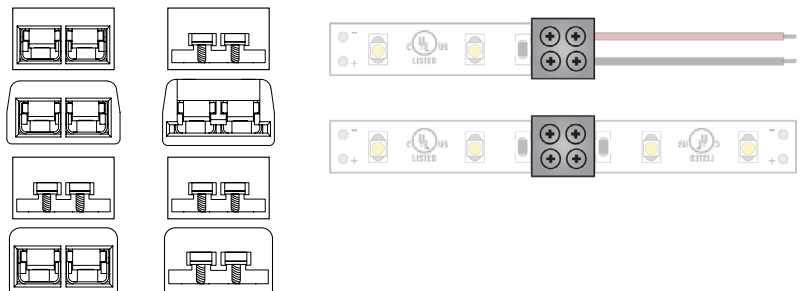

# LSM-15

## 1.5W INDOOR FLEXIBLE LED STRIP

### COMPATIBLE ALUMINUM PROFILES

#### SURFACE PROFILES

##### ALU-SF

LENGTHS 39" | 78" | 84" | 98"  
LENS Clear, Frosted  
FINISH Black | Silver

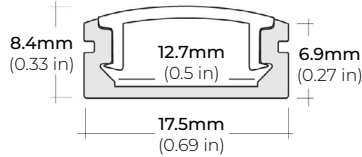

##### ALU-CN (CORNER)

LENGTHS 39" | 78" | 84" | 96"  
LENS Clear, Frosted  
FINISH Black | Silver

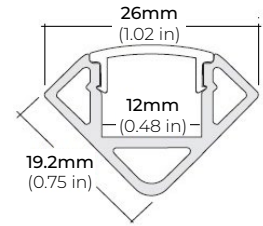

##### ALU-DS100

LENGTHS 39" | 78" | 84"  
LENS Clear, Frosted  
FINISH Silver

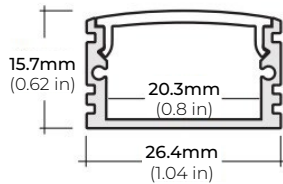

##### ALP-20

LENGTHS 49" | 84" | 98"  
LENS Frosted  
FINISH White | Black | Silver

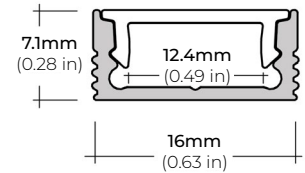

##### ALP-35

LENGTHS 49" | 98"  
LENS Frosted  
FINISH White | Black | Silver

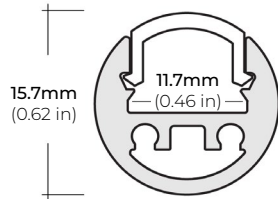

##### ALP-50C (CORNER)

LENGTHS 48" | 84" | 98"  
LENS Frosted  
FINISH White | Black | Silver

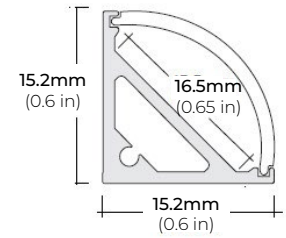

##### ALP-60

LENGTHS 49" | 84" | 98"  
LENS Frosted  
FINISH White | Black | Silver

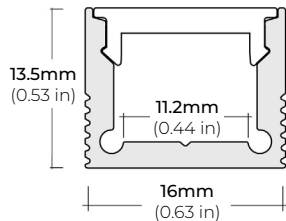

##### ALP-65

LENGTHS 48" | 96"  
LENS Clear  
FINISH Silver

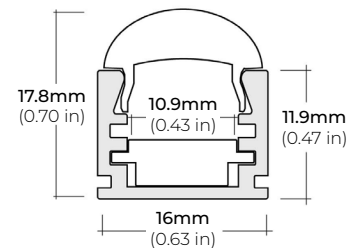

##### ALP-70

LENGTHS 49" | 84" | 98"  
LENS Frosted  
FINISH White | Black | Silver

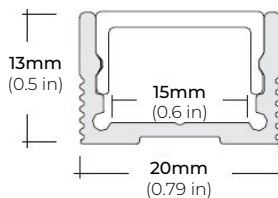

##### ALP-80

LENGTHS 49" | 98"  
LENS Frosted  
FINISH Silver

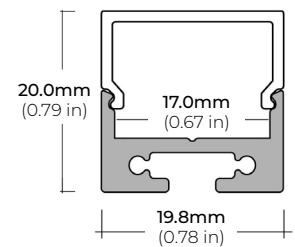

\* For more compatible profiles, visit [corelightingusa.com](http://corelightingusa.com)

#### RECESSED PROFILES

##### ALP-20R

LENGTHS 49" | 98"  
LENS Frosted  
FINISH White | Black | Silver

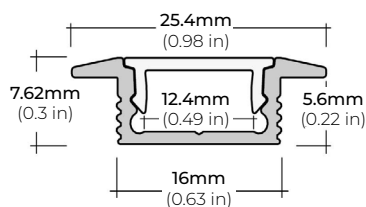

##### ALP-60R

LENGTHS 49" | 84" | 98"  
LENS Frosted  
FINISH White | Black | Silver

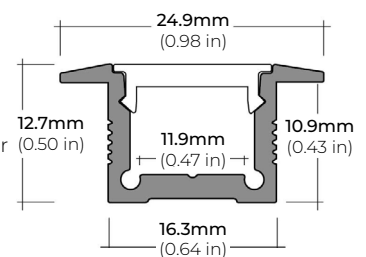

\* For more compatible profiles, visit [corelightingusa.com](http://corelightingusa.com)

# LSM-15

## 1.5W INDOOR FLEXIBLE LED STRIP

### COMPATIBLE TRANSFORMERS

#### PSDL SERIES TRIAC DIMMABLE

PSDL-30W-12V	CLASS 2	6.5" X 3.63" X 1.58"
PSDL-60W-12V	CLASS 2	7.4" X 3.63" X 1.58"
PSDL-100W-12V	CLASS 2	8.67" X 3.67 X 1.62"
PSDL-150W-12V		10.25" X 4.06" X 1.82"
PSDL-200W-12V		10.25" X 4.06" X 1.82"
PSDL-300W-12V		10.25" X 4.06" X 1.82"

PSDL-30W-24V	CLASS 2	6.5" X 3.63" X 1.58"
PSDL-60W-24V	CLASS 2	7.4" X 3.63" X 1.58"
PSDL-96W-24V	CLASS 2	8.67" X 3.67 X 1.62"
PSDL-150W-24V		10.25" X 4.06" X 1.82"
PSDL-192W-24V	CLASS 2	11" X 4" X 1.82"
PSDL-200W-24V		10.25" X 4.06" X 1.82"
PSDL-288W-24V	CLASS 2	11.85" X 4.25" X 1.82"
PSDL-300W-24V		10.25" X 4.06" X 1.82"

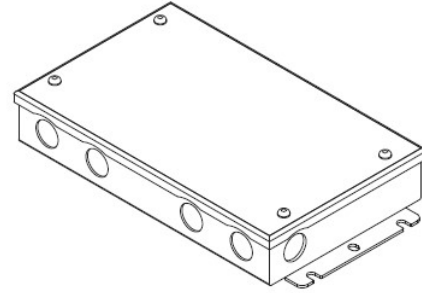

#### PSDH SERIES HIGH PERFORMANCE MAGNETIC LOW VOLTAGE (MLV)

PSDH-48W-24V	CLASS 2	11.25" X 3.38" X 3.38"
PSDH-96W-24V	CLASS 2	11.25" X 3.38" X 3.37"
PSDH-288W-24V	CLASS 2	14.25" X 8.43" X 4.43"

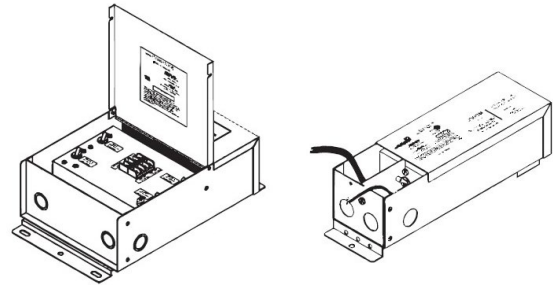

#### PSRX SERIES 4-IN-1 DIMMING DRIVER W/ JUNCTION BOX

PSRX-30W-12V-UNV	CLASS 2	6.5" X 3.72" X 1.57"
PSRX-60W-12V-UNV	CLASS 2	7.4" X 3.72" X 1.57"
PSRX-150W-12V-UNV		10.24" X 4.13" X 1.77"
PSRX-30W-24V-UNV	CLASS 2	6.5" X 3.7" X 1.57"
PSRX-60W-24V-UNV	CLASS 2	7.4" X 3.72" X 1.57"
PSRX-96W-24V-UNV	CLASS 2	8.66" X 3.72" X 1.57"
PSRX-150W-24V-UNV		10.24" X 4.13" X 1.77"
PSRX-200W-24V-UNV		10.24" X 4.13" X 1.77"
PSRX-300W-24V-UNV		10.94" X 4.33" X 1.77"

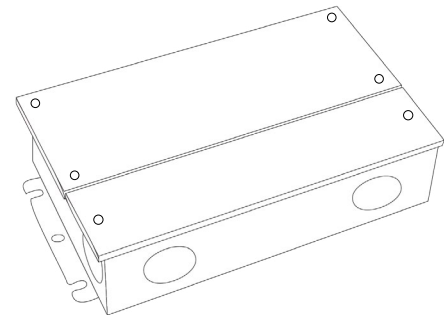

# LSM-15

## 1.5W INDOOR FLEXIBLE LED STRIP

### COMPATIBLE TRANSFORMERS

---

#### PSVT SERIES

0-10V DIMMING WITH JUNCTION BOX

PSVT-60W-24V-UNV-010	CLASS 2	7.4" X 3.72" X 1.57"
PSVT-96W-24V-UNV-010	CLASS 2	8.66" X 3.72" X 1.57"
PSVT-200W-24V-UNV-010		10.24" X 4.13" X 1.77"
PSVT-288W-24V-UNV-010	CLASS 2	11.85" X 4.25" X 1.81"
PSVT-300W-24V-UNV-010		10.94" X 4.33" X 1.77"

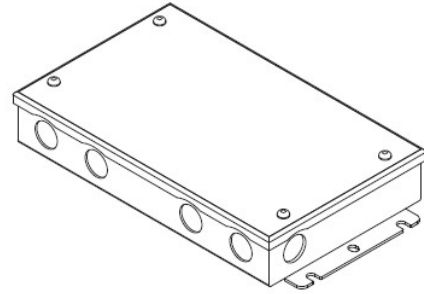

---

#### PSDE SERIES

0-10V DIMMING W/ JUNCTION BOX

PSDE-60W-24V-010-JB	CLASS 2	12.1" X 2.36" X 1.4"
PSDE-96W-24V-010-JB	CLASS 2	12.1" X 2.36" X 1.4"

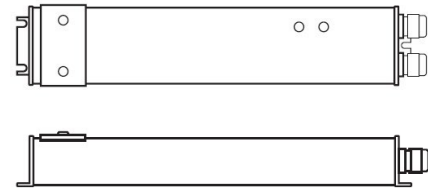

---

#### LUTRON 1%

3-WIRE DIMMING

L3DA4U1UKL-CV240	CLASS 2	4.89" X 4" X 2.62"
------------------	---------	--------------------

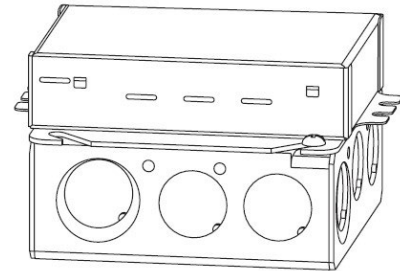

---

#### LUTRON 1%

PSDE-96W-24V-ECO	CLASS 2	10.5" X 3.0" X 2.0"
------------------	---------	---------------------

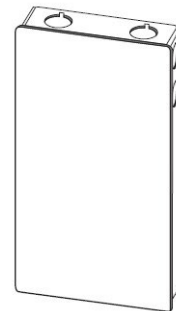

# LSM-15

## 1.5W INDOOR FLEXIBLE LED STRIP

### COMPATIBLE NON-DIMMING DRIVERS

#### PSHK SERIES

NON-DIMMING CONSTANT VOLTAGE WITH JUNCTION BOX

PSHK-30W-24V	CLASS 2	6.5" X 3.6" X 1.02"
PSHK-60W-24V	CLASS 2	7.4" X 3.62" X 1.02"
PSHK-96W-24V	CLASS 2	8.66" X 3.66" X 1.61"
PSHK-150W-24V		10.24" X 4.06" X 1.81"
PSHK-200W-24V		10.24" X 4.06" X 1.81"
PSHK-288W-24V	CLASS 2	11.85" X 4.25" X 1.82"
PSHK-300W-24V		10.94" X 4.25" X 1.81"

