

# LFO-40FX

## INDOOR/ OUTDOOR DUAL BEND LED STRIP

Project \_\_\_\_\_  
Location \_\_\_\_\_  
Quote/ Ref # \_\_\_\_\_

**LFO-40FX** is a dual bending linear LED strip that features the smallest, most discreet optical linear design. Easy to mount and install to nearly any surface and easily adaptable to almost any indoor or outdoor application. Its optics are ideal for grazing, wall washing, cove and other architectural or accent lighting applications.



### SPECIFICATIONS

INPUT VOLTAGE	24V DC
POWER CONSUMPTION	5.8W per Ft.
LUMEN OUTPUT	~500 Lm/ Ft.
NO. OF LEDS	8 LEDs/ Ft.
BEAM ANGLE	30°/ 60°/ 15°x50°/ 25°x45°/ 30°x50°
BENDING DIAMETER	4.7 in.
CRI	90+
COLOR TEMPERATURE	27K/ 30K/ 35K/ 40K/ Red/ Green/ Blue
DIMMING/ CONTROL	ELV, 0-10 and TRIAC
MAXIMUM RUN LENGTH	16 Ft.
CUTTABLE	Every 12 in
IP RATING	IP67 Outdoor/ Wet Rated
OPERATING TEMPERATURE	-22°F (-30°C) to 122°F (50°C)
LUMEN MAINTENANCE	50,000 Hrs.
CERTIFICATIONS	UL Listed, RoHS Compliant

### FEATURES

- Omnidirectional Bend
- Multiple Beam Options
- Multiple CCT Options
- UL Listed

### LUMENS

CCT	LM/ FT
2700K	480
3000K	480
3500K	522
4000K	558
RED	92
GREEN	230
BLUE	54



MODEL	COLOR TEMP	LENGTH	OPTICS	VOLTAGE	POWER FEED
LFO-40FX	<b>27K</b> 2700K	<b>RD</b> Red	<b>30</b> 30°	<b>24</b> 24V DC	<b>EF</b> End Feed
	<b>30K</b> 3000K	<b>GR</b> Green	<b>60</b> 60°		
	<b>35K</b> 3500K	<b>BL</b> Blue	<b>15x50</b> 15° x 50°		
	<b>40K</b> 4000K		<b>25x45</b> 25° x 45°		
			<b>30x50</b> 30° x 50°		
		*1 = Custom length per FT. (cuttable every 12")			

# LFO-40FX

## INDOOR/ OUTDOOR DUAL BEND LED STRIP

### DIMENSIONS

#### TOP VIEW

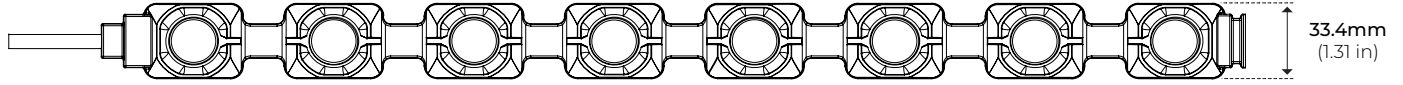

#### SIDE VIEW

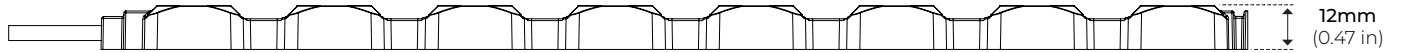

### MOUNTING ACCESSORIES

#### LFO40-MB MOUNTING CLIP

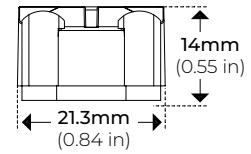

#### LFO40-AMC ANGLED MOUNTING CLIP

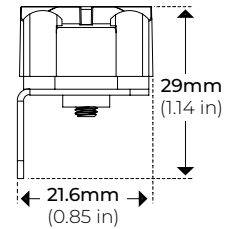

#### LFO40-MCU U-TYPE MOUNTING CLIP

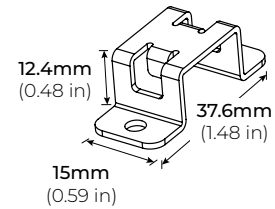

### COMPATIBLE ACCESSORIES

#### LFO40-SDLV SYMMETRICAL LOUVER

\* Sold Separately

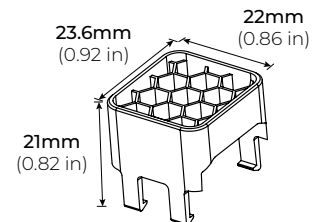

# LFO-40FX

## INDOOR/ OUTDOOR DUAL BEND LED STRIP

### COMPATIBLE TRANSFORMERS

#### PSDL SERIES TRIAC DIMMABLE

PSDL-30W-24V	CLASS 2	6.5" X 3.63" X 1.03"
PSDL-60W-24V	CLASS 2	7.4" X 3.63" X 1.03"
PSDL-96W-24V	CLASS 2	8.67" X 3.67 X 1.62"
PSDL-150W-24V		8.67" X 3.67" X 1.62"
PSDL-192W-24V	CLASS 2	10.25" X 4.06" X 1.82"
PSDL-200W-24V		10.25" X 4.06" X 1.82"
PSDL-288W-24V	CLASS 2	10.25" X 4.06" X 1.82"
PSDL-300W-24V		10.25" X 4.06" X 1.82"

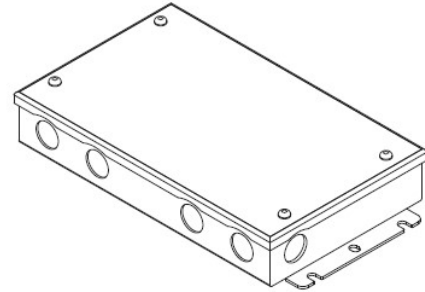

#### PSRX SERIES 4-IN-1 DIMMING DRIVER

PSRX-30W-24V	CLASS 2	6.5" X 3.72" X 1.57"
PSRX-60W-24V	CLASS 2	7.4" X 3.72" X 1.57"
PSRX-96W-24V	CLASS 2	8.66" X 3.72" X 1.57"
PSRX-150W-24V		10.24" X 4.13" X 1.77"
PSRX-192W-24V	CLASS 2	11" X 4" X 1.82"
PSRX-200W-24V		10.24" X 4.13" X 1.77"
PSRX-288W-24V	CLASS 2	11.85" X 4.25" X 1.82"
PSRX-300W-24V		10.94" X 4.33" X 1.77"

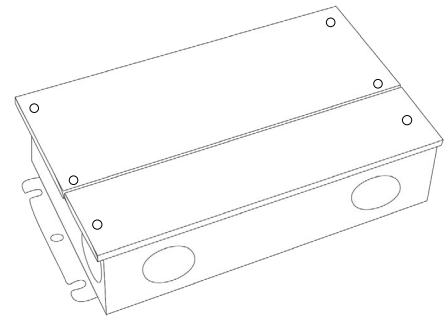

#### PSVT SERIES 0-10V DIMMING DRIVER

PSVT-60W-24V	CLASS 2	7.4" X 3.72" X 1.57"
PSVT-96W-24V	CLASS 2	8.66" X 3.72" X 1.57"
PSVT-200W-24V		10.24" X 4.13" X 1.77"
PSVT-288W-24V	CLASS 2	11.85" X 4.25" X 1.81"
PSVT-300W-24V		10.94" X 4.33" X 1.77"

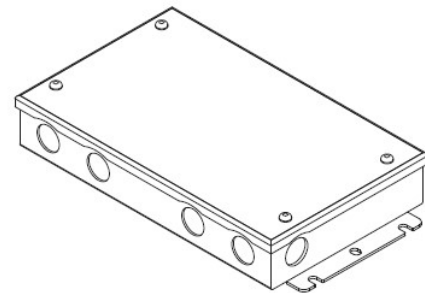

#### PSDE SERIES 0-10V DIMMING W/ JUNCTION BOX

PSDE-60W-24V-010-JB	CLASS 2	12.1" X 2.36" X 1.4"
PSDE-96W-24-010-JB	CLASS 2	12.1" X 2.36" X 1.4"

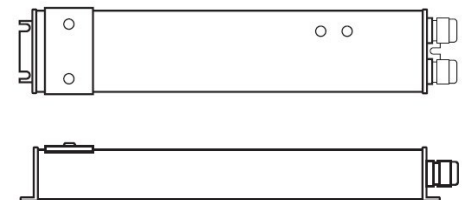

# LFO-40FX

## INDOOR/ OUTDOOR DUAL BEND LED STRIP

### COMPATIBLE TRANSFORMERS

LUTRON 1%  
3-WIRE DIMMING

L3DA4UTUKL-CV240      CLASS 2    4.89" X 4" X 2.62"

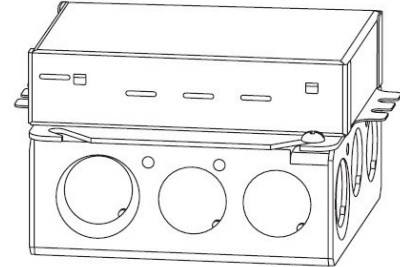

PSDE-96W-24V-ECO      CLASS 2    10.5" X 3.0" X 2.0"

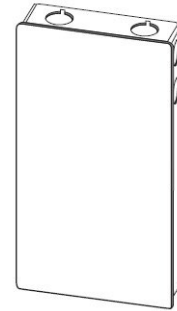

### COMPATIBLE NON-DIMMING DRIVERS

PSHK SERIES  
NON-DIMMING CONSTANT VOLTAGE WITH JUNCTION BOX

PSHK-30W-24V	CLASS 2	6.5" X 3.6" X 1.02"
PSHK-60W-24V	CLASS 2	7.4" X 3.62" X 1.02"
PSHK-96W-24V	CLASS 2	8.66" X 3.66" X 1.61"
PSHK-150W-24V		10.24" X 4.06" X 1.81"
PSHK-200W-24V		10.24" X 4.06" X 1.81"
PSHK-288W-24V	CLASS 2	11.85" X 4.25" X 1.82"
PSHK-300W-24V		10.24" X 4.25" X 1.81"

