

INSTALLATION GUIDE

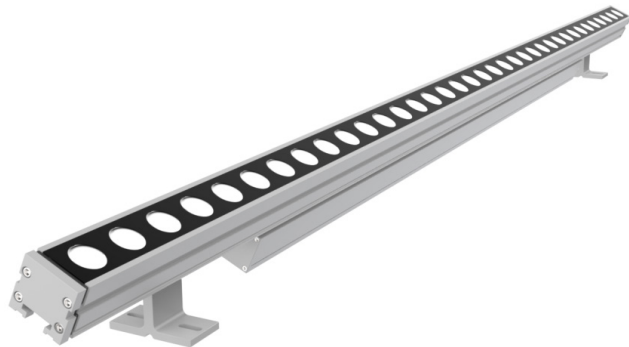

DIMENSIONS

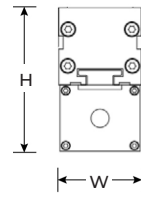

LWW120-SL

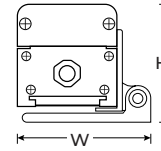

LWW120-HO

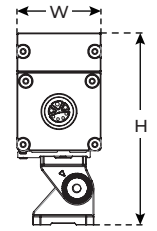

LWW120-VHO

MODEL	WIDTH	HEIGHT
LWW120-SL	35.8mm	67.7mm
LWW120-HO	80.5mm	70.5mm
LWW120-VHO	55mm	126mm



PRE-INSTALLATION

Surface Mount

Disconnect power source prior to installation.

SAFETY

Read all instructions before installation.

These products may present a possible shock, serious injury, or death if improperly installed.

Do not install within 10 ft or less from the nearest edge of a pool, spa, fountain, or similar location



Product should be installed by a qualified electrician.



Product should be installed in accordance with these instructions and current electrical codes.

INSTALLATION

- STEP 1 Position fixture and mark the screw hole locations. Pre-drill as needed.
- STEP 2 Locate the marked or pre-drilled holes. Re-position fixture on one side to expose the the holes. Attach with appropriate hardware.
- STEP 3 Rotate fixture to opposite side to expose remaining holes. Attach with appropriate hardware.
- STEP 4 Rotate fixture back to proper position. Tighten pivot bolt to secure the desired angle.
- STEP 5 Connect each desired fixture using the provided connectors and cables.
- STEP 6 Connect the starting fixture to the source voltage line.
**Make sure an end cap is placed on the final, unused cable connector.*

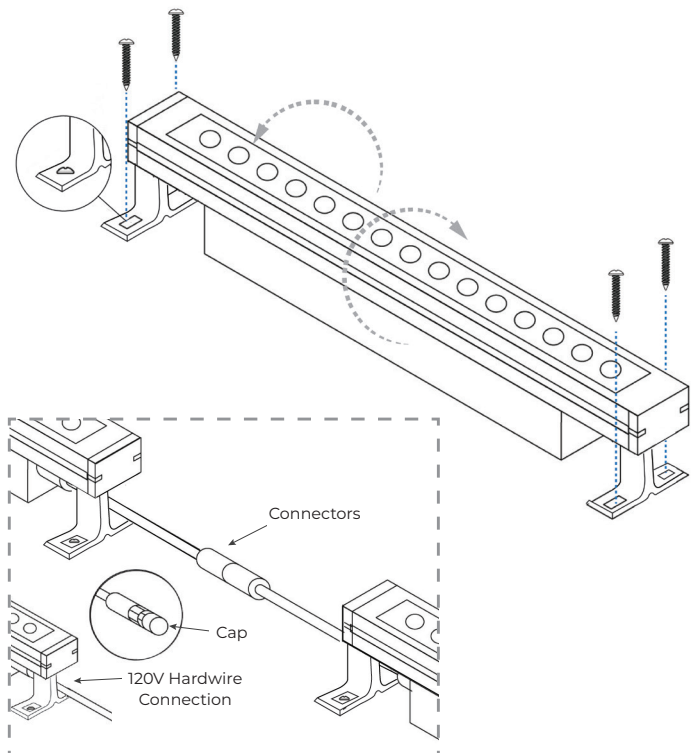

INSTALLATION GUIDE

DIMENSIONS

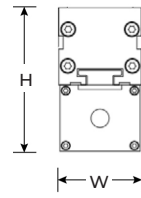
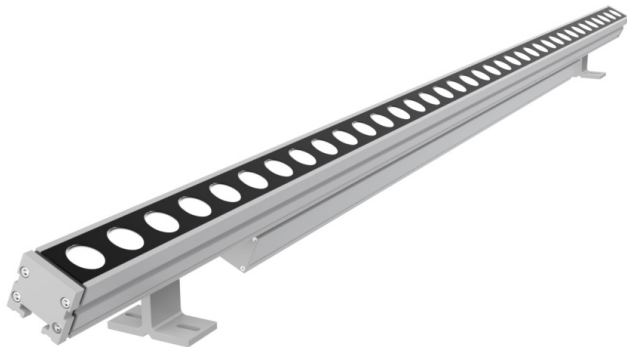

LWW120-SL

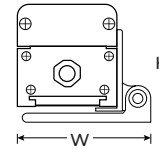

LWW120-HO

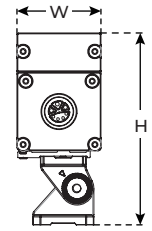

LWW120-VHO

MODEL	WIDTH	HEIGHT
LWW120-SL	35.8mm	67.7mm
LWW120-HO	80.5mm	70.5mm
LWW120-VHO	55mm	126mm



PRE-INSTALLATION

Surface Mount

Disconnect power source prior to installation.

SAFETY

Read all instructions before installation.

These products may present a possible shock, serious injury, or death if improperly installed.



Product should be installed by a qualified electrician.



Product should be installed in accordance with these instructions and current electrical codes.

WALL MOUNT ARMS INSTALLATION

LWW-WMA

STEP 1 Mount one extension arm onto wall. Make sure to check that the proper distance is allocated then mount the other extension arm. (Figure 1)
**Fasten securely, making sure the extension arms are not wiggling or loose.*

STEP 2 Adjust extension arm length by loosening the hex screws and extending the inner channel to the desired length. Tighten the hex screws to set the length. (Figure 2)

STEP 3 Tilt fixture to one side to expose the screw holes on one side of the adjustable brackets. Fasten the M4 screws securely. Tilt fixture in the opposite direction and fasten M4 screws on the other side. (Figure 3)

STEP 4 Connect each desired fixture using the provided connectors and cables.

STEP 5 Connect the starting fixture to the source voltage line.
**Make sure an end cap is placed on the final, unused cable connector.*

