

LFO-90

5W INDOOR/ OUTDOOR LINEAR OPTICAL LED STRIP

Project _____

Location _____

Quote/ Ref # _____

LFO-90 is a 24V flexible indoor and outdoor optical LED strip. With its unique design, the LFO-90 is able to bend horizontally or vertically, making it easy to create customized lighting arrangements. Its linear design and multiple angle options are ideal for creating a dramatic accent wall or simply adding a touch of warmth to your living space. Available in multiple color temperatures, this LED strip is the perfect choice for your decorative lighting needs.



SPECIFICATIONS

POWER CONSUMPTION	5W per Ft.
LUMEN OUTPUT	333 - 400 Lumens per Ft.
CRI	90+
COLOR TEMPERATURE	27K/ 30K/ 35K/ 40K/ 50K
DIMMING/ CONTROL	MLV, ELV, 0-10 and TRIAC
MAXIMUM RUN LENGTH	33 Ft.
CUTTABLE	Every 1.5 in. (38.1mm)
OPERATING VOLTAGE	24V DC
STORAGE TEMPERATURE	-22°F (-30°C) to +176°F (+80°C)
OPERATING TEMPERATURE	-4°F (-20°C) to +122°F (+50°C)
BEAM ANGLE	15°/ 25°/ 45°/ 60°
IP RATING	IP67
CERTIFICATIONS	CE, RoHS
LUMEN MAINTENANCE	50,000 Hrs.

FEATURES

- 5W/ Ft.
- 24V DC
- 90+ CRI
- Continuous Run up to 33 Ft.
- Flexible, Silicone encapsulated
- Dimmable with CORE Lighting dimmable drivers
- Field Cuttable
- CE, RoHS



MODEL	COLOR TEMP	OPTIC	LENGTH	VOLTAGE	POWER FEED
LFO-90	27K 2700K	15 15°	1'XX per Ft.	24 24V DC	IP67BF Bottom Feed
	30K 3000K	25 25°			IP67SFL Side Feed Left
	35K 3500K	45 45°			IP67SFR Side Feed Right
	40K 4000K	60 60°			IP67EF End Feed
	50K 5000K				

*1 = Custom length per FT. (cuttable every 1.5")

LFO-90

5W INDOOR/ OUTDOOR LINEAR OPTICAL LED STRIP

DIMENSIONS

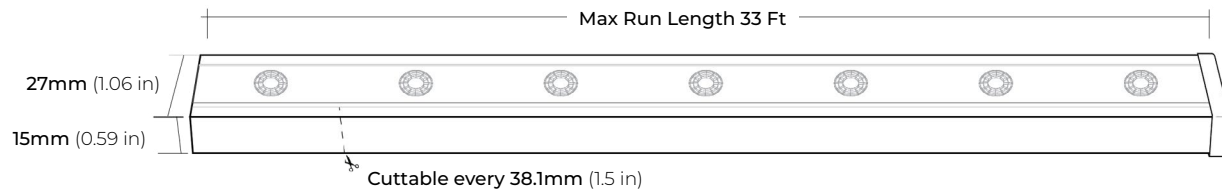

COMPATIBLE ACCESSORIES

LFO-90-MB
ALUMINUM MOUNTING CLIP
50 X 31.1 X 21.5mm (L x W x H)



LFO-90-AC39
ALUMINUM PROFILE
1000 X 31.1 X 21.5mm (L x W x H)



LFO-90-FX39
STAINLESS STEEL BENDABLE PROFILE
1000 X 28.2 X 19mm (L x W x H)

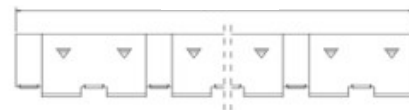

LFO-90

5W INDOOR/ OUTDOOR LINEAR OPTICAL LED STRIP

IP67 POWER FEED

IP67BF
BOTTOM FEED

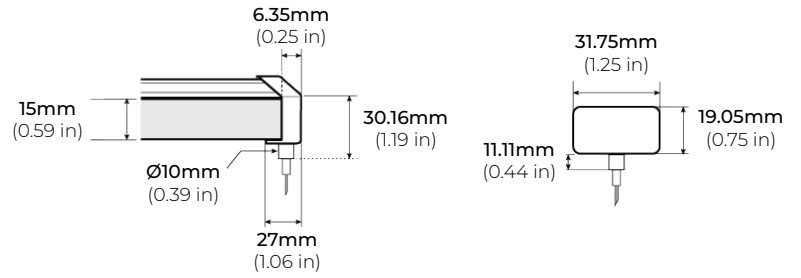

IP67FL
SIDE LEFT FEED

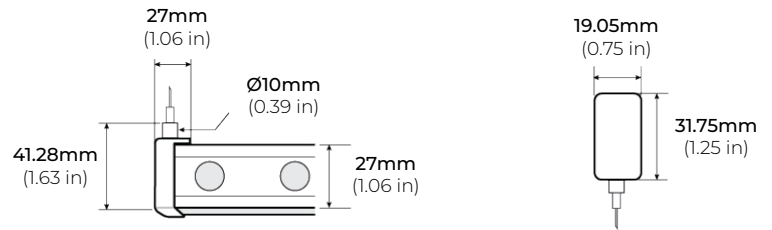

IP67FR
SIDE RIGHT FEED

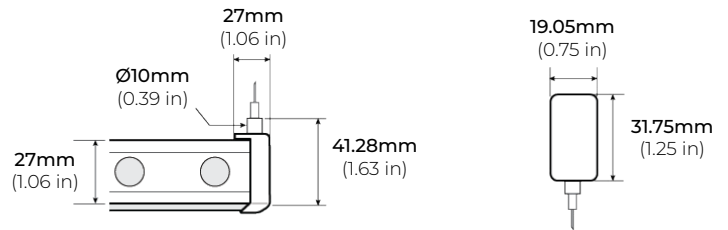

IP67EF
END FEED

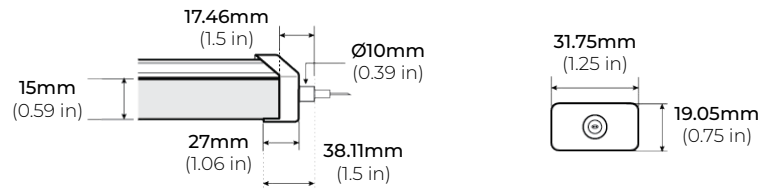

LFO-90

5W INDOOR/ OUTDOOR LINEAR OPTICAL LED STRIP

COMPATIBLE TRANSFORMERS

PSDL SERIES TRIAC DIMMABLE

PSDL-30W-24V	CLASS 2	6.5" X 3.63" X 1.03"
PSDL-60W-24V	CLASS 2	7.4" X 3.63" X 1.03"
PSDL-96W-24V	CLASS 2	8.67" X 3.67 X 1.62"
PSDL-150W-24V		8.67" X 3.67" X 1.62"
PSDL-192W-24V	CLASS 2	10.25" X 4.06" X 1.82"
PSDL-200W-24V		10.25" X 4.06" X 1.82"
PSDL-288W-24V	CLASS 2	10.25" X 4.06" X 1.82"
PSDL-300W-24V		10.25" X 4.06" X 1.82"

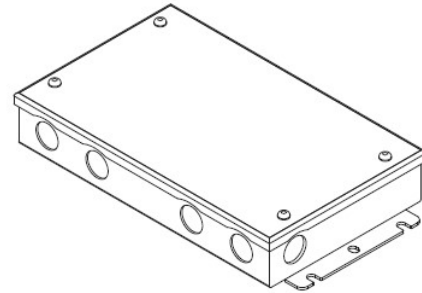

PSDH SERIES HIGH PERFORMANCE MAGNETIC LOW VOLTAGE (MLV)

PSDH-48W-24V	CLASS 2	11.25" X 3.37" X 3.25"
PSDH-96W-24V	CLASS 2	11.25" X 3.37" X 3.25"
PSDH-288W-24V	CLASS 2	14.25" X 8.43" X 4.43"

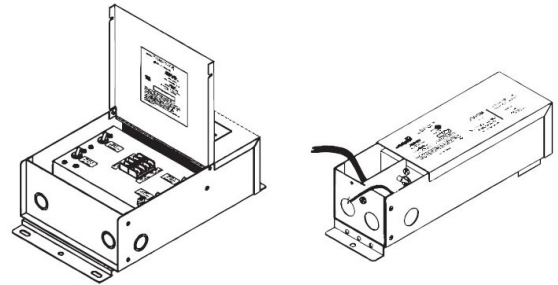

PSRX SERIES 4-IN-1 DIMMING DRIVER

PSRX-30W-24V	CLASS 2	6.5" X 3.72" X 1.57"
PSRX-60W-24V	CLASS 2	7.4" X 3.72" X 1.57"
PSRX-96W-24V	CLASS 2	8.66" X 3.72" X 1.57"
PSRX-150W-24V		10.24" X 4.13" X 1.77"
PSRX-192W-24V	CLASS 2	11" X 4" X 1.82"
PSRX-200W-24V		10.24" X 4.13" X 1.77"
PSRX-288W-24V	CLASS 2	11.85" X 4.25" X 1.82"
PSRX-300W-24V		10.94" X 4.33" X 1.77"

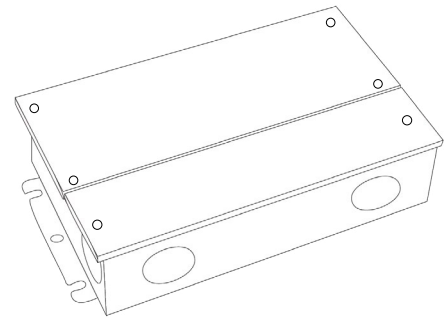

PSVT SERIES 0-10V DIMMING DRIVER

PSVT-60W-24V	CLASS 2	7.4" X 3.72" X 1.57"
PSVT-96W-24V	CLASS 2	8.66" X 3.72" X 1.57"
PSVT-200W-24V		10.24" X 4.13" X 1.77"
PSVT-288W-24V	CLASS 2	11.85" X 4.25" X 1.81"
PSVT-300W-24V		10.94" X 4.33" X 1.77"

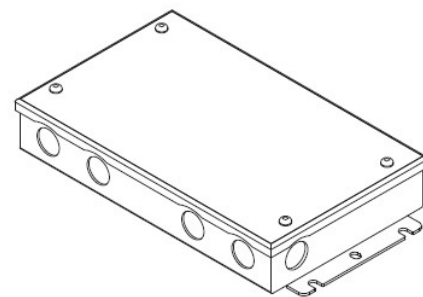

LFO-90

5W INDOOR/ OUTDOOR LINEAR OPTICAL LED STRIP

COMPATIBLE TRANSFORMERS

PSDE SERIES

0-10V DIMMING W/ JUNCTION BOX

PSDE-60W-24V-010-JB	CLASS 2	12.1" X 2.36" X 1.4"
PSDE-96W-24V-010-JB	CLASS 2	12.1" X 2.36" X 1.4"

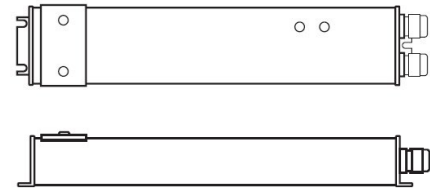

LUTRON 1%

3-WIRE DIMMING

L3DA4U1UKL-CV240	CLASS 2	4.89" X 4" X 2.62"
------------------	---------	--------------------

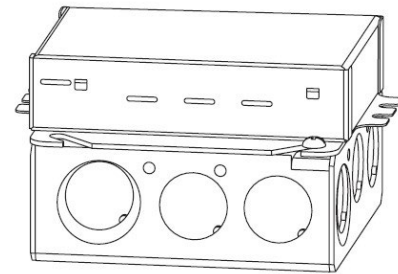

LUTRON 1%

PSDE-96W-24V-ECO	CLASS 2	10.5" X 3.0" X 2.0"
------------------	---------	---------------------

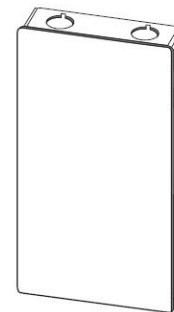

NON-DIMMING DRIVERS (COMPATABLE WITH ALL SYSTEMS)

PSHK SERIES

NON-DIMMING CONSTANT VOLTAGE WITH JUNCTION BOX

PSHK-30W-24V	CLASS 2	6.5" X 3.6" X 1.02"
PSHK-60W-24V	CLASS 2	7.4" X 3.62" X 1.02"
PSHK-96W-24V	CLASS 2	8.66" X 3.66" X 1.61"
PSHK-150W-24V		10.24" X 4.06" X 1.81"
PSHK-200W-24V		10.24" X 4.06" X 1.81"
PSHK-288W-24V	CLASS 2	11.85" X 4.25" X 1.82"
PSHK-300W-24V		10.24" X 4.25" X 1.81"

